



XDH/XLH series PLC

User manual [Motion control]

Wuxi Xinje Electric Co., Ltd.

Data No. PD11 20210812 1.0

Basic notes

- ◆ Thank you for purchasing Xinje XDH and XLH series PLC.
- ◆ This manual mainly introduces the motion control function of XDH and XLH series PLC.
- ◆ Before using the product, please read this manual carefully and operate on the premise of fully understanding the contents of the manual.
- ◆ For the introduction of software and programming, please refer to the relevant manuals.
- ◆ Please deliver this manual to the end user.

User instructions

- ◆ Only operators with certain electrical knowledge can carry out wiring and other operations on the product. If there are any unknown cases, please consult our technicians.
- ◆ The examples listed in the manual and other technical materials are only for users' understanding and reference, and do not guarantee certain actions.
- ◆ When using this product in combination with other products, please confirm whether it complies with relevant specifications and principles.
- ◆ When using this product, please confirm whether it meets the requirements and is safe.
- ◆ Please set up backup and safety functions by yourself to avoid possible machine failure or loss caused by the failure of this product.

Statement of responsibility

- ◆ Although the contents of the manual have been carefully checked, errors are inevitable, and we can't guarantee complete consistency.
- ◆ We will often check the contents of the manual and correct them in subsequent versions. We welcome your valuable comments.
- ◆ Please understand that the contents described in the manual are subject to change without notice.

Contact method

If you have any questions about the use of this product, please contact the agent and office who purchased the product, or directly contact Xinje company.

- ◆ Telephone: 400-885-0136
- ◆ Fax: 0510-85111290
- ◆ Address: 4th floor, building 7, creative industry park, No. 100, Dicui Road, Wuxi, China
- ◆ Post code: 214072
- ◆ Website: www.xinje.com

WUXI XINJE ELECTRIC CO., LTD. All rights reserved

This material and its contents shall not be copied, transmitted or used without explicit written permission. Violators shall be liable for the losses caused. All rights provided in the patent license and registration including utility modules or designs are reserved.

August, 2021

Catalog

PREFACE	VI
1. ETHERCAT TECHNICAL OVERVIEW	1
1-1. ETHERCAT OVERVIEW	1
1-2. SYSTEM COMPOSITION (MASTER AND SLAVE STATION)	1
1-3. COMMUNICATION SPECIFICATION	1
1-4. ETHERCAT COMMUNICATION CONNECTION	2
2. ETHERCAT COMMUNICATION SPECIFICATION	3
2-1. ETHERCAT FRAME STRUCTURE.....	3
2-2. ESM (ETHERCAT STATE MACHINE)	4
2-3. SLAVE STATION CONTROLLER ESC	5
2-3-1. Principle overview	5
2-3-2. Address space.....	5
2-4. SII AREA (0000H~003FH).....	7
2-5. SDO (SERVICE DATA OBJECT).....	7
2-5-1. Mailbox frame structure	7
2-5-2. Mailbox overtime.....	8
2-5-3. Alarm information.....	8
2-6. PDO (PROCESS DATA OBJECT).....	9
2-6-1. PDO mapping objects.....	9
2-6-2. PDO distribution objects	9
2-7. COMMUNICATION SYNCHRONIZATION MODE	10
2-7-1. DC (SYNC0 Event synchronization)	10
2-7-2. SM2 (SM2 Event synchronization).....	11
2-8. LED LIGHT.....	11
3. ETHERCAT PARAMETER CONFIGURATION	12
3-1. ETHERCAT CONFIGURATION INTERFACE	12
3-2. MASTER STATION CONFIGURATION	13
3-3. SLAVE STATION LIST	14
3-4. SLAVE STATION CONFIGURATION	15
3-5. GENERAL	16
3-6. EXPERT PROCESS DATA	18
3-7. LAUNCH PARAMETER	19
3-8. IO MAPPING.....	20
3-9. COE-ONLINE INTERFACE	22
3-10. ESC REGISTER.....	23
4. OBJECT DICTIONARY (COE-ONLINE)	24
4-1. OBJECT DICTIONARY AREA ASSIGNMENT	24
4-2. COE COMMUNICATION AREA (0X1000-0X1FFF).....	24
4-2-1. Object list.....	24
4-2-2. Device information	27
4-2-3. Sync manager communication type (1C00h)	28
4-2-4. PDO mapping.....	29
4-2-5. Sync manager 2/3 synchronization (1C32h, 1C33h)	31
4-3. DRIVER PROFILE AREA (0X6000~0X6FFF).....	35
4-3-1. Object list.....	35
4-3-2. PDS (Power Drive Systems) specification	37
4-3-3. Controlword (6040h)	38
4-3-4. Statusword (6041h).....	39
4-3-5. Control mode setting.....	40
5. MOTION INSTRUCTION	43
5-1. SINGLE AXIS FUNCTION	43
5-1-1. Instruction list.....	43
5-1-2. Instructions	44
5-1-2-1. Axis enable 【A_PWR】	44
5-1-2-2. Error reset 【A_RST】	46

5-1-2-3. Modify the electrical position 【A_WRITE】	48
5-1-2-4. Modify the control mode 【A_MODE】	52
5-1-2-5. Stop motion 【A_STOP】	55
5-1-2-6. Pause 【A_HALT】	58
5-1-2-7. Absolute position motion 【A_MOVEA】	60
5-1-2-8. Relative position motion 【A_MOVER】	65
5-1-2-9. Absolute position continuous motion 【A_CMOVEA】	70
5-1-2-10. Relative position continuous motion 【A_CMOVER】	75
5-1-2-11. Speed control motion 【A_VELMOVE】	80
5-1-2-12. Superposition motion 【A_MOVESUP】	84
5-1-2-13. HM homing 【A_HOME】	88
5-1-2-14. Homing 【A_ZRN】	99
5-1-2-15. Gear binding 【A_GEARIN】	109
5-1-2-16. Gear unbinding 【A_GEAROUT】	114
5-1-2-17. Simple absolute position motion 【A_DRVA】	119
5-1-2-18. Simple relative position motion 【A_DRVI】	123
5-1-2-19. Probe function 【A_PROBE】	127
5-1-2-20. Periodic position control motion 【A_CYCPOS】	133
5-1-2-21. Periodic speed control motion 【A_CYCVEL】	135
5-1-2-22. Periodic torque control motion 【A_CYCTRQ】	139
5-1-3. Related coil and register	143
5-2. AXIS GROUP FUNCTION.....	151
5-2-1. Command list.....	151
5-2-2. Command introduction	152
5-2-2-1. Axis group enable 【G_PWR】	152
5-2-2-2. Modify the composition axis 【G_CFGAXIS】	155
5-2-2-3. Point to point motion 【G_PTP】	157
5-2-2-4. Linear interpolation 【G_LINE】	161
5-2-2-5. Circular interpolation 【G_CIRCLE】	166
5-2-2-6. Spiral motion 【G_HELICAL】	171
5-2-2-7. Superimposed motion 【G_MOVSUP】	194
5-2-2-8. Compensation motion 【G_COMPON】	199
5-2-2-9. Compensation cancellation 【G_COMPOFF】	204
5-2-2-10. Interrupt motion 【G_INTR】	206
5-2-2-11. Continue the motion 【G_GOON】	208
5-2-2-12. Specified path mode selection 【G_PATHMODE】	210
5-2-2-13. Select machining path 【G_PATHSEL】	212
5-2-2-14. Path motion 【G_PATHMOV】	217
5-2-2-15. Modify the multiplying power 【G_SETOVRD】	222
5-2-3. Related coil and register	226
5-3. CAM FUNCTION	231
5-3-1. Command list.....	231
5-3-2. Command introduction	232
5-3-2-1. Cam table loading 【CAMTBLSEL】	232
5-3-2-2. CAM start 【CAMIN】	234
5-3-2-3. CAM release 【CAMOUT】	242
5-3-2-4. Phase compensation 【CAMPHASE】	244
5-3-2-5. CAM table read 【CAMRD】	246
5-3-2-7. Add key point 【CAMPOINTADD】	250
5-3-2-8. Key point delete 【CAMPOINTDEL】	252
5-3-2-9. CAM table unload 【CAMTBLDEL】	254
5-3-3. CAM configuration in the software.....	256
5-3-3-1. Open the cam table configuration	256
5-3-3-2. Create a new CAM table.....	256
5-3-3-3. Add the cam table point.....	257
5-3-3-4. Export the cam table.....	259
6. MOTION COMMAND APPLICATION.....	260

6-1. SINGLE AXIS FUNCTION APPLICATION	260
6-2. AXIS GROUP FUNCTION APPLICATION	264
6-3. CAM FUNCTION APPLICATION	267
6-4. PULSE CHANNEL APPLICATION	276
6-5. FULL CLOSED-LOOP FUNCTION APPLICATION	277
7. BUS MOTION CONTROL FUNCTION CHOICE	280
7-1. H MOTION/C MOTION	280
7-2. SOFTWARE CONFIGURATION	280
8. MOTION CONTROL CONFIGURATION INTERFACE	281
8-1. AXIS CONFIGURATION	281
8-2. AXIS MONITOR AND DEBUG	284
8-3. AXIS GROUP CONFIGURATION	285
9. OSCILLOSCOPE FUNCTION	288
9-1. OPERATING CONDITIONS OF OSCILLOSCOPE	288
9-2. OPEN THE OSCILLOSCOPE	288
9-3. OSCILLOSCOPE MAIN INTERFACE	288
9-4. OSCILLOSCOPE CONFIGURATION INTERFACE	290
9-4-1. Oscilloscope type configuration	290
9-4-2. Axis variable configuration	290
9-4-3. Register configuration	291
9-4-4. Cursor configuration	291
9-4-5. Difference interface	292
9-4-6. Trigger configuration	293
9-4-7. Oscilloscope application	294
10. ETHERCAT INSTRUCTION	298
10-1. SDO READ [EC_SDORD]	298
10-2. SDO WRITE [EC_SDOWR]	301
10-3. ESC READ [EC_REGRD]	304
10-4. ESC WRITE [EC_ESCWR]	307
10-5. ESM STATUS SWITCH [EC_SETSS]	310
APPENDIX	311
APPENDIX 1. COMMAND ERROR CODE	311
APPENDIX 2. REGISTER AND COIL DISTRIBUTION	319
APPENDIX 3. SERVO DRIVER GROUP U PARAMETERS	320
APPENDIX 4. ETHERCAT COMMUNICATION RELATED SERVO DRIVER ALARM	324
Appendix 4-1. Alarm list	324
Appendix 4-3. Clear the alarm	327
APPENDIX 5. PHRASEOLOGY	328
APPENDIX 6. LIST OF OBJECT DICTIONARIES	329
Appendix 6-1. COE communication area (0x1000-0x1FFF)	329
Appendix 6-2. Servo parameter area	331
Appendix 6-3. Servo driver Profile area (0x6000~0x6FFF)	331
APPENDIX 7. KEY POINTS FOR ATTENTION	335

Preface

This manual is XDH / XLH series PLC [motion control], which mainly introduces the upgraded motion control function, which is applicable to XDH and XLH series PLC.

Note: please confirm that the value of SFD811 is 1 before using the relevant instructions in this manual (SFD811 parameter setting please refer to chapter 5-1-3).

1. EtherCAT technical overview

1-1. EtherCAT overview

EtherCAT, fully known as Ethernet for control automation technology, developed by Beckhoff automation GmbH, is a real-time Ethernet used for open network communication between master station and slave station. As a mature industrial Ethernet technology, EtherCAT has the characteristics of high performance, low cost and easy use.

XDH, XLH series controller (master station) and DS5C servo driver (slave station) comply with the standard EtherCAT protocol, support the maximum 32-axis slave stations, 32-axis synchronization cycle of 1ms, 2-channel touch probe function, position, speed, torque and other control modes, and are widely applicable to various industrial applications.

1-2. System composition (master and slave station)

The connection form of EtherCAT is the network system of linear connection master station (FA controller) and multiple slave stations.

The number of nodes that can be connected by the slave station depends on the processing or communication period of the master station, the number of bytes transmitted, etc.

1-3. Communication specification

Item	Specification																				
Physical layer	100BASE-TX (IEEE802.3)																				
Baud rate	100[Mbps] (full duplex)																				
Topology	Line																				
Connection cable	JC-CA twisted pair (shielded twisted pair)																				
Cable length	Maximum 50m between nodes																				
Com port	2 Port (RJ45)																				
EtherCAT Indicators (LED)	[Run] RUN Indicator [L/A IN] Port0 Link/Activity Indicator (Green) [L/A OUT] Port1 Link/Activity Indicator (Green)																				
Station Alias (ID)	Setting range: 0~65535 Setting address: 2700h																				
Explicit Device ID	Not support																				
Mailbox protocol	COE (CANopen Over EtherCAT)																				
SyncManager	4																				
FMMU	3																				
Modes of operation	<table border="1"> <thead> <tr> <th></th> <th colspan="2">Modes of operation</th> </tr> </thead> <tbody> <tr> <td rowspan="3">position</td> <td>csp</td> <td>Cyclic synchronous position mode</td> </tr> <tr> <td>PP</td> <td>Profile position mode</td> </tr> <tr> <td>hm</td> <td>Homing mode</td> </tr> <tr> <td rowspan="2">Speed</td> <td>csv</td> <td>Cyclic synchronous velocity mode</td> </tr> <tr> <td>pv</td> <td>Profile velocity mode</td> </tr> <tr> <td rowspan="2">Torque</td> <td>cst</td> <td>Cyclic synchronous torque mode</td> </tr> <tr> <td>tq</td> <td>Torque profile mode</td> </tr> </tbody> </table>		Modes of operation		position	csp	Cyclic synchronous position mode	PP	Profile position mode	hm	Homing mode	Speed	csv	Cyclic synchronous velocity mode	pv	Profile velocity mode	Torque	cst	Cyclic synchronous torque mode	tq	Torque profile mode
	Modes of operation																				
position	csp	Cyclic synchronous position mode																			
	PP	Profile position mode																			
	hm	Homing mode																			
Speed	csv	Cyclic synchronous velocity mode																			
	pv	Profile velocity mode																			
Torque	cst	Cyclic synchronous torque mode																			
	tq	Torque profile mode																			
Touch Probe	2 channels																				
Synchronization mode	DC (SYNCO event synchronization mode)																				

	SM (SM Event synchronization)
Cyclic time (DC communication period)	500,1000,2000,4000[μs]
Communication object	SDO[Service data object], PDO[Process data object]
Maximum PDO allocation per station	TxPDO: 4 [piece] RxPDO: 4 [piece]
Single station PDO Max bytes	TxPDO: 24[byte] RxPDO: 24[byte]
Mailbox communication interval in PreOP mode	1ms
Mailbox	SDO requests and SDO information

Note:

- (1) See [state machine] for the meanings of SDO and PDO.
- (2) The node length is recommended to be 50m, and CAT5e network cable shall be used above 50m.

1-4. EtherCAT communication connection

The wiring of EtherCAT motion control system is very simple. Thanks to EtherCAT, the star topology of Ethernet can be replaced by a simple linear structure. Taking Xinje DS5C series servo as an example, because EtherCAT does not need hub and switch, XDH, XLH series PLC body and DS5C series servo are equipped with EtherCAT communication network port, so the consumption of cable and bridge is greatly reduced, the workload of connection design and joint calibration is also greatly reduced, which is convenient for saving installation cost. Linear type connection is recommended for EtherCAT bus connection. The wiring mode is as follows:



Note: only LIN2 port in XG2 series PLC supports EtherCAT communication. The two communication network ports of the servo driver follow the principle of "down in and up out", that is, the link2 port of XG2 must be connected with the network port under the LIN1 port of the first servo, and then the network port above the first servo is connected with the network port under the second servo, and so on.

In the process of communication transmission, it will inevitably be affected by the surrounding electromagnetic environment. It is recommended that the user use the industrial CAT5e network cable, which can also be purchased in our company.

2. EtherCAT Communication specification

2-1. EtherCAT frame structure

EtherCAT is an industrial communication protocol based on real-time control of Ethernet. It only expands the IEEE 802.3 Ethernet specification and does not change the basic structure, so it can transmit the data within the standard Ethernet frame.

Because the EtherType of the Ethernet Header is [88A4h], the subsequent Ethernet data is processed as the EtherCAT frame.

The EtherCAT frame is composed of the EtherCAT frame header and more than one EtherCAT sub message, which is further subdivided. Only the EtherCAT frame with type = 1 of the EtherCAT frame header is processed according to ESC.

EtherNet/EtherCAT frame structure

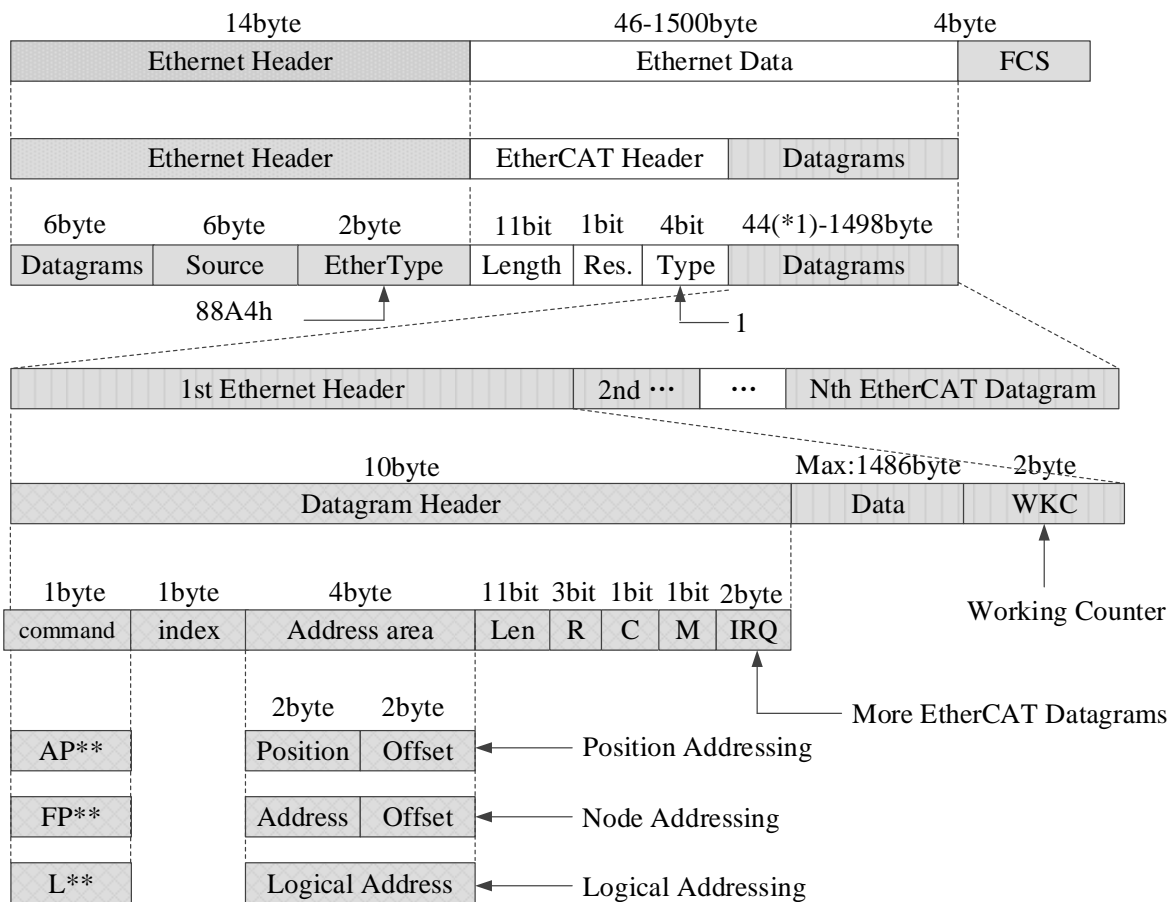

*1: Ethernet frame is shorter than 64 byte, 1-32 byte is added.

(Ethernet Header + Ethernet Data + FCS)

2-2. ESM (EtherCAT State Machine)

The EtherCAT state machine (ESM) is responsible for coordinating the state relationship between the master and slave applications at initialization and runtime.

The state change request is executed by the master station, and the master station puts forward the control request to the application layer service. The latter generates the application layer control event in the slave station, and the slave station responds to the application layer control service through the local application layer state write service after the state change request succeeds or fails. If the status change fails, the slave station keeps the status and puts the error flag.

The figure below shows the state transformation diagram of ESM:

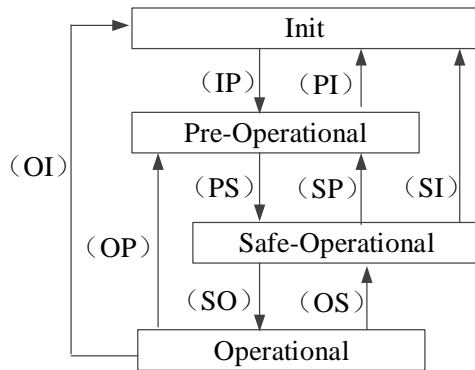

※The (IP) etc. in the state transformation diagram is the abbreviation of state transformation

(IP): Init→Pre-Operational

(PS): Pre-Operational→Safe-Operational

Init: Initialization status;
 Pre-Operational: Pre operation status;
 Safe-Operational: Safe operation status;
 Operational: Operation status;

Slave station status	Actions in various states	Communication action		
		SDO (email) receive and send	PDO send	PDO receive
Init	Communication initialization, SDO, PDO unable to receive and send message	-	-	-
Pre-Operational (PreOP)	Only SDO receiving and sending status	Yes	-	-
Safe-Operational (SafeOP)	Status of SDO receiving and sending only, PDO sending	Yes	Yes	-
Operational (OP)	SDO receiving and sending, PDO receiving and sending all feasible status	Yes	Yes	Yes

Note:

The access from the master station to the ESC register is independent of the above table and is available at any time.

PDO (process data object) is used to transfer periodic communication data.

SDO (service data object) is used to transmit non periodic communication data.

Command or interface operation during ESM state switching may cause abnormal communication error.

2-3. Slave station controller ESC

2-3-1. Principle overview

ESC refers to the EtherCAT slave controller. The communication process is completely processed by ESC, which has four data receiving and transmitting ports, each with a TX and RX. Each port can send and receive Ethernet data frames. The data flow direction in ESC is fixed: port 0 -> port 3 -> port 1 -> port 2 -> port 0 are transmitted in sequence. If ESC detects that a port has no external PHY, it will automatically close the port and automatically forward to the next port through the internal loopback.

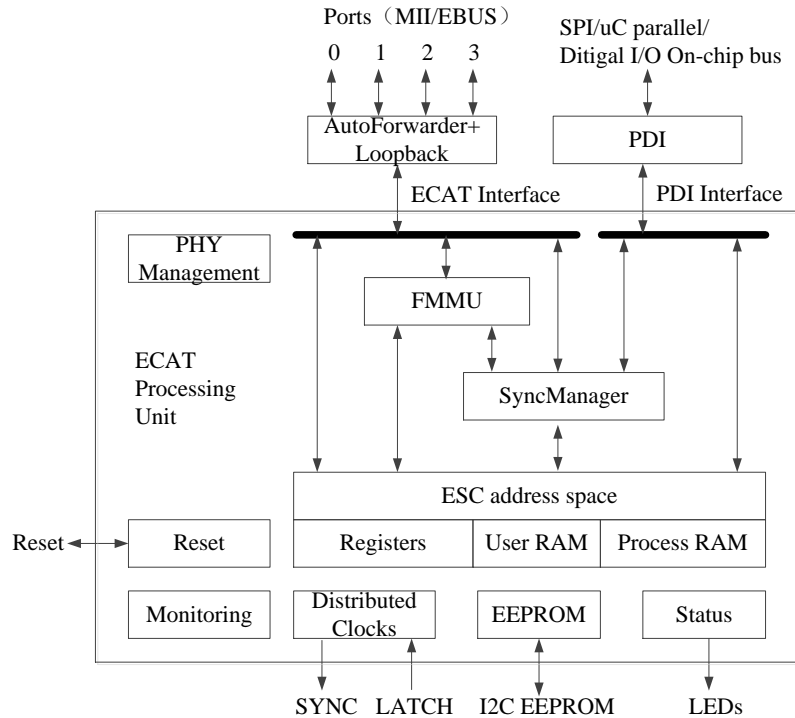

2-3-2. Address space

The DS5C series holds 8kbyte of physical address space.

The first 4kbyte (0000h-0FFFh) is used as register space, and the other 4kbyte (1000h-1FFFFh) is used as process data PDO in RAM field. For details of registers, please refer to the data table of IP (ET1810 / ET1811 / ET1812).

ESC register address	byte	Length (Byte)	Explanation	Initial value*1
ESC Information (slave station controller information)				
0000h		1	Type	04h
0001h		1	Revision	02h
0002h~0003h		2	Build	0040h
0004h		1	FMMUs supported	03h
0005h		1	SyncManagers supported	04h
0006h		1	RAM Size	08h
0007h		1	Port Descriptor	0Fh
0008h~0009h		2	ESC Features supported	0184h
Station Address				
0010h~0011h		2	Configured Station Address	-
0012h~0013h		2	Configured Station Alias	-
...				
Data Link Layer				
...				

ESC register address	byte	Length (Byte)	Explanation	Initial value*1
0100h~0103h		4	ESC DL Control	-
...				
0110h~0111h		2	ESC DL Status	-
Application Layer				
0120h~0121h		2	AL Control	-
0130h~0131h		2	AL Status	-
0134h~0135h		2	AL Status Code	-
...				
PDI				
0140h		1	PDI Control	08h
0141h		1	ESC Configuration	0Ch
0150h		1	PDI Configuration	-
0151h		1	SYNC/LATCH PDI Configuration	66h
0152h~153h		2	Extend PDI Configuration	-
...				
Watchdogs				
0400h~0401h		2	Watchdog Divider	-
0410h~0411h		2	Watchdog Time PDI	-
0420h~0421h		2	Watchdog Time Process Data	-
0440h~0441h		2	Watchdog Status Process Data	-
0442h		1	Watchdog Counter Process Data	-
0443h		1	Watchdog Counter PDI	-
...				
FMMU				
0600h~062Fh		3x16	FMMUs[2:0]	-
+0h~3h		4	Logical Start Address	-
+4h~5h		2	Length	-
+6h		1	Logical Start bit	-
+7h		1	Logical Stop bit	-
+8h~9h		2	Physical Start Address	-
+Ah		1	Physical Start bit	-
+Bh		1	Type	-
+Ch		1	Activate	-
+Dh~Fh		3	Reserved	-
...				
Distributed Clocks (DC) -SYNC Out Unit				
0981h		1	Activation	-
...				
0984h		1	Activation Status	-
098Eh		1	SYNCO Status	-
...				
0990h~0993h		4	Start Time Cyclic Operation/Next SYNCO Pulse	-
...				
09A0h~09A3h		4	SYNCO Cycle Time	-
...				

2-4. SII area (0000h~003Fh)

In the ESC configuration area (EEPROM word address 0000h~0007h), after the power of the drive is started, the configured station alias automatically reads and writes the ESC register according to ESC. When the value of SII EEPROM is reflected in the ESC register, the power supply needs to be started again. In addition, the initial value of IP core (ET1810 / ET1811 / ET1812) is set. Please refer to the data table of IP core (ET1810 / ET1811 / ET1812) for details.

2-5. SDO (Service Data Object)

DS5C series supports SDO (service data object). The data exchange of SDO uses mailbox communication, so the data refresh time of SDO becomes unstable.

The master station reads and writes data in the records in the object dictionary, which can set the object and monitor various states of the slave station. The response to a read-write action to SDO takes time. For objects refreshed with PDO, please do not refresh with SDO, and overwrite with PDO value.

2-5-1. Mailbox frame structure

The frame structure of mailbox/SDO is as follows. Please refer to ETG specification for details (ETG1000-5 and ETG1000-6).

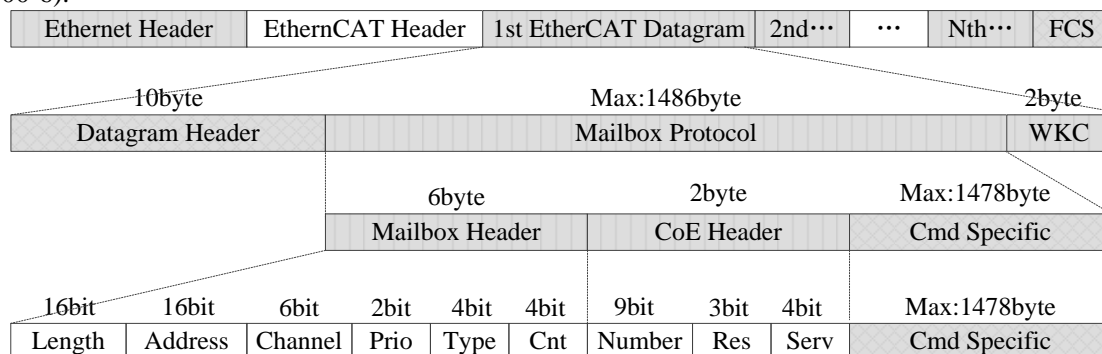

Frame	Data area	Data type	Function
MailBox Header	Length	WORD	Mailbox data length
	Address	WORD	Address of the sender
	Channel	Unsigned6	(Reserved)
	Priority	Unsigned2	Priority
	Type	Unsigned4	Mailbox type 00h: error 01h: (Reserved) 02h: EoE (Not corresponding) 03h: CoE 04h: FoE (Not corresponding) 05h: SoE (Not corresponding) 06h-0Eh: (Reserved) 0Fh: VoE (Not corresponding)
	Cnt	Unsigned3	Mailbox counter
	Reserved	Unsigned1	(Reserved)
CoE Header	Number	Unsigned9	Reserved
	Reserved	Unsigned3	Reserved
	Service	Unsigned4	Message type
Cmd specific	Size Indicator	Unsigned1	Data Set Size use permission
	Transfer Type	Unsigned1	Normal transfer/Expedited transfer
	Data Set Size	Unsigned2	Data size
	Complete Access	Unsigned1	Object access method selection (not

			corresponding)
	Command Specfier	Unsigned3	Upload / download Selection of requirements / responses, etc
	Index	WORD	Object Index
	Subindex	BYTE	Object Subindex
			Object data or abort message, etc

2-5-2. Mailbox overtime

This servo driver performs the following timeout settings in mailbox communication.

Timeout of mailbox request: 100ms

The master station sends a request to the slave station (driver). If the WKC of the transmission data of the request frame is updated, the slave station is considered to receive the request normally. Until WKC is updated, retry again and again. However, if WKC is not updated until this set time, the master station side will time out.

Timeout for mailbox response: 10s

The master receives a response from a request from a slave (driver), which is considered normal if the WKC is updated. Until this set time, if the response of WKC being updated cannot be received, the master station side will time out.

The maximum time required by slave station (driver) response completion.

2-5-3. Alarm information

(1) Error code

Error code returns same value as 603Fh (Error code).

0000H ~ FFFFh is defined according to IEC61800-7-201.

FF00h ~ FFFFh are defined by the manufacturer, as shown below.

Index	Sub-Index	Name/Description	Range	Date Type	Access	PDO	Op-mode
603Fh	00h	Error code	0-65535	U16	ro	TxPDO	All
<p>The present alarm of the servo driver (only the main number). When the alarm does not occur, it will display 0000H. When an alarm occurs, an alarm is displayed. FF**h Alarm (main) number (00h~FFh) (Example) FF03h ... 03h=3d E-030 (overvoltage) FF55h ... 55h=85d E-850(TxPDO configuration abnormal protection), E-851(RxPDO configuration abnormal protection), any of them occurs. As an exception, A000h is displayed in the case of E-817 (syncmanager 2 / 3 setting error).</p>							

(2) Error register

Error register returns same value as 1001h (Error register).

Index	Sub-Index	Name/Description	Range	Date Type	Access	PDO	Op-mode															
1001h	00h	Error register	0-65535	U16	ro	TxPDO	All															
<p>Displays the type of alarm (status) that is occurring to the servo drive. When the alarm does not occur, it will display 0000H. Do not display warnings.</p> <table border="1"> <thead> <tr> <th>Bit</th> <th>Content</th> </tr> </thead> <tbody> <tr> <td>0</td> <td rowspan="4">Not support</td> </tr> <tr> <td>1</td> </tr> <tr> <td>2</td> </tr> <tr> <td>3</td> </tr> <tr> <td>4</td> <td>Alarm occurrence defined by AI status code *1</td> </tr> <tr> <td>5</td> <td>Not support</td> </tr> <tr> <td>6</td> <td>Reserved</td> </tr> <tr> <td>7</td> <td>Alarm occurrence undefined by AI status code *2</td> </tr> </tbody> </table>								Bit	Content	0	Not support	1	2	3	4	Alarm occurrence defined by AI status code *1	5	Not support	6	Reserved	7	Alarm occurrence undefined by AI status code *2
Bit	Content																					
0	Not support																					
1																						
2																						
3																						
4	Alarm occurrence defined by AI status code *1																					
5	Not support																					
6	Reserved																					
7	Alarm occurrence undefined by AI status code *2																					

		<p>*1: The "alarm defined by AL status code" refers to the EtherCAT Communication Association abnormal E-800-7, E-810-7, E-850-7.</p> <p>*2: The "AL status code undefined alarm" refers to the EtherCAT Communication Association abnormal E-880~7 and the exception of EtherCAT Communication Association.</p>
--	--	------------------------------------------------------------------------------------------------------------------------------------------------------------------------------------------------------------------------------------------------------------------------------------------------------------------

2-6. PDO (Process Data Object)

The DS5C series supports PDO (process data object).

The real-time data transfer based on EtherCAT is carried out through the data exchange of PDO (process data object).

PDO has RxPDO transferred from master station to slave station and TxPDO transferred from slave station to master station.

	Sending side	Receiving side
RxPDO	Master station	Slave station
TxPDO	Slave station	Master station

2-6-1. PDO mapping objects

PDO mapping refers to the mapping from object dictionary to application object of PDO.

Tables for DS5C series PDO mapping can use 1600h~1603h mapping objects for RxPDO and 1A00h~1A03h mapping objects for TxPDO.

The maximum number of application objects that a mapping object can map is as follows:

RxPDO: 24 [byte], TxPDO: 24 [byte]

The following is an example of setting a PDO map.

< setting example >

Allocation of application objects 6040h, 6060h, 607Ah, 60B8h to mapping object 1600h (Receive PDO mapping 1: RxPDO_1).

Index	Sub	Object contents	
1600h	00h	04h	
	01h	6040 00 10 h	
	02h	6060 00 08 h	
	03h	607A 00 20 h	
	04h	60B8 00 10 h	
	05h	0000 00 00 h	
	...		
	18h	0000 00 00 h	
6040h	00h	Controlword	U16
6060h	00h	Mode of operation	I8
607Ah	00h	Target Position	I32
60B8h	00h	Touch probe function	U16

2-6-2. PDO distribution objects

In order to exchange PDO data, a table for PDO mapping must be assigned to syncmanager. The relationship between the table used for PDO mapping and syncmanager is described to PDO allocation object. As PDO allocation object, DS5C can use 1C12h for RxPDO (syncmanager2) and 1C13h for TxPDO (syncmanager3).

The maximum number of application objects that a mapping object can map is as follows:

RxPDO: 4 [Table] (1600h~1603h).

RxPDO: 4 [Table] (1A00h~1A03h).

Usually, because one mapping object is enough, there is no need to change by default.

Example of setting PDO assignment object:

Allocation mapping object 1600h to allocation object 1C12h (sync Manager Channel 2).

Index	Sub	Object contents
1C12h	00h	01h
	01h	1600h
	02h	0000h
	03h	0000h
	04h	0000h

Allocation mapping object 1600h to allocation object 1C13h (sync Manager Channel 3).

Index	Sub	Object contents
1C13h	00h	01h
	01h	1A00h
	02h	0000h
	03h	0000h
	04h	0000h

2-7. Communication synchronization mode

DS5C series can select the following synchronization modes.

Synchronization mode	Content	Synchronization method	Feature
DC	SYNC0 Event synchronization	Synchronize the time information of other slave stations based on the time of the first axis	High-precision Compensation treatment shall be carried out at the main station side
SM2	SM2 Event synchronization	Synchronize according to RxPDO receiving time	No transmission delay compensation, poor accuracy Need to keep transmission time on controller side (special hardware, etc.)
FreeRun	Asynchronous	Asynchronous	Simple processing Poor real-time performance

2-7-1. DC (SYNC0 Event synchronization)

DS5C series has 64-bit DC (distributed clock).

The synchronization of EtherCAT communication is based on this DC. According to the DC slave station, synchronization is realized through the system time with the same reference. The local cycle from the slave station starts with the sync0 event. Since the slave processing (servo processing) starts from the sync0 event cycle, it is always synchronized with the sync0 event.

The master station needs to carry out transmission delay compensation (offset compensation) and regular deviation compensation during communication initialization. The following figure shows the process of synchronous completion from the input of control power to the event of sync0 and the processing of slave station (servo processing).

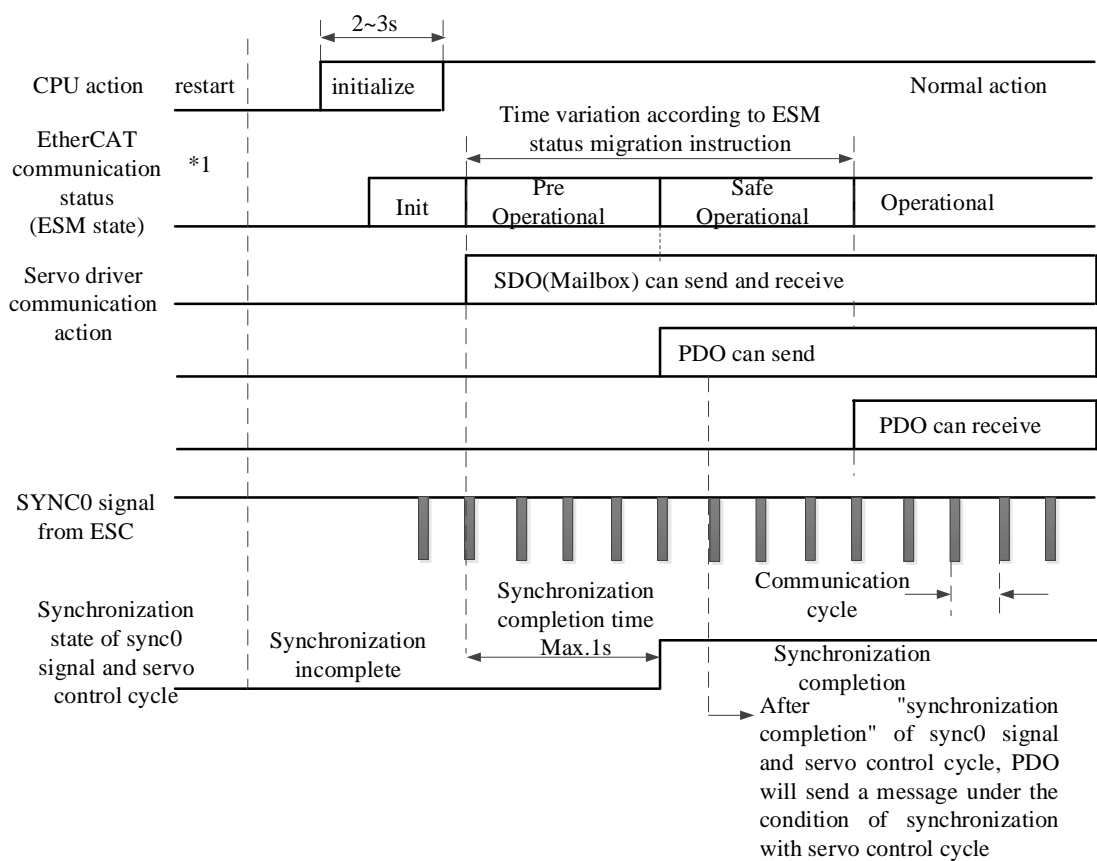

2-7-2. SM2 (SM2 Event synchronization)

The local cycle from the slave station starts with SM2 event.

Since the processing of the slave station starts from the SM2 event cycle, it is always synchronized with SM2 event.

Because SM2 event occurs when PDO receiving is completed, it is necessary to ensure that the upper (Master) side sends the message regularly. If the fluctuation (deviation) of sending time is too large, synchronization cannot be completed, or an alarm occurs.

If this happens, use DC (sync0 event synchronization).

2-8. LED light

The XDH, XLH series has two EtherCAT indicators (LEDs), L/A IN and L/A OUT.

L/A IN and L/A OUT indicator indicate the link status and action status of the physical layer of each port.

The light color is green.

LED state	Content
OFF	Link not established
Flickering	Link established, with data receiving and sending
ON	Link established, no data receiving and sending

3. EtherCAT parameter configuration

3-1. EtherCAT configuration interface

Create a new project. In the picture below, open EtherCAT in the PLC configuration branch of the project area.

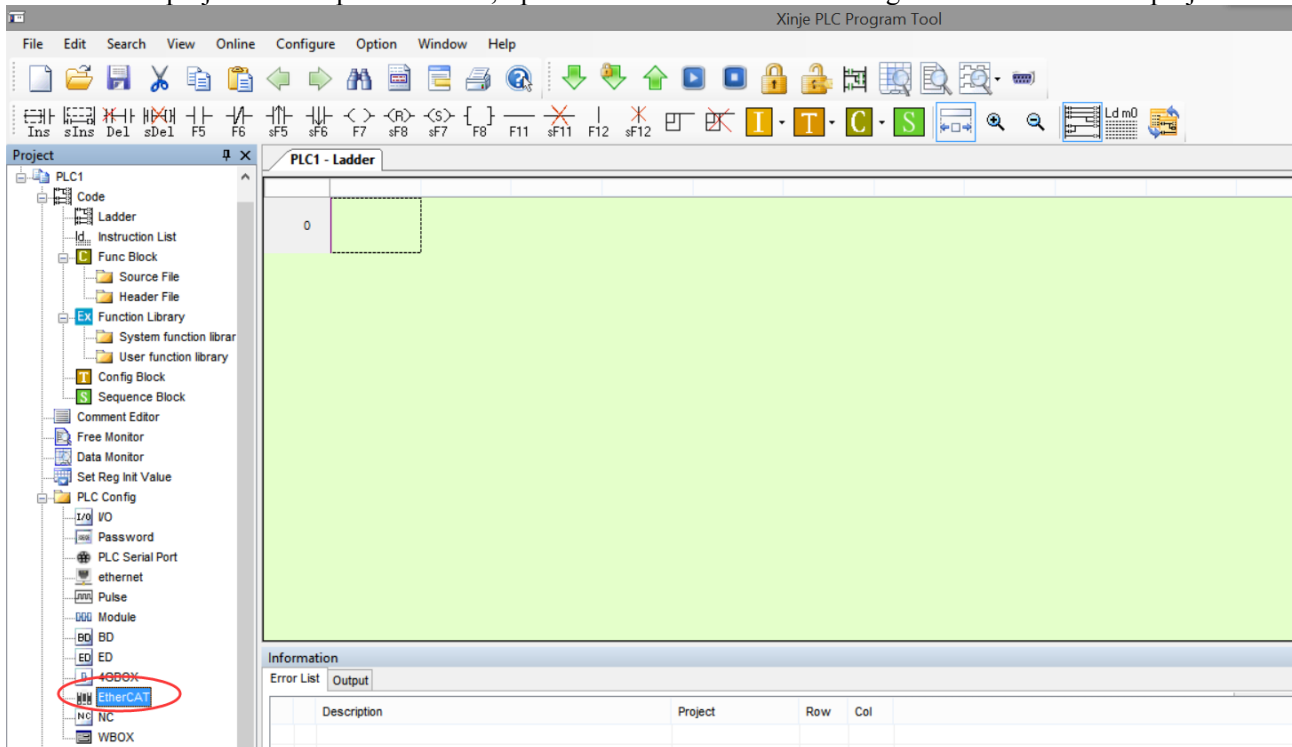

The EtherCAT parameter configuration interface is divided into master station configuration area, slave station display area and slave station configuration area.

- ① Configuration area of master station: set EtherCAT periodic synchronous communication interval, upper computer timeout, ESM state switching of all slaves. (ESM: Ethernet state machine, refer to [state machine])
- ② Display area of slave station: scan or manually add the slave station, and the corresponding configuration information of the slave station selected by the cursor will show on the right side.
- ③ Slave configuration area: corresponds to the configuration information of the currently selected slave station.

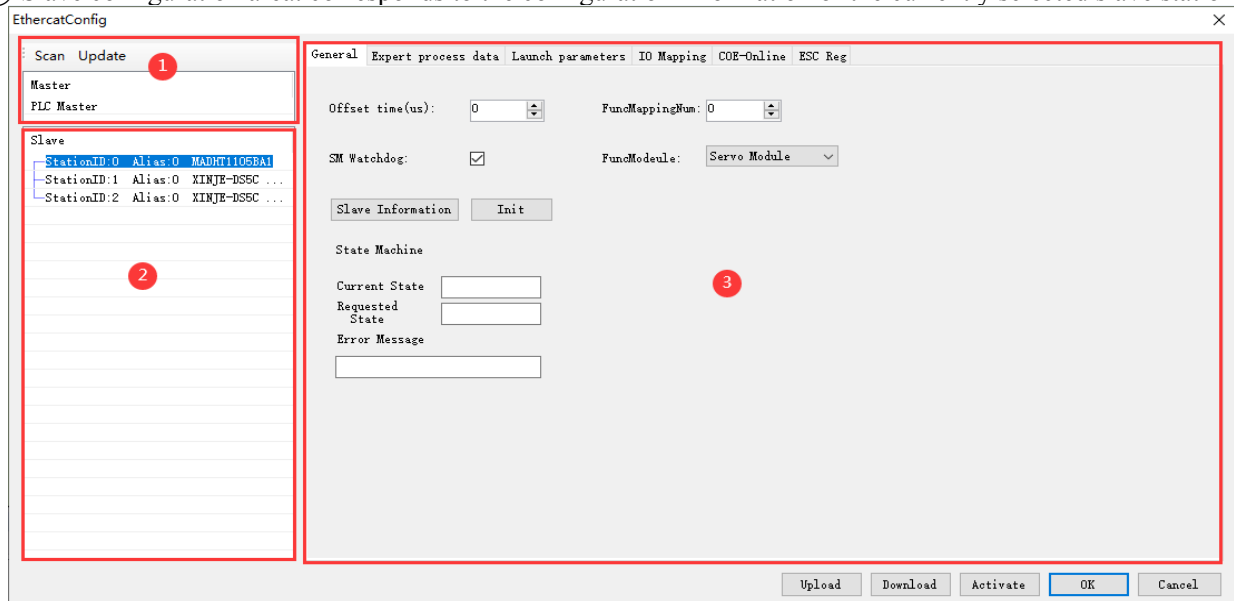

3-2. Master station configuration

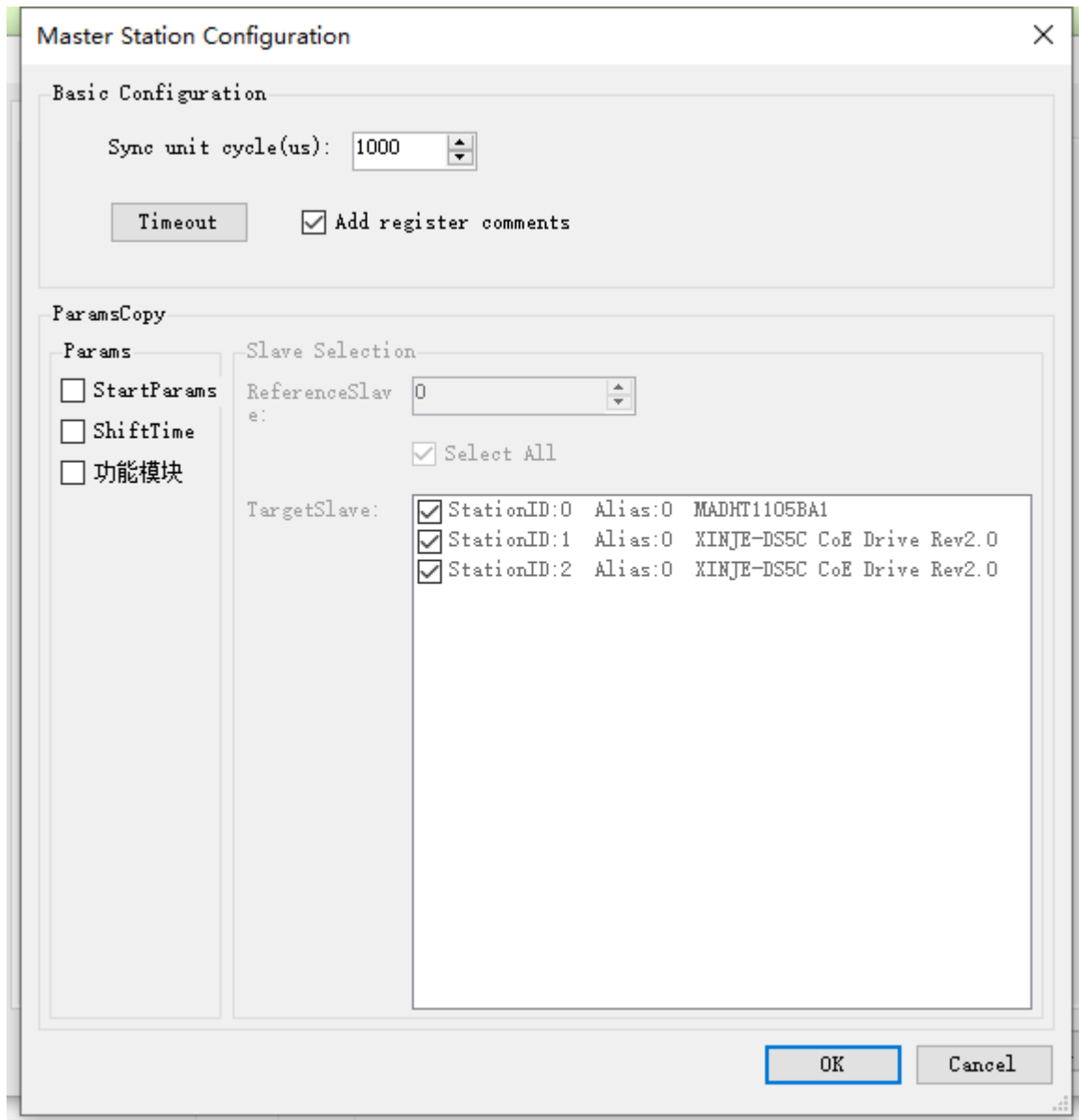

Parameter	Explanation
Synchronization unit cycle	The communication cycle between master station and slave station is 500~10000 (unit: μs) (that is, the sending data time interval between master station and slave station) and SFD2990 is set to the same value. Note: if 16 or less axis slave station is connected, it can be set to 500; if 32 or less axis slave station is connected, it can be set to 1000.
Timeout	Communication timeout setting of upper computer and related functions of EtherCAT.
Parameter copy	Tick the parameters to be copied (the contents include startup parameters and offset time, see 2-5 and 2-7 for the meaning), and copy them to the target slave station based on the parameters of [reference slave station] (the number here refers to station ID). The target slave station can be selected in full or selected in part.

3-3. Slave station list

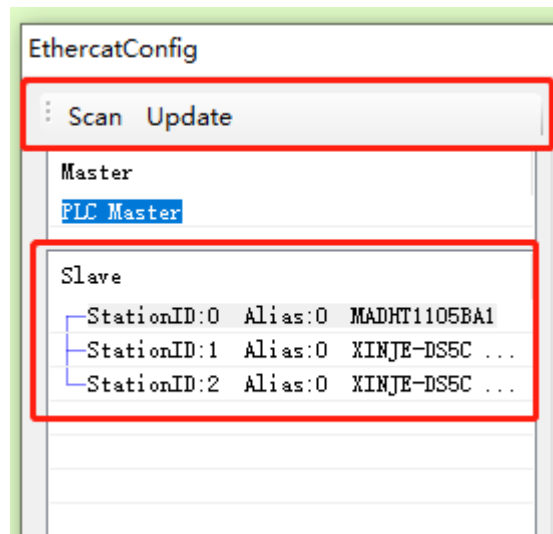

Parameter	Explanation
Scan	Scan to obtain the topology of the current slave, and find out whether there is a matching slave XML file locally. If not, try to read the EEPROM and object dictionary of the slave to generate temporary XML. There is no need to stop the PLC. Note: the scanned slave station distinguishes the first station by station ID, station ID: 0 represents the first station, and so on.
Add	Add the XML file of the slave station (the corresponding XML file is required, which is stored in the EtherCAT / folder under the installation directory of Xinje PLC programming software). The default configuration of the slave station is related to XML.
Copy	Copy the selected configuration item and add it to the last.
Delete	Delete the selected configuration item.
Up	Move up the selected configuration item.
Down	Move down the selected configuration item.
Update	Update the slave station list.

Note: the order in the slave station list must be consistent with the actual connection order. If not, after clicking [activate] (meaning of activation 3-4 [activate]), the upper computer system will give the following prompt, and the equipment will not work normally.

3-4. Slave station configuration

General Expert process data Launch parameters IO Mapping COE-Online ESC Reg

Offset time(us): 0 FuncMappingNum: 0

SM Watchdog: FuncModule: Servo Module

Slave Information Init

State Machine

Current State

Requested State

Error Message

Upload Download Activate OK Cancel

Parameter	Explanation
Download	Download the configuration parameters to the flash of PLC without stopping PLC. Note: (1) The downloaded configuration is stored in the flash of PLC. Click activate to take effect. (2) The download here is only for PLC debugging (also can be saved in case of power failure). Please tick the EtherCAT parameter option when downloading the PLC project, otherwise there is no Ethercat configuration data when uploading the PLC project.
Upload	The configuration information in PLC is uploaded to the upper computer without stopping PLC.
Activate	The configuration data in the current PLC will take effect immediately. It will switch from any state of the slave station to Init, and then to OP state (Init → PreOP → Safeop → OP). The effect is equivalent to stopping the PLC and then running the PLC. It is not necessary to stop PLC (for the meaning of slave station state, see the state machine in the general interface).
Ok	Exit the interface and save the currently modified data. Note: only the data will be saved, and the activation parameters will not take effect without downloading.
Cancel	Exit the interface without saving, which is equivalent to pressing the X button in the upper right corner.

3-5. General

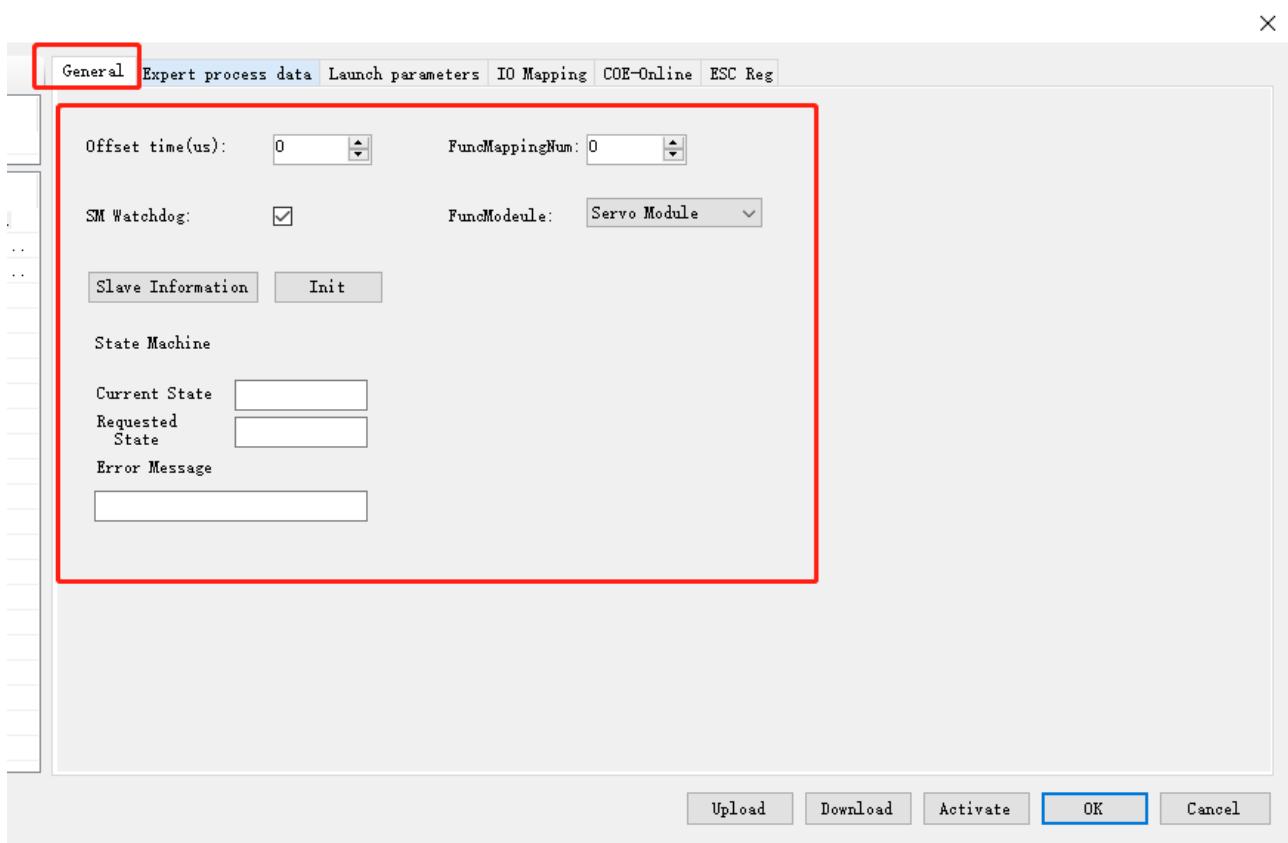

Parameter	Explanation
Offset time	Its specific meaning is shown in the communication sequence diagram. The shift time in the diagram represents the experienced offset time.
SM watchdog	If the watchdog is selected, it will force set 0x420 (watchdog timing time) of ESC register to 1000. Note: the function of the watchdog is to reset the system when the program dead or crashes.
Initialization	Restore all the configuration of the selected slave station to the default configuration, which needs to be downloaded again to take effect.
Slave information	It is used to download EEPROM during servo production and updating, and its download function is not open to users by default.
PreOP, OP, Init, SafeOP	Switch the slave station to specified state.
Current state	The current status of the slave. The current slave status can be monitored through SD [8021 + 20 * I]. * 1
Requested state	Status of the slave request. Mode switching control requirements can be monitored through SD [8029 + 20 * I]. * 1
Error message	Error is reported when slave station state switching error. You can confirm the status switching error message through SD [8028 + 20 * I]. * 1
Function module	It is used to map the EtherCAT slave station to the specified function module. For example, if the slave station 0 is the servo, the module selection is set as the servo module. At this time, the predefined functions of the motion control module will be associated with some necessary PDO objects. If you want to customize the operation, you can select user define. At this time, PDO data can be modified arbitrarily by the value of IO mapping. (note that IO module is not open temporarily, and its effect is equivalent to user define)
Function mapping number	Used to bind the EtherCAT slave to the specified module function. For example, there are two slave stations, namely, station 0 and station 1. You can set the [function mapping number] of station 0 to 1, and station 1 to 0. At this time, the slave station 1 is controlled by station 0 in the motion control module, while the slave station 0 is controlled by station 1 in the motion control module.

*1: refer to EtherCAT motion control manual appendix 1 for details.

Slave station status	Actions in various states	Communication action		
		SDO (mail) receive and send	PDO send	PDO receive
Init	Communication initialization, SDO, PDO unable to receive and send messages	-	-	-
Pre-Operational (PreOP)	the status of only SDO sends and receives message	Yes	-	-
Safe-Operational (SafeOP)	the status of only SDO sends and receives, PDO sends message	Yes	Yes	-
Operational (OP)	all feasible status of SDO receiving and sending, PDO receiving and sending	Yes	Yes	Yes

Note: the access from the master station to the ESC register is independent of the above table and is available at any time.

PDO (process data object) is used to transfer periodic communication data.

SDO (service data object) is used to transmit non periodic communication data.

Command or interface operation during ESM state switching may cause abnormal communication error.

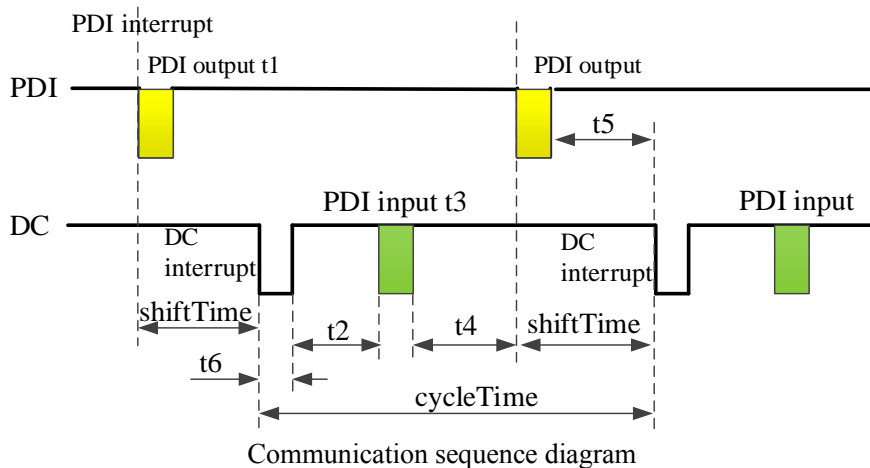

Related concepts and key time points are as follows:

PDI	Process data interface
DC	Distributed clock
ESC	EtherCAT slave station controller
MCU	Microprocessor
PDI interruption	This interrupt is triggered when the master sends data to the slave
PDI falling edge	EOF is the completion of acquiring data frame from the slave station ESC
PDI rising edge	The slave MCU has obtained the current PDO data from ESC
PDI output	Copy PDO data from ESC to MCU and wait for MCU to process, which takes time t1
DC interrupt	Timing interrupt with reference clock as time reference, whose cycle is cycleTime (i.e. synchronization unit cycle), is responsible for triggering data processing of slave station (the same as Xnet data processing)
DC rising edge	Trigger data processing of each slave station
PDI input	Copy PDO data from MCU to ESC and wait for master station to read next cycle, which takes time t3

3-6. Expert process data

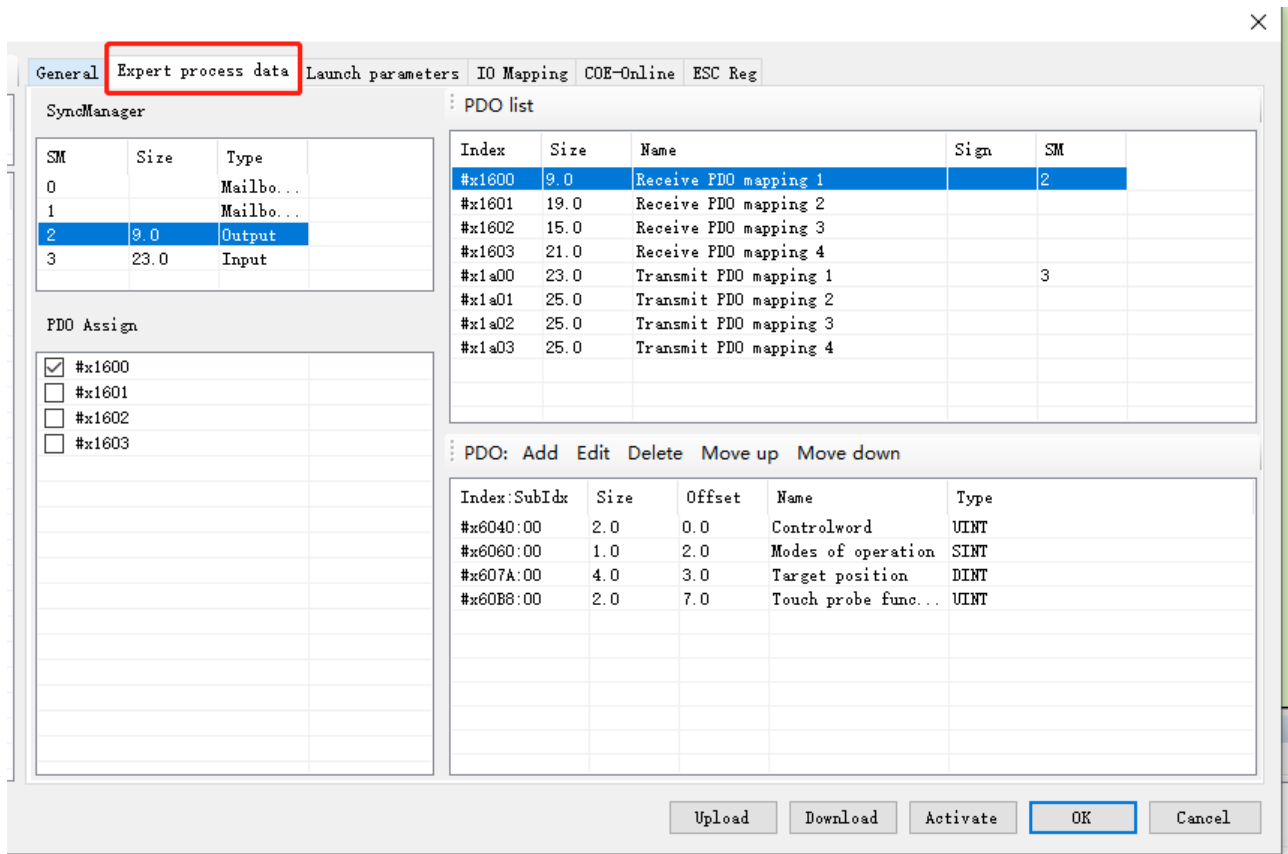

Parameter	Explanation
Synchronization manager	SM0, 1: for the interaction of mailbox data (SDO); SM2, 3 for the interaction of PDO data (its type input and output are relative to the master station). Note: (1) PDO (process data object) is used to transfer periodic communication data. (2) SDO (service data object) is used to transmit non periodic communication data.
PDO distribution	Specifies the PDO of the corresponding SM, up to 4 can be selected, and the size does not exceed 24 bytes. (the larger the PDO data is, the longer the transmission time is, and it may not be completed in the synchronization unit cycle. Therefore, it is impossible to guarantee the stability of data transmission when there are many slave stations and each slave station has a large PDO data.)
PDO list	Some PDO maps predefined in the servo XML, RxPDO represents PDO transmitted from the master station to the slave station, 1600h ~ 1603h can be used, TxPDO represents PDO transmitted from the slave station to the master station, and 1A00h ~ 1A03h can be used.
PDO content	The PDO objects to be mapped are specified from the object dictionary, and the objects are periodically exchanged through PDO. (RxPDO must have 6040h, 6060h, 607Ah, TxPDO must have 6041h, 6061h, 6064h, 606Ch)

3-7. Launch parameter

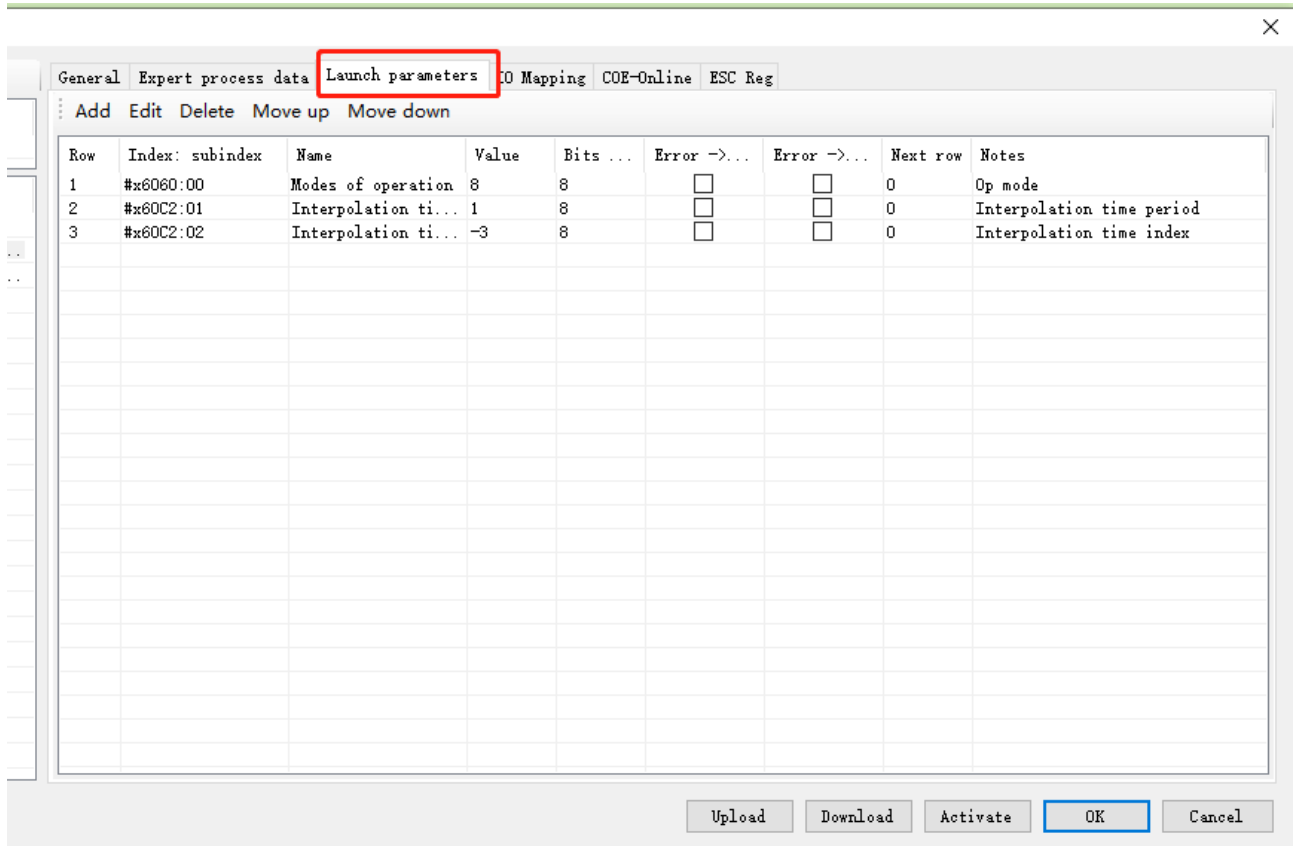

There are three default configurations in the startup parameters, of which 6060h is the operation mode of the slave station, with the default value of 8 (CSP mode); 60C2-1 and 60C2-2 are the synchronization unit cycle, 60C2-1 is the value of the synchronization unit cycle, and 60C2-2 is the unit of the synchronization unit cycle, for example, the default synchronization unit cycle is 100×10^{-5} s, that is, 1000us. (this parameter will change automatically with the synchronization period configured by the master station, and does not need to be modified manually.).

You can configure startup parameters and their execution order through [add], [edit], [delete], [move up] and [move down].

Note: the execution order is from top to bottom. You can write different values to the same parameter, indicating that the parameters are set in the order from top to bottom.

[Error -> Exit]: indicates that if there is an error in configuring this parameter, all the following configurations will be skipped.

[Click error -> jump] and [next line] to specify to jump to the specified line to continue configuration when an error occurs.

3-8. IO mapping

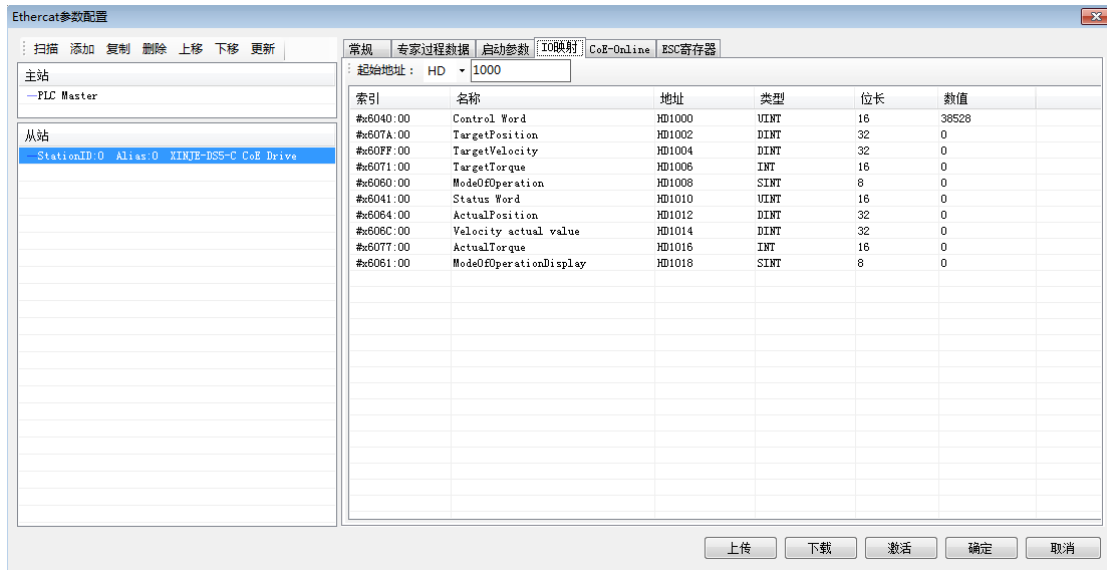

The allocated RxPDO and TxPDO will be mapped to the register starting from the [start address], and the register types can be HD and D. Modifying the [start address] will automatically arrange the addresses according to the parameter order. If there is a duplicate address with other stations, an error will be reported and the address will be automatically arranged to a non duplicate address.

Parameter types in IO mapping can be divided into read-only (RO) and read-write (RW). Parameter types can be seen in CoE-Online. In particular, 6040h (RW) is only writable in homing mode (6060h is 6), and 607A (RW) is not writable in any mode.

If a new PDO is added to the IO mapping, it will be automatically sorted in the order of RxPDO first and TxPDO later. The corresponding register addresses will also be allocated in order. If the allocated address conflicts with other set slave addresses, the unused addresses will be automatically selected.

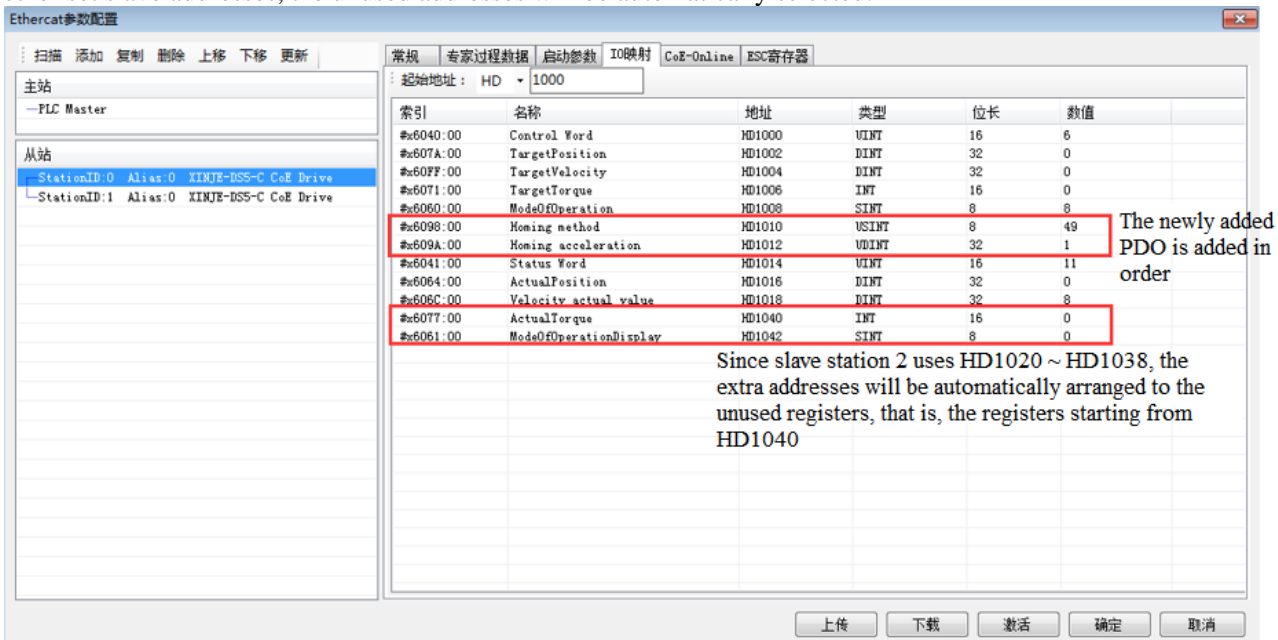

Note: The address automatically assigned due to address conflict starts from HD1000. The unused addresses are shown as below:

常规 专家过程数据 启动参数 I/O映射 CoE-Online ESC寄存器

起始地址: HD 2000

索引	名称	地址	类型	位长	数值
#6040:00	Control Word	HD2000	UINT	16	16960
#607A:00	TargetPosition	HD2002	DINT	32	0
#607F:00	TargetVelocity	HD2004	DINT	32	0
#6071:00	TargetTorque	HD2006	INT	16	0
#6060:00	ModeOfOperation	HD2008	SINT	8	0
#6098:00	Homing method	HD2010	USINT	8	0
#609A:00	Homing acceleration	HD2012	UINT	32	0
#6041:00	Status Word	HD2014	UINT	16	0
#6064:00	ActualPosition	HD2016	DINT	32	0
#606C:00	Velocity actual value	HD2018	DINT	32	0
#6077:00	ActualTorque	HD1000	INT	16	8
#6061:00	ModeOfOperationDisplay	HD1002	SINT	8	0

slave station 2 uses the address HD2020~HD2040,
the auto assigned addresses start with HD1000

上传 下载 激活 确定 取消

3-9. COE-Online interface

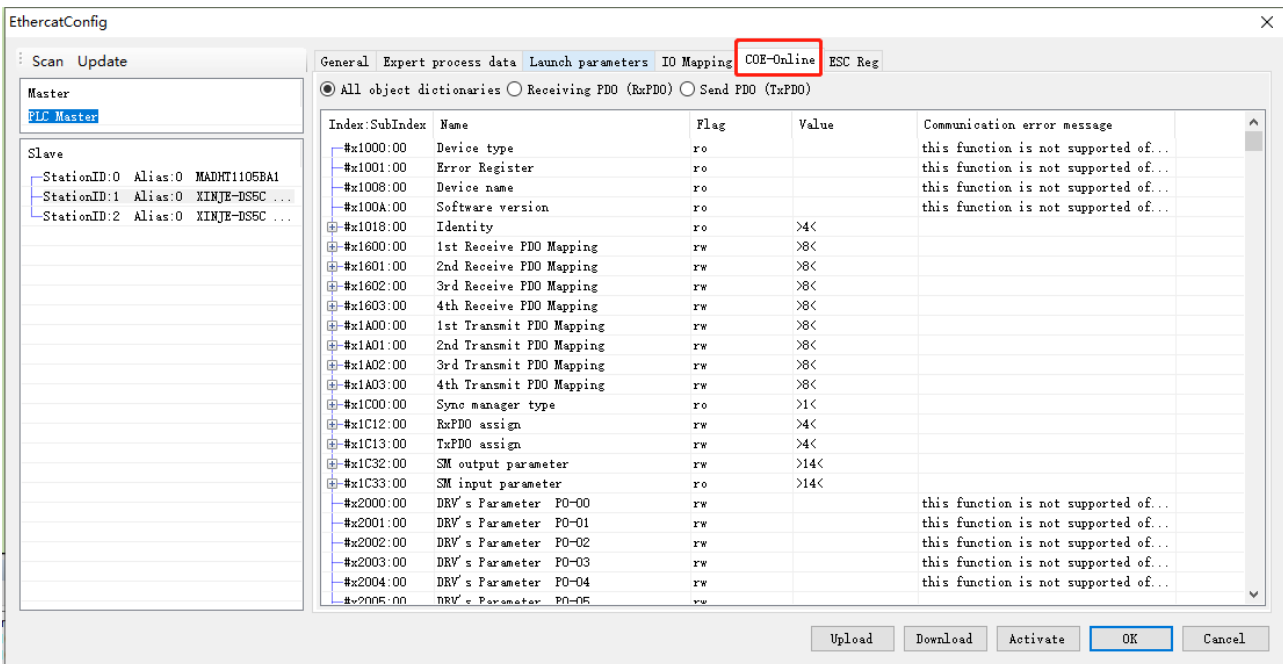

COE-Online has the function of reading and writing all object Dictionaries Online. When the interface is opened, the data will be updated all the time. Select the slave of COE online from the list of slave stations on the left. Double click the RW type object dictionary to make online modification.

COE-Online contains object types:

Object type	Explanation
0x1000	Device type
0x1001	Servo driver alarm type (status)
0x1008	Manufacturer equipment name
0x1009	Manufacturer hardware version
0x100A	Manufacturer software version
0x1018	Device information
0x1C00	Synchronous management communication type (SyncManager)
0x1C12, 0x1C13	Process data object (PDO) mapping
1600h~1603h, 1A00h~1A03h	PDO mapping object
0x1C32, 0x1C33	Synchronous management SM2/3
0x6000-0x6fff	Cia402 Profile COE object
0x2000-0x5fff	Xinje customized object

3-10. ESC register

ESC refers to EtherCAT slave controller, and ESC register interface is the interface for monitoring and modifying slave registers.

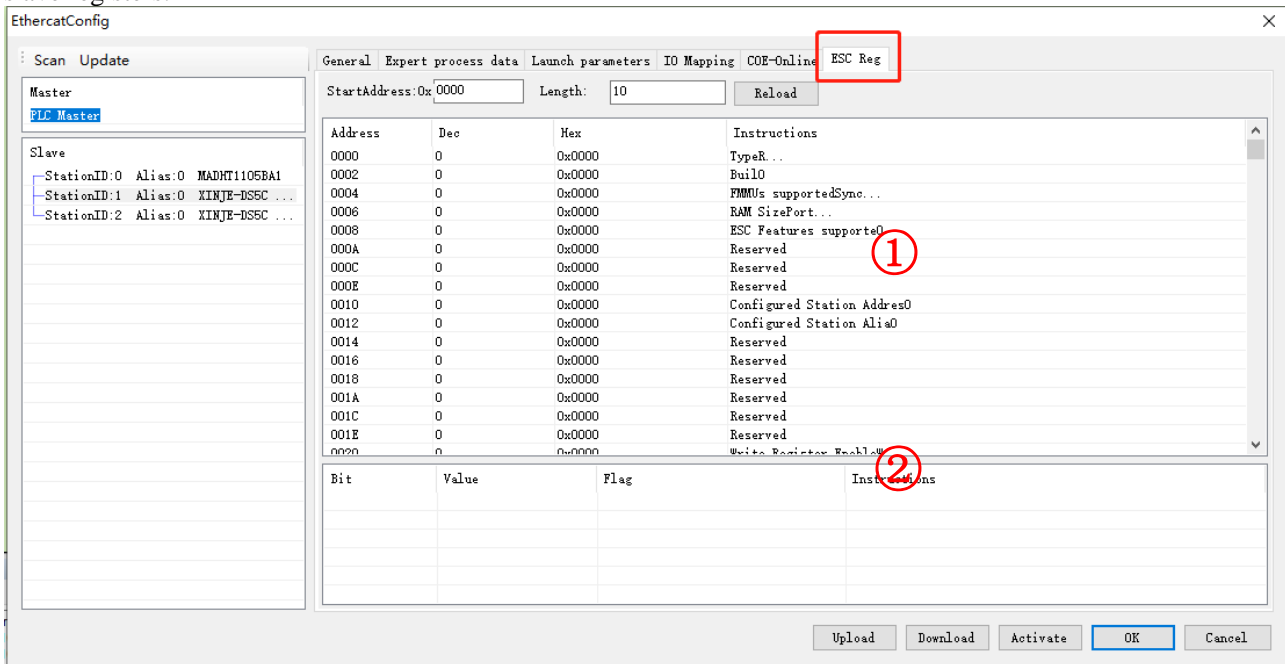

Parameter	Explanation
Start address	Set the starting value (hexadecimal) of the register to be monitored.
Length	Number of registers to be monitored, decimal.
Reload	Click to display the value. The current value is displayed only once.
Interface 1	Only the value of each register is displayed and cannot be modified.
Interface 2	The meaning of each bit of the register determines the read/write permission according to the flag. R-readable, w-writable, w (CLR) - write as clear as 0.

Note: the value modification of some registers will disconnect the communication. If there is no special case, it is not necessary to modify.

4. Object dictionary (CoE-Online)

4-1. Object dictionary area assignment

All objects are configured in the object dictionary of each group through the 16-bit index configuration address represented by 4-bit hex.

The object dictionary of CoE (CANopen over EtherCAT) specified by CiA402 and the object dictionary of DS5C series are as follows:

Object dictionary according to CiA402		Object dictionary of DS5C series	
Index	Content	Index	Content
0000h~0FFFh	data type area	0000h~0FFFh	data type area
1000h~1FFFh	COE communication area	1000h~1FFFh	COE communication area
2000h~5FFFh	User-defined area	2000h~2FFFh	servo parameter area
		3000h~3FFFh	Reserved
		4000h~4FFFh	Reserved
		5000h~5FFFh	Reserved
6000h~9FFFh	Profile area	6000h~6FFFh	Driver Profile area
		7000h~9FFFh	Reserved
A000h~FFFFh	Reserved	A000h~FFFFh	Reserved

4-2. COE communication area (0x1000-0x1FFF)

4-2-1. Object list

(1) Device information object

Index	Sub-Index	Name
1000h	00h	Device type
1001h	00h	Error register
1008h	00h	Manufacturer device name
1009h	00h	Manufacturer hardware version
100Ah	00h	Manufacturer software version
1018h	-	Diagnosis history
	00h	Number of entries
	01h	Vendor ID
	02h	Product code
	03h	Revision number
	04h	Serial number

(2) RxPDO object mapping

Index	Sub-Index	Name
1600h	-	Receive PDO mapping 1
	00h	Number of entries
	01h	1st receive PDO mapped
	02h	2nd receive PDO mapped
	03h	3rd receive PDO mapped
	04h	4th receive PDO mapped
	05h	5th receive PDO mapped

	18h	24th receive PDO mapped
1601h	-	Receive PDO mapping 2
	00h	Number of entries

Index	Sub-Index	Name
	01h	1st receive PDO mapped
	02h	2nd receive PDO mapped
	03h	3rd receive PDO mapped
	04h	4th receive PDO mapped
	05h	5th receive PDO mapped

	18h	24th receive PDO mapped
1602h	-	Receive PDO mapping 3
	00h	Number of entries
	01h	1st receive PDO mapped
	02h	2nd receive PDO mapped
	03h	3rd receive PDO mapped
	04h	4th receive PDO mapped
	05h	5th receive PDO mapped

18h	24th receive PDO mapped	
1603h	-	Receive PDO mapping 4
	00h	Number of entries
	01h	1st receive PDO mapped
	02h	2nd receive PDO mapped
	03h	3rd receive PDO mapped
	04h	4th receive PDO mapped
	05h	5th receive PDO mapped

18h	24th receive PDO mapped	

(3) TxPDO object mapping

Index	Sub-Index	Name
1A00h	-	Transmit PDO mapping 1
	00h	Number of entries
	01h	1st transmit PDO mapped
	02h	2nd transmit PDO mapped
	03h	3rd transmit PDO mapped
	04h	4th transmit PDO mapped
	05h	5th transmit PDO mapped

18h	24th transmit PDO mapped	
1A01h	-	Transmit PDO mapping 2
	00h	Number of entries
	01h	1st transmit PDO mapped
	02h	2nd transmit PDO mapped
	03h	3rd transmit PDO mapped
	04h	4th transmit PDO mapped
	05h	5th transmit PDO mapped

18h	24th transmit PDO mapped	
1A02h	-	Transmit PDO mapping 3
	00h	Number of entries
	01h	1st transmit PDO mapped
	02h	2nd transmit PDO mapped
	03h	3rd transmit PDO mapped
	04h	4th transmit PDO mapped
	05h	5th transmit PDO mapped

18h	24th transmit PDO mapped	

Index	Sub-Index	Name
1A03h	-	Transmit PDO mapping 4
	00h	Number of entries
	01h	1st transmit PDO mapped
	02h	2nd transmit PDO mapped
	03h	3rd transmit PDO mapped
	04h	4th transmit PDO mapped
	05h	5th transmit PDO mapped

	18h	24th transmit PDO mapped

(4) PDO object distribution

Index	Sub-Index	Name
1C12h	-	Sync manager channel 2
	00h	Number of assigned PDOs
	01h	Assigned RxPDO 1
	02h	Assigned RxPDO 2
	03h	Assigned RxPDO 3
	04h	Assigned RxPDO 4
1C13h	-	Sync manager channel 3
	00h	Number of assigned PDOs
	01h	Assigned TxPDO 1
	02h	Assigned TxPDO 2
	03h	Assigned TxPDO 3
	04h	Assigned TxPDO 4

(5) PDO synchronous management channel

Index	Sub-Index	Name
1C32h	-	Sync manager 2 synchronization
	00h	Number of sub-objects
	01h	Sync mode
	02h	Cycle time
	03h	Shift time
	04h	Sync modes supported
	05h	Minimum cycle time
	06h	Calc and copy time
	08h	Command
	09h	Delay time
	0Ah	Sync0 cycle time
	0Bh	Cycle time too small
	0Ch	SM-event missed
	0Dh	Shift time too short
	0Eh	RxPDO toggle failed
	20h	Sync error
1C32h	-	Sync manager 2 synchronization
	00h	Number of sub-objects
	01h	Sync mode
	02h	Cycle time
	03h	Shift time
	04h	Sync modes supported
	05h	Minimum cycle time
	06h	Calc and copy time
	08h	Command
	09h	Delay time
	0Ah	Sync0 cycle time
	0Bh	Cycle time too small
0Ch	SM-event missed	

Index	Sub-Idx	Name
	0Dh	Shift time too short
	0Eh	RxPDO toggle failed
	20h	Sync error

4-2-2. Device information

This section describes the equipment information.

Index	Sub-Index	Name/Description	Range	Date Type	Access	PDO	Op-mode															
1000h	00h	Divece type	0~4294967295	U32	ro	NO	All															
		Indicates the device type. In case of servo driver, the value is fixed to 04020192h.																				
1001h	00h	Error register	0~65535	U16	ro	TxPDO	All															
		Displays the type of alarm (status) that is occurring to the servo driver. When the alarm does not occur, it will display 0000H. Do not display warnings.																				
		<table border="1"> <thead> <tr> <th>Bit</th> <th>Content</th> </tr> </thead> <tbody> <tr> <td>0</td> <td rowspan="3">Not support</td> </tr> <tr> <td>1</td> </tr> <tr> <td>2</td> </tr> <tr> <td>3</td> <td rowspan="2">Alarm occurrence defined by AL status code *1</td> </tr> <tr> <td>4</td> </tr> <tr> <td>5</td> <td>Not support</td> </tr> <tr> <td>6</td> <td>Reserved</td> </tr> <tr> <td>7</td> <td>Alarm occurrence undefined by AL status code *2</td> </tr> </tbody> </table>						Bit	Content	0	Not support	1	2	3	Alarm occurrence defined by AL status code *1	4	5	Not support	6	Reserved	7	Alarm occurrence undefined by AL status code *2
Bit	Content																					
0	Not support																					
1																						
2																						
3	Alarm occurrence defined by AL status code *1																					
4																						
5	Not support																					
6	Reserved																					
7	Alarm occurrence undefined by AL status code *2																					
		*1) The "alarm defined by AL status code" refers to the EtherCAT Communication Association Error E-800~7, E-810~7, E-850~7.																				
		*2) The "AL status code undefined alarm" refers to the EtherCAT Communication Association Error E-880~7 and the error except EtherCAT Communication Association.																				
1008h	00h	Manufacturer device name	-	-	ro	TxPDO	All															
		Device name.																				
1009h	00h	Manufacturer hardware version	-	-	ro	TxPDO	All															
		Hardware version.																				

Index	Sub-Index	Name/Description	Range	DateType	Access	PDO	Op-mode
1018h	00h	Number of entries	0~255	U8	ro	TxPDO	All
		Sub-index number for this object. The value is fixed to 04H.					
	01h	Vendor ID	0~4294967295	U32	ro	TxPDO	All
		Manufacturer ID of EtherCAT. The value is fixed to 00000 556h.					
	02h	Product code	0~4294967295	U32	ro	TxPDO	All
		Product code. The value is 10305070h.					
	03h	Revision umber	0~4294967295	U32	ro	TxPDO	All
		Product version number. The value is 02040608h.					
	04h	Divece type	0~4294967295	U32	ro	TxPDO	All
		Product serial number. The value is 00000000h.					

4-2-3. Sync manager communication type (1C00h)

The action mode assigned to each syncmanager is set by 1C00h object.
The value is fixed for the servo driver.

Index	Sub-Index	Name/Description	Range	DateType	Access	PDO	Op-mode
1C00h	00h	Number of used sync manager channels	0~255	U8	ro	TxPDO	All
		The number of child indexes for this object. The value is fixed to 04H.					
	01h	Communication type sync manager 0	0~4	U8	ro	TxPDO	All
		Set the purpose of sync Manager 0. 0: unused. 1: Mailbox receive (master station→slave station) 2: Mailbox send (slave station→master station) 3: RxPDO (master station→slave station) 4: TxPDO (slave station→master station) Because sync manager0 uses mailbox to receive messages, the value is fixed to 1.					
	02h	Communication type sync manager 1	0~4	U8	ro	TxPDO	All
		Set the purpose of sync Manager 1. 0: unused. 1: Mailbox receive (master station→slave station) 2: Mailbox send (slave station→master station) 3: RxPDO (master station→slave station) 4: TxPDO (slave station→master station) Because sync manager1 uses mailbox to send messages, the value is fixed to 2.					
	03h	Communication type sync manager 2	0~4	U8	ro	TxPDO	All
		Set the purpose of sync Manager 2. 0: unused. 1: Mailbox receive (master station→slave station) 2: Mailbox send (slave station→master station) 3: RxPDO (master station→slave station) 4: TxPDO (slave station→master station) Because sync manager2 uses process data output (RxPDO), the value is fixed to 3.					
	04h	Communication type sync manager 3	0~4	U8	ro	TxPDO	All
		Set the purpose of sync Manager 3. 0: unused. 1: Mailbox receive (master station→slave station) 2: Mailbox send (slave station→master station) 3: RxPDO (master station→slave station) 4: TxPDO (slave station→master station) Because sync manager3 uses process data output (RxPDO), the value is fixed to 4.					

4-2-4. PDO mapping

1. PDO distribution object (1C12h~1C13h)

The type of PDO mapping table allocated by syncmanager is set by 1C12h to 1C13h objects.

Index	Sub-Index	Name/Description	Range	Date Type	Access	PDO	Op-mode
1C12h	00h	Number of assigned PDOs	0~4	U8	rw	NO	All
		The number of subindexes for this object.					
	01h	Assigned RxPDO 1	1600h~1603h	U16	rw	NO	All
		Specify the RxPDO mapping object.					
	02h	Assigned RxPDO 2	1600h~1603h	U16	rw	NO	All
		Specify the RxPDO mapping object.					
	03h	Assigned RxPDO 3	1600h~1603h	U16	rw	NO	All
		Specify the RxPDO mapping object.					
	04h	Assigned RxPDO 4	1600~1603	U16	rw	NO	All
		Specify the RxPDO mapping object.					
1C13h	00h	Number of assigned PDOs	0~4	U8	rw	NO	All
		The number of subindexes for this object. The value is fixed to 04h.					
	01h	Assigned TxPDO 1	1A00h~1A03h	U16	rw	NO	All
		Specify the TxPDO mapping object.					
	02h	Assigned TxPDO 2	1A00h~1A03h	U16	rw	NO	All
		Specify the TxPDO mapping object.					
	03h	Assigned TxPDO 3	1A00h~1A03h	U16	rw	NO	All
		Specify the TxPDO mapping object.					
	04h	Assigned TxPDO 4	1A00h~1A03h	U16	rw	NO	All
		Specify the TxPDO mapping object.					

Subindex01h-04h of 1C12h and 1C13h can only be changed when the ESM state is PreOP and subindex00h = 0. In addition, the status is the return port code (06010003h).

After the setting is changed, set the subindex number of subindex00h, and reflect PDO distribution object setting by converting ESM state to SafeOP.

2. PDO mapping object (1600h~1603h, 1A00h~1A03h)

As a table for PDO mapping objects, objects of 1600h~1603h for RxPDO and 1A00h~1A03h for TxPDO can be used. After subindex 01h, it represents the information of the mapped application layer object.

Index	Sub-Index	Name/Description	Range	DateType	Access	PDO	Op-mode						
1600h	00h	Number of entries	0~4294967295	U8	rw	NO	All						
		Subindex number of the object.											
	01h	1st receive PDO mapped	0~4294967295	U32	rw	NO	All						
		Set the first mapping object.											
		<table border="1" style="width: 100%; border-collapse: collapse;"> <tr> <td style="width: 10%;">bit</td> <td style="width: 20%;">31 ... 16</td> <td style="width: 20%;">15 ... 8</td> <td style="width: 20%;">7 ... 0</td> </tr> <tr> <td></td> <td>Index number</td> <td>Sub-index number</td> <td>Bit length</td> </tr> </table>	bit	31 ... 16	15 ... 8	7 ... 0		Index number	Sub-index number	Bit length			
	bit	31 ... 16	15 ... 8	7 ... 0									
		Index number	Sub-index number	Bit length									
	02h	2nd receive PDO mapped	0~4294967295	U32	rw	NO	All						
		Setting method is same to Subindex01h.											
	03h	3rd receive PDO mapped	0~4294967295	U32	rw	NO	All						
		Setting method is same to Subindex01h.											
	04h	4th receive PDO mapped	0~4294967295	U32	rw	NO	All						
		Setting method is same to Subindex01h.											
	05h	5th receive PDO mapped	0~4294967295	U32	rw	NO	All						
		Setting method is same to Subindex01h.											
	06h	6th receive PDO mapped	0~4294967295	U32	rw	NO	All						
		Setting method is same to Subindex01h.											
...													

	18h	24th receive PDO mapped	0~4294967295	U32	rw	NO	All
		Setting method is same to Subindex01h.					
1601h	-	Receive PDO mapping 2, the Subindex specification is same to 1600h.					
1602h	-	Receive PDO mapping 3, the Subindex specification is same to 1600h.					
1603h	-	Receive PDO mapping 4, the Subindex specification is same to 1600h.					

Do not map duplicate objects. The change of the repeated setting is unknown.

Subindex01h-18h of 1600h-1603h can only be changed when the ESM state is PreOP and subindex00h = 0. In addition, the status returns abort code (06010003h).

After the setting is changed, set the subindex number of subindex0h, and reflect PDO distribution object setting by converting ESM state to SafeOP.

Index	Sub-Index	Name/Description	Range	DateType	Access	PDO	Op-mode							
1A00h	00h	Number of entries	0~4294967295	U8	rw	NO	All							
		Subindex number of the object.												
	01h	1st transmit PDO mapped	0~4294967295	U32	rw	NO	All							
		Set the first mapping object.												
		<table border="1" style="width: 100%; border-collapse: collapse;"> <tr> <td style="width: 10%;">bit</td> <td style="width: 25%;">31 ... 16</td> <td style="width: 25%;">15 ... 8</td> <td style="width: 20%;">7 ... 0</td> </tr> <tr> <td></td> <td>Index number</td> <td>Sub-index number</td> <td>Bit length</td> </tr> </table>	bit	31 ... 16	15 ... 8	7 ... 0		Index number	Sub-index number	Bit length				
	bit	31 ... 16	15 ... 8	7 ... 0										
		Index number	Sub-index number	Bit length										
	02h	2nd transmit PDO mapped	0~4294967295	U32	rw	NO	All							
		Setting method is same to Subindex01h.												
	03h	3rd transmit PDO mapped	0~4294967295	U32	rw	NO	All							
		Setting method is same to Subindex01h.												
	04h	4th transmit PDO mapped	0~4294967295	U32	rw	NO	All							
		Setting method is same to Subindex01h.												
	05h	5th transmit PDO mapped	0~4294967295	U32	rw	NO	All							
Setting method is same to Subindex01h.														
06h	6th transmit PDO mapped	0~4294967295	U32	rw	NO	All								
	Setting method is same to Subindex01h.													
...								
18h	24th transmit PDO mapped	0~4294967295	U32	rw	NO	All								
	Setting method is same to Subindex01h.													
1A01h	-	Transmit PDO mapping 2, the Subindex specification is same to 1600h.												
1A02h	-	Transmit PDO mapping 3, the Subindex specification is same to 1600h.												
1A03h	-	Transmit PDO mapping 4, the Subindex specification is same to 1600h.												

Do not map duplicate objects. The change of the repeated setting is unknown.

Subindex01h-18h of 1A00h-1A03h can only be changed when the ESM state is PreOP and subindex00h = 0. In addition, the status returns abort code (06010003h).

After the setting is changed, set the subindex number of subindex0h, and reflect PDO distribution object setting by converting ESM state to SafeOP.

4-2-5. Sync manager 2/3 synchronization (1C32h, 1C33h)

The setting of Sync manager2 is executed as 1C32h (Sync manager 2 synchronization).
The setting of Sync manager3 is executed as 1C33h (Sync manager 3 synchronization).

Sync manager 2 synchronization (1C32h)

Index	Sub-Index	Name/Description	Range	Data Type	Access	PDO	Op-mode
1C32	00h	Number of entries	0~20h	U8	ro	NO	All
		Subindex number of the object. The value is fixed to 20h.					
	01h	Sync mode	0-65535	U16	rw	NO	All
		Set the synchronization mode of Sync Manager 2. 00h: FreeRun (not synchronized) 01h: SM2 (synchronized with SM 2 Event) 02h: DC SYNC0 (synchronized with Sync0 Event)					
	02h	Cycle time	0~4294967295	U32	rw	NO	All
		Set the cycle of Sync Manager. Please set it among 500000 (500μs), 1000000 (1ms), 2000000(2ms), 4000000(4ms). If a value other than the above is set, E-810 (abnormal protection of synchronization cycle setting) will occur.					
	03h	Shift time	0~4294967295	U32	rw	NO	All
		Offset time.					
	04h	Sync modes supported	0~65535	U16	ro	NO	All
		Set the supported synchronization type. BIT0: FreeRun mode supported 0: not support; 1: FreeRun mode supported This servo driver is set to 1. BIT1: SM synchronization mode supported 0: not support; 1: SM2 event synchronization supported This servo driver is set to 1. BIT4-2: DC synchronization mode supported 000b: not support 001b: DC sync0 event supported This servo driver is set to 001b. BIT6-5: output offset supported 00b: not support 01b: offset of local clock supported This servo driver is set to 00b. BIT15-7: Reserved					
1C32	05h	Minimum cycle time	0~4294967295	U32	ro	NO	All
		The minimum value of the communication cycle that can be set.					
	06h	Calc and copy time	0~4294967295	U32	ro	NO	All
		The time from SM2 event, sync0 event to ESC read completion. This time can also be extended when there is a deviation in the signal.					
	08h	Command	0~65535	U16	ro	NO	All
		Not support					
	09h	Delay time	0~4294967295	U32	ro	NO	All
		Not support					
	0Ah	Sync0 cycle time	0~4294967295	U16	ro	NO	All
		When DC SYNC0 (1C32h-01h=02h), the value of ESC register 09A0h is set. Except DC SYNC0, the setting is 0.					
	0Bh	Cycle time too small	0~65535	U16	ro	NO	All
		Not support					
	0Ch	SM-event missed	0~65535	U16	ro	NO	All
		Not support					
	0Dh	Shift time too short	0~65535	U16	ro	NO	All
		Not support					
	0Eh	RxPDO toggle failed	0~65535	U16	rw	NO	All
		Not support					

	20h	Sync error	0~1	BOOL	ro	NO	All
		Sync error					

This setting value is a reference value, not a guaranteed value.

Sync manager 3 synchronization (1C33h)

Index	Sub-Index	Name/Description	Range	DateType	Access	PDO	Op-mode	
1C33h	00h	Number of entries	0~20h	U8	ro	NO	All	
		The Subindex number of this object. The value is fixed to 20h.						
	01h	Sync mode	0~65535	U16	rw	NO	All	
		Set the synchronization mode of Sync Manager 2. 00h: FreeRun (not synchronized) 01h: SM2 (synchronized with SM 2 Event) 02h: DC SYNC0 (synchronized with Sync0 Event)						
		02h	Cycle time	0~4294967295	U32	rw	NO	All
	Set the cycle of Sync Manager. Please set it among 500000 (500μs), 1000000 (1ms), 2000000(2ms), 4000000(4ms). If a value other than the above is set, E-810 (abnormal protection of synchronization cycle setting) will occur.							
	03h	Shift time	0~4294967295	U32	rw	NO	All	
		Offset time.						
	04h	Sync modes supported	0~65535	U16	ro	NO	All	
		Set the supported synchronization type. BIT0: FreeRun mode supported 0: not support; 1: FreeRun mode supported This servo driver is set to 1. BIT1: SM synchronization mode supported 0: not support; 1: SM2 event synchronization supported This servo driver is set to 1. BIT4-2: DC synchronization mode supported 000b: not support 001b: DC sync0 event supported This servo driver is set to 001b. BIT6-5: output offset supported 00b: not support 01b: offset of local clock supported This servo driver is set to 00b. BIT15-7: Reserved						
1C33h		05h	Minimum cycle time	0~4294967295	U32	ro	NO	All
			The minimum value of the communication cycle that can be set.					
06h		Calc and copy time	0~4294967295	U32	ro	NO	All	
		The time from SM2 event, sync0 event to ESC read completion. This time can also be extended when there is a deviation in the signal.						
08h		Command	0~65535	U16	ro	NO	All	
		Not support						
09h		Delay time	0~4294967295	U32	ro	NO	All	
		Not support						
0Ah	Sync0 cycle time	0~4294967295	U16	ro	NO	All		
	The same value with 1C32h-0Ah							
0Bh	Cycle time too small	0~65535	U16	ro	NO	All		
	Not support							
0Ch	SM-event missed	0~65535	U16	ro	NO	All		
	Not support							
0Dh	Shift time too short	0~65535	U16	ro	NO	All		
	Not support							
0Eh	RxPDO toggle failed	0~65535	U16	rw	NO	All		
	Not support							
20h	Sync error	0~1	BOOL	ro	NO	All		
	Sync error							

This setting value is a reference value, not a guaranteed value.

1. DC (SYNC0 event synchronization)

synchronization method	Features
Synchronize the time information of other slave stations based on the time of the first axis	High precision, need to compensate at the main station side

The specification of DC synchronous mode in this servo driver is as follows:

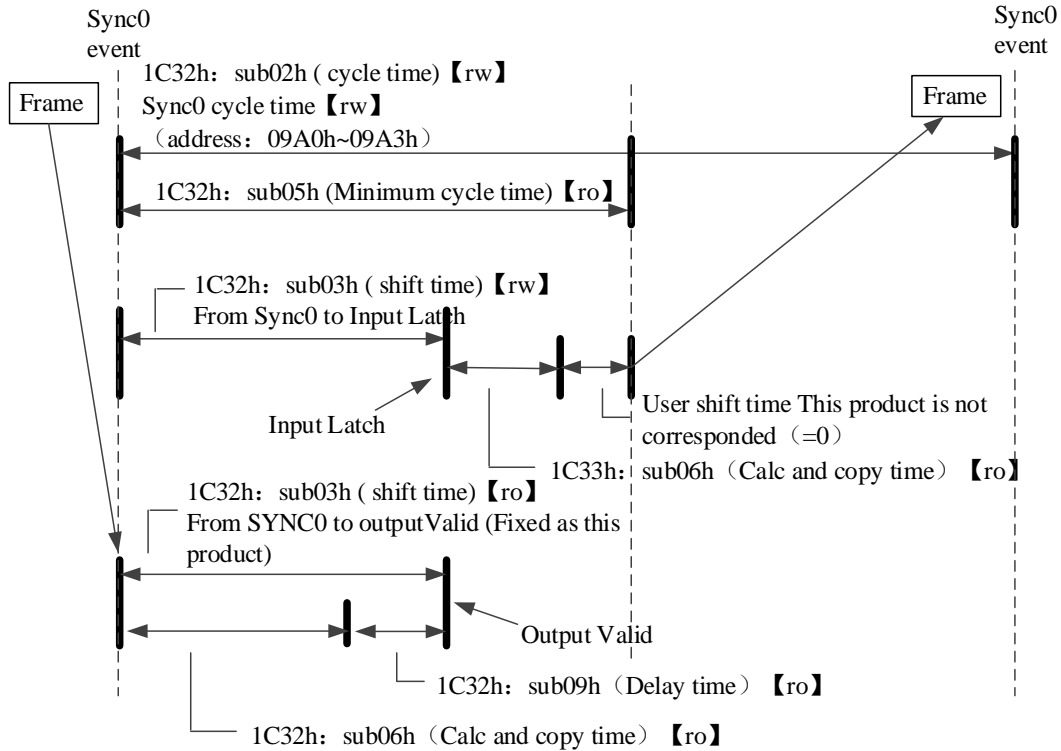

2. SM2 (SM2 event synchronization)

synchronization method	Features
Synchronize with RxPDO receiving time	No transmission delay compensation accuracy difference The transmission time must be ensured on the upper side (special hardware, etc.)

The specifications of SM2 synchronous mode in this servo driver are as follows:

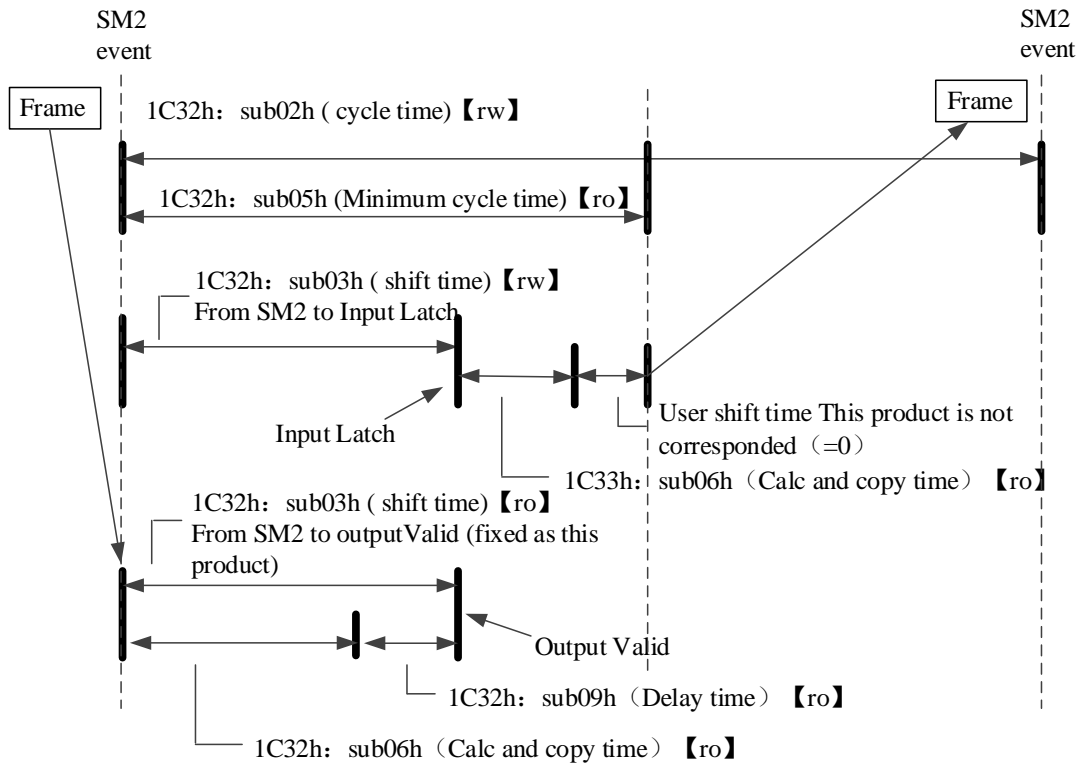

4-3. Driver Profile area (0x6000~0x6FFF)

4-3-1. Object list

Index	Sub-Index	Name
603Fh	00h	Abort connection option code
6040h	00h	Controlword
6041h	00h	Statusword
605Ah	00h	Quick stop option code
605Bh	00h	Shutdown option code
605Bh	00h	Disable operation option code
605Bh	00h	Halt option code
605Eh	00h	Fault reaction option code
6060h	00h	Modes of operation
6061h	00h	Modes of operation display
6062h	00h	Position demand value
6063h	00h	Position actual internal value
6064h	00h	Position actual value
6065h	00h	Following error window
6066h	00h	Following error time out
6067h	00h	Position window
6068h	00h	Position window time
6069h	00h	Velocity sensor actual value
606Bh	00h	Velocity demand value
606Ch	00h	Velocity actual value
606Dh	00h	Velocity window
606Eh	00h	Velocity window time
606Fh	00h	Velocity threshold
6070h	00h	Velocity threshold time
6071h	00h	Target torque
6072h	00h	Max torque
6073h	00h	Max current
6074h	00h	Torque demand
6075h	00h	Motor rated current
6076h	00h	Motor rated torque
6077h	00h	Torque actual value
6078h	00h	Current actual value
6079h	00h	DC link circuit voltage
607Ah	00h	Target position
607Bh	-	Position range limit
	00h	Highest sub-index supported
	01h	Min position range limit
607Bh	02h	Max position range limit
607Ch	00h	Home offset
607Dh	-	Software position limit
	00h	Number of entries
	01h	Min position limit
	02h	Max position limit
606Eh	00h	Polarity
607Fh	00h	Max profile velocity
6080h	00h	Max motor speed
6081h	00h	Profile velocity
6082h	00h	End velocity
6083h	00h	Profile acceleration
6084h	00h	Profile deceleration
6085h	00h	Quick stop deceleration

Index	Sub-Index	Name
6086h	00h	Motion profile type
6087h	00h	Torque slope
6088h	00h	Torque profile type
608Fh	-	Position encoder resolution
	00h	Highest sub-index supported
	01h	Encoder increments
	02h	Motor revolutions
6091h	-	Gear ratio
	00h	Number of entries
	01h	Motor revolutions
	02h	Shaft revolutions
6092h	-	Feed constant
	00h	Highest sub-index supported
	01h	Feed
	02h	Shaft revolutions
6098h	00h	Homing method
6099h	-	Homing speeds
	00h	Number of entries
	01h	Speed during search for switch
	02h	Speed during search for zero
609Ah	00h	Homing acceleration
60A3h	00h	Profile jerk use
60A4h	-	Profile jerk
	00h	Highest sub-index supported
	01h	Profile jerk1
	02h	Profile jerk2
60B0h	00h	Position offset
60B1h	00h	Velocity offset
60B2h	00h	Torque offset
60B8h	00h	Touch probe function
60B9h	00h	Touch probe status
60BAh	00h	Touch probe pos1 pos value
60BBh	00h	Touch probe pos1 neg value
60BCh	00h	Touch probe pos2 pos value
60BDh	00h	Touch probe pos2 neg value
60C2h	-	Interpolation time period
	00h	Highest sub-index supported
	01h	Interpolation time period value
	02h	Interpolation time index
60C5h	00h	Max acceleration
60C6h	00h	Max deceleration
60E3h	-	Supported homing method
	00h	Number of entries
	01h	1st supported homing method

	20h	32nd supported homing method
60F2h	00h	Positioning option code
60F4h	00h	Following error actual value
60FAh	00h	Control effort
60FCh	00h	Position demand internal value
60FDh	00h	Digital inputs
60FEh	-	Digital outputs
	00h	Number of entries
	01h	Physical outputs
	02	Bit mask
60FEh	00h	Target velocity

Index	Sub-Index	Name
6502h	00h	Supported drive modes

4-3-2. PDS (Power Drive Systems) specification

According to the user command or abnormal detection, the state transition of the PDS associated with the power control of the servo driver is defined as follows.

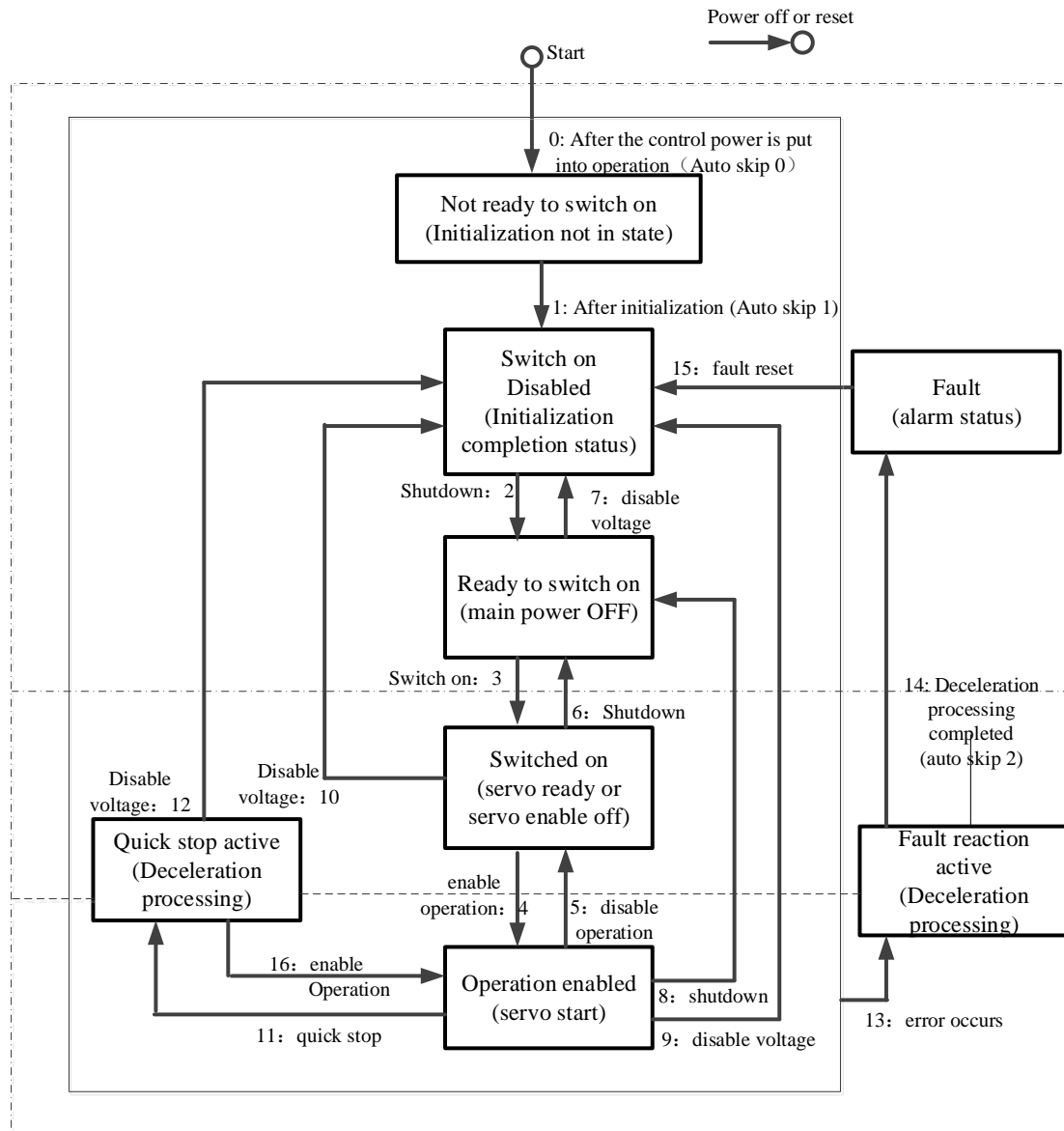

After migrating to operation enabled(servo is enabled), please increase the time to more than 100ms and input the action command.

The following table shows the PDS state migration events (migration conditions) and actions during migration. For the migration of PDS, the status migration is performed at the same time as the handshake is obtained (through 6041h: Statusword confirm the status has been converted and then send the next migration instruction).

PDS conversion		Event	Action
0	Auto skip 0	After the power supply is put into operation, or after the application layer is reset, it will automatically migrate.	After the power supply is put into operation, or after the application layer is reset, it will automatically migrate.
1	Auto skip 1	Automatic conversion after initialization.	Communications are established.

2	Shut down	The condition of receiving the shutdown instruction.	Nothing special.
3	Switch on	When the power supply is on, the condition of receiving the switch on command.	Nothing special.
4	Enable operation	The condition of receiving the enable operation instruction.	The drive function is effective. In addition, all previous set point data are cleared.
5	Disable operation	The situation of receiving the disable operation instruction.	Invalid driver function.
6	Shutdown	When the power supply is ON, the condition of receiving Shutdown instruction. Check out the condition that the power supply is OFF.	Nothing special.
7	Disable voltage	The condition of receiving Disable voltage instruction. The condition of receiving Quick stop instruction. When the ESM status is PreOP, SafeOP or OP, the condition of migrating to init.	Nothing special.
8	Shutdown	When the power supply is ON, the condition of receiving Shutdown instruction.	Driver function is invalid.
9	Disable voltage	the condition of receiving Disable voltage instruction.	Driver function is invalid.
10	Disable voltage	the condition of receiving Disable voltage instruction. the condition of receiving Quick stop instruction. When the ESM status is PreOP, SafeOP or OP, the condition of migrating to init.	Nothing special.
11	Quick stop	the condition of receiving Quick stop instruction.	Execute Quick stop function.
12	Disable voltage	When the quick stop selection code is the set value of 1, 2 and 3, and the quick stop action is completed. When the quick stop selection code is the set value of 5, 6 and 7, and the quick stop action is completed, the condition of receiving disable voltage instruction. Check the condition that the power supply is off.	Driver function is invalid.
13	Error occurs	Abnormal detection.	Execute Fault reaction function.
14	Auto skip 2	After the abnormal detection and deceleration processing is completed, it will be migrated automatically.	Driver function is invalid.
15	Fault reset	The situation of receiving the fault result instruction after the fault is removed.	If the fault factor does not exist, reset the fault status.
16	Enable operation	When the quick stop selection code is the set value of 5, 6 and 7, the condition of receiving Enable operation instruction.	Driver function is valid.

4-3-3. Controlword (6040h)

PDS status migration, etc. The command to control the slave station (servo driver) is set through 6040h (control word).

Index	Sub-Index	Name/Description	Range	DateType	Access	PDO	Op-mode																																
6040h	00h	Controlword	0~65535	U16	rw	RxPDO	All																																
Set the control command to the servo driver such as PDS state conversion.																																							
Bit information																																							
<table border="1" style="width:100%; border-collapse: collapse;"> <tr> <td style="width:12.5%;">15</td> <td style="width:12.5%;">14</td> <td style="width:12.5%;">13</td> <td style="width:12.5%;">12</td> <td style="width:12.5%;">11</td> <td style="width:12.5%;">10</td> <td style="width:12.5%;">9</td> <td style="width:12.5%;">8</td> </tr> <tr> <td colspan="6" style="text-align:center;">R</td> <td style="text-align:center;">oms</td> <td style="text-align:center;">h</td> </tr> <tr> <td style="width:12.5%;">7</td> <td style="width:12.5%;">6</td> <td style="width:12.5%;">5</td> <td style="width:12.5%;">4</td> <td style="width:12.5%;">3</td> <td style="width:12.5%;">2</td> <td style="width:12.5%;">1</td> <td style="width:12.5%;">0</td> </tr> <tr> <td style="text-align:center;">fr</td> <td colspan="3" style="text-align:center;">R</td> <td style="text-align:center;">eo</td> <td style="text-align:center;">qs</td> <td style="text-align:center;">ev</td> <td style="text-align:center;">so</td> </tr> </table>								15	14	13	12	11	10	9	8	R						oms	h	7	6	5	4	3	2	1	0	fr	R			eo	qs	ev	so
15	14	13	12	11	10	9	8																																
R						oms	h																																
7	6	5	4	3	2	1	0																																
fr	R			eo	qs	ev	so																																
r = reserved (not corresponding)				fr = fault reset																																			
oms = operation mode specific				eo = enable operation																																			

	(control mode based on bit) h = halt	qs = quick stop ev = enable voltage so = switch on
--	-----------------------------------------	----------------------------------------------------------

Command	bits of the controlword					PDS conversion
	bit7 fault reset	bit3 Enable operation	bit2 quick stop	bit1 Enable voltage	bit0 Switch on	
Shutdown	0	-	1	1	0	2, 6, 8
Switch on	0	0	1	1	1	3
Switch on + Enable operation	0	1	1	1	1	3+4
Enable operation	0	1	1	1	1	4, 16
Disable voltage	0	-	-	0	-	7, 9, 10, 12
Quick stop	0	-	0	1	-	7, 10, 11
Disable operation	0	0	1	1	1	5
Fault reset	0->1	-	-	-	-	13

The bit logic of the quick stop instruction is valid at 0.

Please execute other bit logic and the opposite actions.

Bit8 (HALT): 1, the motor deceleration pause is executed by 605Dh (halt selection code).

After the pause, the enable must be turned off to restart the action.

bit9, 6-4(operation mode specific):

The following shows the inherent change of OMS bit in the control mode (OP mode). (for details, please refer to the chapter of related objects of each control mode.)

Op-mode	Bit9	Bit6	Bit5	Bit4
pp	change on set-point	absolute /relative	change set immediately	new set-point
pv	-	-	-	-
tq	-	-	-	-
hm	-	-	-	start homing
csp	-	-	-	-
csv	-	-	-	-
cst	-	-	-	-

4-3-4. Statusword (6041h)

PDS status migration, etc. the command to control the slave station (servo driver) is set through 6040h (control word).

Index	Sub-Index	Name/Description	Range	DateType	Access	PDO	Op-mode																																
6041h	00h	Statusword	0~65535	U16	ro	TxPDO	All																																
Indicates the status of the servo driver.																																							
Bit information																																							
<table border="1"> <thead> <tr> <th>15</th> <th>14</th> <th>13</th> <th>12</th> <th>11</th> <th>10</th> <th>9</th> <th>8</th> </tr> </thead> <tbody> <tr> <td>r</td> <td></td> <td>oms</td> <td></td> <td>ila</td> <td>oms</td> <td>rm</td> <td>r</td> </tr> <tr> <th>7</th> <th>6</th> <th>5</th> <th>4</th> <th>3</th> <th>2</th> <th>1</th> <th>0</th> </tr> <tr> <td>w</td> <td>sod</td> <td>qs</td> <td>ve</td> <td>f</td> <td>oe</td> <td>so</td> <td>rsto</td> </tr> </tbody> </table>								15	14	13	12	11	10	9	8	r		oms		ila	oms	rm	r	7	6	5	4	3	2	1	0	w	sod	qs	ve	f	oe	so	rsto
15	14	13	12	11	10	9	8																																
r		oms		ila	oms	rm	r																																
7	6	5	4	3	2	1	0																																
w	sod	qs	ve	f	oe	so	rsto																																
r = reserved (not corresponding)				w = warning																																			
oms = operation mode specific (control mode based on bit)				sod = switch on disabled																																			
ila = internal limit active				qs = quick stop																																			
rm = remote				ve = voltage enabled																																			
				f = fault																																			
				oe = operation enabled																																			
				so = switched on																																			
				rsto = ready to switch on																																			

Bit6,5,3-0 (switch on disabled/quick stop/fault/operation enabled/switched on/ready to switch on): confirm PDS status according to this bit. The following shows the status and related bit.

StatusWord	PDS State	
xxxx xxxx x0xx 0000 b	Not ready to switch on	Initialization incomplete state
xxxx xxxx x1xx 0000 b	Switch on disabled	Initialization completion status
xxxx xxxx x01x 0001 b	Ready to switch on	Initialization completion status
xxxx xxxx x01x 0011 b	Switched on	Servo enable off/ servo ready
xxxx xxxx x01x 0111 b	Operation enabled	Servo enable on
xxxx xxxx x00x 0111 b	Quick stop active	Stop immediately
xxxx xxxx x0xx 1111 b	Fault reaction active	Error (alarm) judge
xxxx xxxx x0xx 1000 b	Fault	Error (alarm) status

bit4 (voltage enabled): In case of 1, it means that the power supply voltage is applied to PDS.

bit5 (quick stop): In the case of 0, PDS receives the quick stop request. The bit logic of quick stop is valid at 0. Please excute other bit logic and the opposite actions.

bit7 (warning): In the case of 1, a warning is occurring. When warning, PDS status will not change and motor will continue to operate.

bit9 (remote): In the case of 0(local), indicates the status that 6040 (controlword) cannot process. In the case of 1 (remote), indicates 6040 (Controlword) is in a manageable state. The ESM state changes to 1 when the transition is above PreOP.

bit13,12,10 (operation mode specific): the following means inherent change of OMS bit in control mode. (For details, please refer to the chapter of related objects of each control mode)

Op-mode	bit13	bit12	Bit10
pp	following error	set-point acknowledge	target reached
pv	-	speed	target reached
tq	-	-	target reached
hm	homing error	homing attained	target reached
csp	following error	drive follows command value	-
csv	-	drive follows command value	-
cst	-	drive follows command value	-

bit11 (internal limit active): The main reason for the internal limit is that the bit11 (internal limit active) of 6041h (status word) changes to 1.

bit15,14 (reserved): this bit is not used (fixed 0).

4-3-5. Control mode setting

1. Supported drive modes (6502h)

This servo driver can confirm the supported modes of operation according to 6502h (supported drive modes).

Index	Sub-Index	Name/Description	Range	DateType	Access	PDO	Op-mode
6502h	00h	Supported drive modes	0~4294967295	U32	ro	TxPDO	All
Supported Mode of operation. A value of 1 indicates the mode supported in this mode. Bit information							
		31...16		15...10		9	8
		r		r		cst	csv
		0		0		1	1
7	6	5	4	3	2	1	0
csp	r	hm	r	tq	pv	r	pp
1	0	1	0	1	1	0	1
bit	Mode of operation			Abbr	corresponding		
0	Profile position mode			pp	YES		
2	Profile velocity mode			pv	YES		
3	Torque profile mode			tq	YES		
5	Homing mode			hm	YES		
7	Cyclic synchronous position mode			csp	YES		

		8	Cyclic synchronous velocity mode	csv	YES
		9	Cyclic synchronous torque mode	cst	YES

2. Modes of operation (6060h)

The control mode is set through 6060h (modes of operation).

Index	Sub-Index	Name/Description	Range	DateType	Access	PDO	Op-mode
6060h	00h	Mode of operation	-128~127	I8	rw	RxPDO	All
Set the control mode of servo driver Non corresponding control mode setting inhibit.							
		bit	Mode of operation	Abbr	Corresponding		
		-128~ -1	Reserved	-	-		
		0	No mode changed/No mode assigned	-	-		
		1	Profile position mode	pp	YES		
		3	Profile velocity mode	pv	YES		
		4	Torque profile mode	tq	YES		
		6	Homing mode	hm	YES		
		8	Cyclic synchronous position mode	csp	YES		
		9	Cyclic synchronous velocity mode	csv	YES		
		10	Cyclic synchronous torque mode	cst	YES		
		11~127	Reserved	-	-		

Because 6060h (modes of operation) is default = (no mode change / no mode assigned), please set the control mode value to be used after the power is put into operation. When the set value of 6060h is 0 and the set value of 6061h is 0, if the PDS state is migrated to operation enabled, E-881 (control mode setting abnormal protection) occurs.

After the initial state of 6060h = 0 (no mode assigned) is transferred to the supported control mode (PP, PV, TQ, HM, CSP, CSV, CST), set 6060h = 0 again is seemed as "no mode changed", and the control mode can not be switched. (keep the previous control mode).

3. Modes of operation display (6061h)

The confirmation of the control mode inside the servo driver is performed according to 6061h (modes of operation display). After 6060h (modes of operation) is set, please confirm whether it is feasible to set this object action through detection.

Index	Sub-Index	Name/Description	Range	DateType	Access	PDO	Op-mode
6061h	00h	Mode of operation display	-128~127	I8	ro	TxPDO	All

Current control mode.			
bit	Mode of operation	Abbr	Corresponding
-128~ -1	Reserved	-	-
0	No mode changed/No mode assigned	-	-
1	Profile position mode	pp	YES
3	Profile velocity mode	pv	YES
4	Torque profile mode	tq	YES
6	Homing mode	hm	YES
8	Cyclic synchronous position mode	csp	YES
9	Cyclic synchronous velocity mode	csv	YES
10	Cyclic synchronous torque mode	cst	YES
11~127	Reserved	-	-

5. Motion instruction

5-1. Single axis function

5-1-1. Instruction list

Instruction	Function	Chapter
A_PWR	Axis enable	5-1-2-1
A_RST	Error reset	5-1-2-2
A_WRITE	Modify the electrical position	5-1-2-3
A_MODE	Modify the control mode	5-1-2-4
A_STOP	Stop motion	5-1-2-5
A_HALT	Pause	5-1-2-6
A_MOVEA	Absolute position motion	5-1-2-7
A_MOVER	Relative position motion	5-1-2-8
A_CMOVEA	Absolute position continuous motion	5-1-2-9
A_CMOVER	Relative position continuous motion	5-1-2-10
A_VELMOVE	Speed control motion	5-1-2-11
A_MOVESUP	Superimposed motion	5-1-2-12
A_HOME	HM homing	5-1-2-13
A_ZRN	Homing	5-1-2-14
A_GEARIN	Gear binding	5-1-2-15
A_GEAROUT	Gear unbinding	5-1-2-16
A_DRVA	Simple absolute position motion	5-1-2-17
A_DRVI	Simple relative position motion	5-1-2-18
A_PROBE	Probe function	5-1-2-19
A_CYCPOS	Periodic position control motion	5-1-2-20
A_CYCVEL	Periodic speed control motion	5-1-2-21
A_CYCTRQ	Periodic torque control motion	5-1-2-22

5-1-2. Instructions

5-1-2-1. Axis enable 【A_PWR】

(1) Overview

Enable the servo axis.

Axis enable [A_PWR]			
Execution condition	Normally open/close coil	Suitable model	XDH, XLH
Firmware	V3.6.1b and above	Software	3.7.4 and above

(2) Operand

Operand	Function	Type
S0	Output state word start address	16-bit, single word
S1	Output state bit start address	Bit
S2	Axis output terminal number	16-bit, single word

(3) Suitable soft component

Operand	Word soft component											Bit soft component					
	System								Constant	Module		System					
	D*	FD	TD*	CD*	DX	DY	DM*	DS*				X	Y	M*	S*	T*	C*
S0	●	●	●	●	●	●	●	●									
S1														●			
S2									●								

*: D means D, HD; TD means TD and HTD; CD means CD, HCD, HSCD and HSD; DM means DM and DHM; DS means DS and DHS; M means M, HM, SM; S means S, HS; T means T, HT; C means C, HC.

(4) Function and action

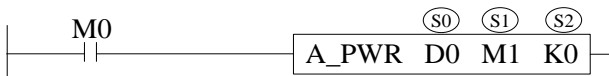

- S0 specifies the output state word start address
- S1 specifies the output state bit start address
- S2 specifies the axis terminal number
- When M0 is set to on, enable the specified axis of S2 and switch the axis to the operable state. When M0 is set to off, turn off the enabling of S2 specified axis and switch the axis to idle state
- After the instruction is executed, slave station single axis state (D20000+200*N) switch to 1

(5) Note

- If A_PWR is used more than once, it will cause double coil conflict
- The [command related] parameters can be monitored only when the conditions in front of the ladder chart are on
- The soft limit will be detected only when the axis is enabled
- A_PWR does not output axis related error codes
- The encoder axis does not need to be enabled.

(6) Related parameters

Output parameter	Parameter name	Data type	Unit	Note
S0	ErrCode	INT16U	-	Command error code
State parameter	Parameter name	Data type	Unit	Note
S1	PwrStat	BOOL	-	Enabled state
Axis number	Parameter name	Data type	Unit	Note
S2	Axis	INT16U	-	Axis number starts from 0

(7) Sequence diagram



(8) Application

Enable the axis K0:

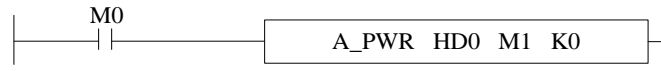

When there is no axis error, when M0 is set to on, K0 axis is enabled, the enabling state bit M1 is set to on, and the state machine D20000 + 200*N of the corresponding axis is 1, indicating the enabling static state.

5-1-2-2. Error reset 【A_RST】

(1) Overview

In case of single axis error, release the axis error state and switch to the normal operation state.

Error reset [A_RST]			
Execution condition	Rising/falling edge of the coil	Suitable model	XDH, XLH
Firmware	V3.6.1b and above	Software	3.7.4 and above

(2) Operand

Operand	Function	Type
S0	Output state word start address	16-bit, single word
S1	Output state bit start address	Bit
S2	Output axis terminal number	16-bit, single word

(3) Suitable soft component

Operand	Word soft component											Bit soft component					
	System								Constant	Module		System					
	D*	FD	TD*	CD*	DX	DY	DM*	DS*	K/H	ID	QD	X	Y	M*	S*	T*	C*
S0	●	●	●	●	●	●	●	●									
S1	●	●	●	●	●	●	●	●									
S2														●			
S3	●								●								

*: D means D, HD; TD means TD and HTD; CD means CD, HCD, HSCD and HSD; DM means DM and DHM; DS means DS and DHS; M means M, HM, SM; S means S, HS; T means T, HT; C means C, HC.

(4) function and action Suitable soft component

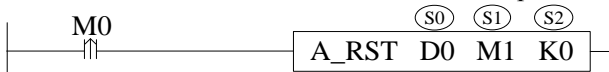

- S0 specifies the output state word start address
- S1 specifies the output state bit start address, occupies the relay S1~S1+2
- S2 specifies the axis terminal number
- When M0 changes from off → on, release the error state of the axis specified by S2. After successfully releasing the error state, S1 is set to on;
- After the command is executed, the single axis state (D20000 + 200*N) of the slave station is switched to 0 or 1 (0: axis enable is off, 1: axis enable is on).

(5) Note

- The command is triggered by the rising edge, which will only perform error reset when the rising edge of the coil is triggered
- A_RST command can clear the alarms allowed to be cleared by the driver. Some serious alarms need to clear the errors on the driver side before executing A_RST instruction
- Please confirm that the corresponding error has been processed before executing the error reset instruction
- After the command is executed successfully, the output status bit will not be automatically set to off. If necessary, please manually set the status bit to off.

(6) Related parameters

Output parameter	Parameter name	Data type	Unit	Note
S0	ErrCode	INT16U	-	Command error code
State parameter	Parameter name	Data type	Unit	Note
S1	Done	BOOL	-	Instruction execution complete
S1+1	Busy	BOOL	-	The instruction is being executed
S1+2	Error	BOOL	-	Instruction execution error
Axis number	Parameter name	Data type	Unit	Note
S2	Axis	INT16U		Axis number starts from 0

(7) Sequence diagram

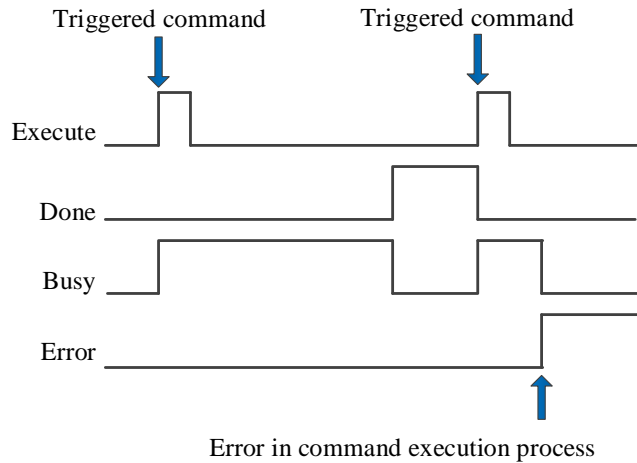

Note:

The command is triggered and the Busy signal is set on. When the command execution is completed, the Busy signal is reset and the Done signal is set on.

When there is an error during instruction execution, the Error signal is set on, other signals are reset, and the corresponding error code is output.

(8) Application

Clear the error state of axis K0:



When the axis has error (state machine $D20000+200*N=7$), the axis error can be cleared through the instruction A_RST (please check the corresponding error code $D20001 + 200*N$ first, and then clear the alarm after confirming that the error has been removed), and the state machine can be switched to the running state.

Before A_RST					After A_RST																																																																
<table border="1"> <thead> <tr> <th>寄存器</th> <th>监控值</th> <th>字长</th> <th>进制</th> <th>注释</th> </tr> </thead> <tbody> <tr> <td>D20000</td> <td>7</td> <td>单字</td> <td>1...</td> <td></td> </tr> <tr> <td>D20001</td> <td>2005</td> <td>单字</td> <td>1...</td> <td></td> </tr> <tr> <td>M1</td> <td>OFF</td> <td>位</td> <td>-</td> <td>执行成功</td> </tr> <tr> <td>M2</td> <td>OFF</td> <td>位</td> <td>-</td> <td>执行中</td> </tr> <tr> <td>M3</td> <td>OFF</td> <td>位</td> <td>-</td> <td>执行错误</td> </tr> </tbody> </table>					寄存器	监控值	字长	进制	注释	D20000	7	单字	1...		D20001	2005	单字	1...		M1	OFF	位	-	执行成功	M2	OFF	位	-	执行中	M3	OFF	位	-	执行错误	<table border="1"> <thead> <tr> <th>寄存器</th> <th>监控值</th> <th>字长</th> <th>进制</th> <th>注释</th> </tr> </thead> <tbody> <tr> <td>D20000</td> <td>0</td> <td>单字</td> <td>1...</td> <td></td> </tr> <tr> <td>D20001</td> <td>0</td> <td>单字</td> <td>1...</td> <td></td> </tr> <tr> <td>M1</td> <td>ON</td> <td>位</td> <td>-</td> <td>执行成功</td> </tr> <tr> <td>M2</td> <td>OFF</td> <td>位</td> <td>-</td> <td>执行中</td> </tr> <tr> <td>M3</td> <td>OFF</td> <td>位</td> <td>-</td> <td>执行错误</td> </tr> </tbody> </table>					寄存器	监控值	字长	进制	注释	D20000	0	单字	1...		D20001	0	单字	1...		M1	ON	位	-	执行成功	M2	OFF	位	-	执行中	M3	OFF	位	-	执行错误
寄存器	监控值	字长	进制	注释																																																																	
D20000	7	单字	1...																																																																		
D20001	2005	单字	1...																																																																		
M1	OFF	位	-	执行成功																																																																	
M2	OFF	位	-	执行中																																																																	
M3	OFF	位	-	执行错误																																																																	
寄存器	监控值	字长	进制	注释																																																																	
D20000	0	单字	1...																																																																		
D20001	0	单字	1...																																																																		
M1	ON	位	-	执行成功																																																																	
M2	OFF	位	-	执行中																																																																	
M3	OFF	位	-	执行错误																																																																	

5-1-2-3. Modify the electrical position 【A_WRITE】

(1) Overview

Modify the axis present position.

Modify the electrical position [A_WRITE]			
Execution condition	Rising/falling edge of the coil	Suitable model	XDH, XLH
Firmware	V3.6.1b and above	Software	3.7.4 and above

(2) Operand

Operand	Function	Type
S0	Input parameter start address	64-bit, 4 words
S1	Output state word start address	16-bit, single word
S2	Output state bit start address	Bit
S3	Axis output terminal number	16-bit, single word

(3) Suitable soft component

Operand	Word soft component										Bit soft component						
	System								Constant	Module		System					
	D*	FD	TD*	CD*	DX	DY	DM*	DS*	K/H	ID	QD	X	Y	M*	S*	T*	C*
S0	●	●	●	●	●	●	●	●									
S1	●	●	●	●	●	●	●	●									
S2														●			
S3	●								●								

*: D means D, HD; TD means TD and HTD; CD means CD, HCD, HSCD and HSD; DM means DM and DHM; DS means DS and DHS; M means M, HM, SM; S means S, HS; T means T, HT; C means C, HC.

(4) Function and action

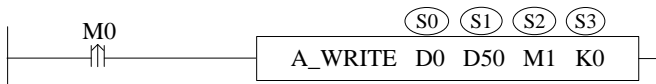

- S0 specifies input parameter start address, occupies register S0~S0+5
- S1 specifies output state word start address
- S2 specifies output state bit start address, occupies the relay S2~S2+2
- S3 specifies axis terminal number
- When M0 is from OFF→ON, modify the S3 specified axis present position (D20044+200*N) to S0 (N is axis number, starts from 0)
- After executing the instruction, slave station single axis state (D20000+200*N) will not change

(5) Related parameters

Input parameter	Parameter name	Data type	Unit	Note
S0	Position	FP64	Command unit	Target position
S0+4	Mode	INT16U	-	Position type* 0: absolute 1: relative
S0+5	BufferMode	INT16U	-	Buffer mode* 0: break in 1: buffer (Cannot support right now)
Output parameter	Parameter name	Data type	Unit	Note
S1	ErrCode	INT16U	-	Command error code
State parameter	Parameter name	Data type	Unit	Note

S2	Done	BOOL	-	Instruction execution complete
S2+1	Busy	BOOL	-	The instruction is being executed
S2+2	Error	BOOL	-	Instruction execution error
Axis number	Parameter name	Data type	Unit	Note
S3	Axis	INT16U	-	Axis number starts from 0

*Note: absolute, new present position = S0 input value.

Relative, new present position = old present position + S0 input value.

(6) Sequence diagram

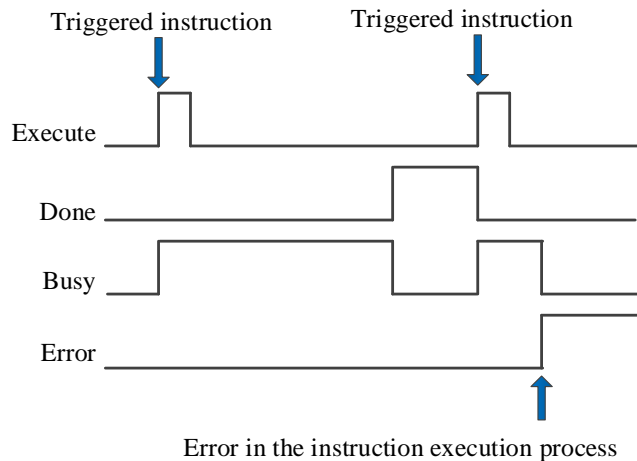

Note:

The command is triggered and the Busy signal is set on. When the command execution is completed, the Busy signal is reset and the Done signal is set on.

When there is an error during instruction execution, the Error signal is set on, other signals are reset, and the corresponding error code is output.

(7) Application

Modify the axis present position:

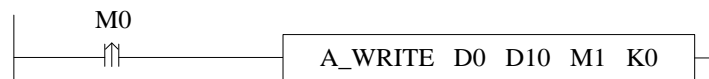

When absolute mode is selected to modify the position, the command configuration is as follows:

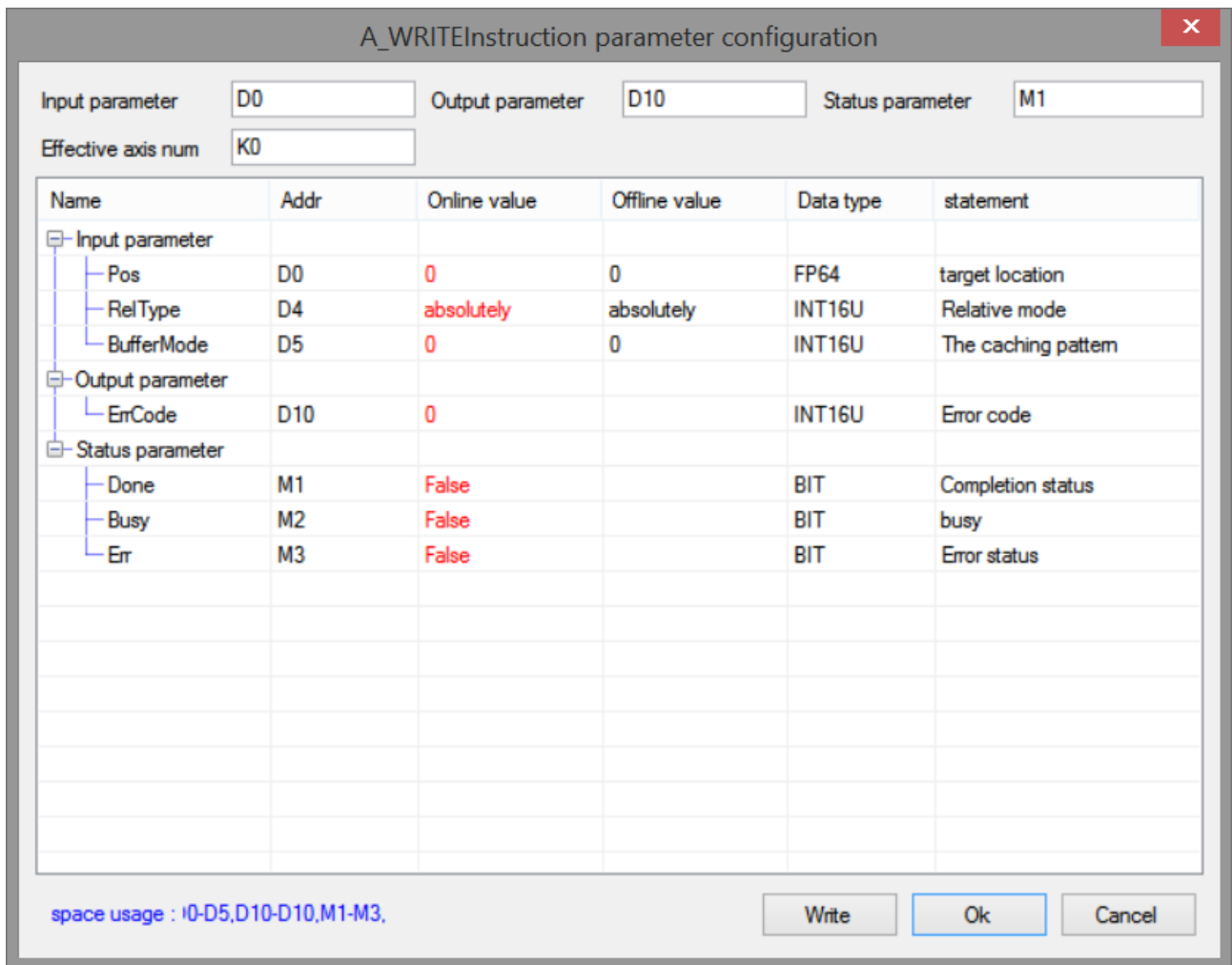

Before the instruction execution					After the instruction execution				
寄存器	监控值	字长	进制	注释	寄存器	监控值	字长	进制	注释
D20016	10000	双...	1...	轴0给定位置	D20016	0	双...	1...	轴0给定位置
D20044	10000	双...	1...	轴0反馈位置	D20044	0	双...	1...	轴0反馈位置

Note: before the command is executed, the current position of the axis is 10000, after absolute mode A_WRITE is executed, write the target location parameter to the current location (the target location in this example is 0).

When the relative mode is selected to modify the position, the command configuration is as follows:

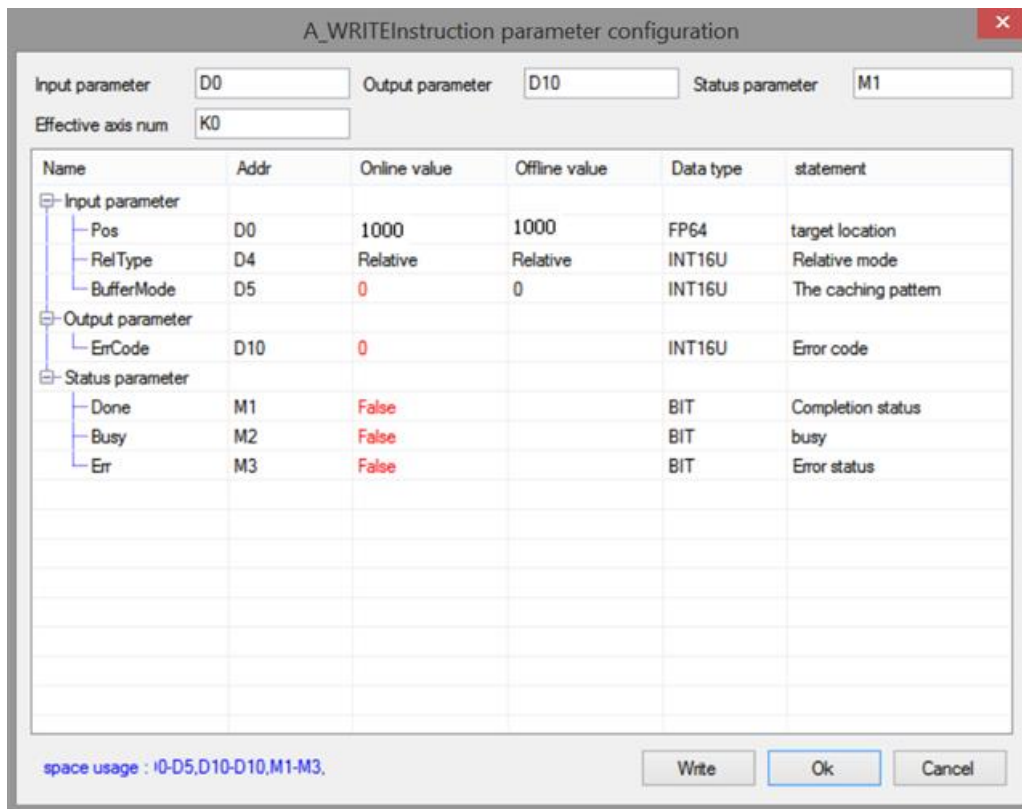

指令执行前					指令执行后				
寄存器	监控值	字长	进制	注释	寄存器	监控值	字长	进制	注释
D20016	10000	双...	1...	轴0给定位置	D20016	11000	双...	1...	轴0给定位置
D20044	10000	双...	1...	轴0反馈位置	D20044	11000	双...	1...	轴0反馈位置

Note: before executing the command, the current position of the axis is 10000, after executing relative mode A_WRITE, the current position changes to the original position plus the target position (in this example, the target position is 1000, plus the original position 10000, that is, the final position is 11000).

5-1-2-4. Modify the control mode 【A_MODE】

(1) Overview

Modify the control mode (6060h) of specified axis.

Modify the control mode [A_MODE]			
Execution condition	Rising/falling edge of the coil	Suitable model	XDH, XLH
Firmware	V3.6.1b and above	Software	3.7.4 and above

(2) Operand

Operand	Function	Type
S0	Input parameter start address	16-bit, single word
S1	Output state word start address	16-bit, single word
S2	Output state bit start address	Bit
S3	Axis output terminal number	16-bit, single word

(3) Suitable soft component

Operand	Word soft component										Bit soft component						
	System								Constant K/H	Module ID QD		System					
	D*	FD	TD*	CD*	DX	DY	DM*	DS*				X	Y	M*	S*	T*	C*
S0	●	●	●	●	●	●	●	●									
S1	●	●	●	●	●	●	●	●									
S2														●			
S3	●								●								

*: D means D, HD; TD means TD and HTD; CD means CD, HCD, HSCD and HSD; DM means DM and DHM; DS means DS and DHS; M means M, HM, SM; S means S, HS; T means T, HT; C means C, HC.

(4) Function and action



- S0 specifies input parameter start address
- S1 specifies output state word start address
- S2 specifies output state bit start address, occupies relay S2~S2+2
- S3 specifies axis terminal number, specified axis, only fit for EtherCAT bus axis
- When M0 is from OFF→ON, the control mode of S3 corresponding axis number is switched to S0 specified mode
- The control mode selection please refer to slave station Ethercat parameter 6060h
- After the instruction is executed, the single axis state (D20000+200*N) of slave station will not change.

(5) Related parameters

Input parameter	Parameter name	Data type	Unit	Note
S0	Mode	INT16U	-	Target mode The mode selection please refer to slave station Ethercat parameter 6060h
Output parameter	Parameter name	Data type	Unit	Note
S1	ErrCode	INT16U	-	Command error code
State parameter	Parameter name	Data type	Unit	Note
S2	Done	BOOL	-	Instruction execution complete
S2+1	Busy	BOOL	-	The instruction is being executed
S2+2	Error	BOOL	-	Instruction execution error
Axis	Parameter name	Data type	Unit	Note

number	Axis	INT16U	-	Axis number starts from 0
S3	Axis	INT16U	-	Axis number starts from 0

(6) Sequence diagram

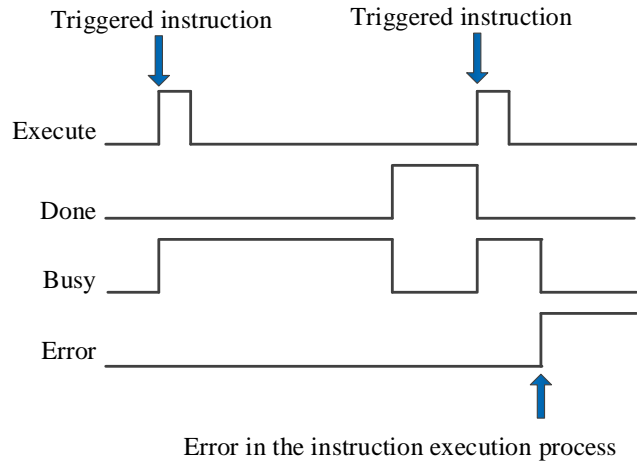

Note:

The command is triggered and the Busy signal is set on. When the command execution is completed, the Busy signal is reset and the Done signal is set on.

When there is an error during instruction execution, the Error signal is set on, other signals are reset, and the corresponding error code is output.

(7) Application

Modify the axis control mode to CSV mode:



The instruction configuration is shown as below:

5-1-2-5. Stop motion 【A_STOP】

(1) Overview

Deceleration stop or emergency stop the motion axis.

Stop motion [A_STOP]			
Execution condition	Rising/falling edge of the coil	Suitable model	XDH, XLH
Firmware	V3.6.1b and above	Software	3.7.4 and above

(2) Operand

Operand	Function	Type
S0	Input parameter start address	64-bit, four words
S1	Output state word start address	16-bit, single word
S2	Output state bit start address	Bit
S3	Axis output terminal number	16-bit, single word

(3) Suitable soft component

Operand	Word soft component											Bit soft component					
	System								Constant K/H	Module		System					
	D*	FD	TD*	CD*	DX	DY	DM*	DS*		ID	QD	X	Y	M*	S*	T*	C*
S0	●	●	●	●	●	●	●	●									
S1	●	●	●	●	●	●	●	●									
S2														●			
S3	●								●								

*: D means D, HD; TD means TD and HTD; CD means CD, HCD, HSCD and HSD; DM means DM and DHM; DS means DS and DHS; M means M, HM, SM; S means S, HS; T means T, HT; C means C, HC.

(4) Function and action



- S0 specifies input parameter start address, occupies the register S0~S0+8
- S1 specifies output state word start address
- S2 specifies output state bit start address, occupies the relay S2~S2+3
- S3 specifies the axis terminal number
- When M0 changes from off to on, the stop action is performed for the axis specified by S3, and the stop mode is specified by S0 + 8. If it is the deceleration stop mode, the axis is in the deceleration stop state after the command is executed, and other commands are invalid in this state. After the deceleration stop is completed, the axle is in the static state, and other commands can be executed at this time
- When it is executed in deceleration stop mode, the single axis state (D20000 + 200*N) of the slave station during deceleration stop is 6, and the single axis state after axis stop is 1.

(5) Notes

- The actual deceleration speed of the axis is the larger one between present motion deceleration speed and A_STOP deceleration speed
- The deceleration stop process cannot be interrupted by any other command, but can be interrupted by A_Stop command
- This instruction has higher priority than other instructions and will not be interrupted by any other instructions during the execution of the instruction.
- In the deceleration stop mode, it will be compared with the deceleration in the command and the deceleration of the executing motion command, and finally decelerate and stop with the larger value of the two.

(6) Related parameters

Input parameter	Parameter name	Data type	Unit	Note
S0	Deceleration	FP64	Command unit/s ²	Target deceleration
S0+4	Jerk	FP64	Command unit/s ³	Target jerk, the change speed of acceleration/deceleration
S0+8	StopMode	INT16U	-	Stop type 0: Deceleration stop 1: Emergency stop 2: Emergency stop and turn off enable
Output parameter	Parameter name	Data type	Unit	Note
S1	ErrCode	INT16U	-	Command error code
State parameter	Parameter name	Data type	Unit	Note
S2	Done	BOOL	-	Instruction execution complete
S2+1	Busy	BOOL	-	The instruction is being executed
S2+2	Abort	BOOL	-	Instruction is interrupted
S2+3	Error	BOOL	-	Instruction execution error
Axis number	Parameter name	Data type	Unit	Note
S3	Axis	INT16U	-	Axis number starts from 0

Stop type description:

① Deceleration stop

Decelerate and stop at the setting deceleration. If the deceleration is 0, execute at the default deceleration (default deceleration = default maximum deceleration SFD8088 * default deceleration percentage SFD8098). Take instruction A_VELMOVE and A_STOP as an example:

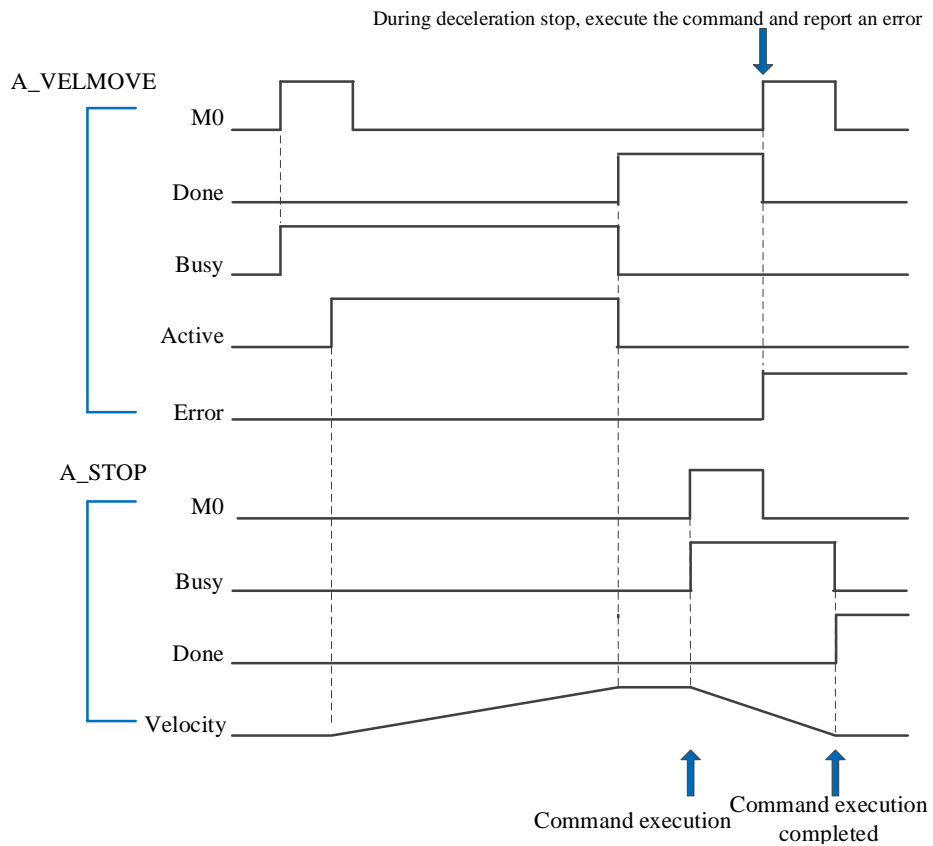

② Emergency stop

When the command is executed, stop the axis immediately.

Note: stopping the motion immediately will damage the machinery.

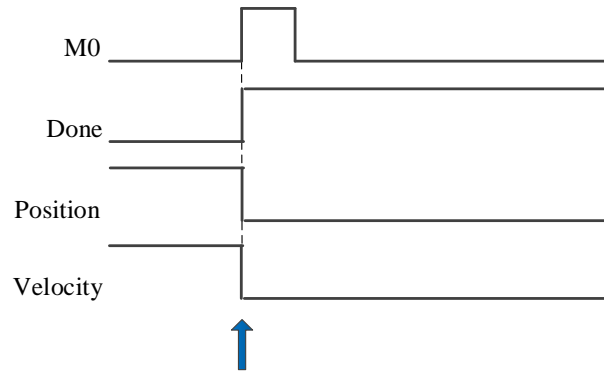

The position when triggered is the position where the axis stops

③ Emergency stop and turn off enable

At the same time of emergency stop, turn off the enabling of the axis.

5-1-2-6. Pause 【A_HALT】

(1) Overview

Decelerate and stop the moving axis.

Pause [A_HALT]			
Execution condition	Rising/falling edge of the coil	Suitable model	XDH, XLH
Firmware	V3.6.1b and above	Software	3.7.4 and above

(2) Operand

Operand	Function	Type
S0	Input parameter start address	64-bit, four words
S1	Output state word start address	16-bit, single word
S2	Output state bit start address	Bit
S3	Axis output terminal number	16-bit, single word

(3) Suitable soft component

Operand	Word soft component											Bit soft component					
	System								Constant K/H	Module		System					
	D*	FD	TD*	CD*	DX	DY	DM*	DS*		ID	QD	X	Y	M*	S*	T*	C*
S0	●	●	●	●	●	●	●	●									
S1	●	●	●	●	●	●	●	●									
S2														●			
S3	●								●								

*: D means D, HD; TD means TD and HTD; CD means CD, HCD, HSCD and HSD; DM means DM and DHM; DS means DS and DHS; M means M, HM, SM; S means S, HS; T means T, HT; C means C, HC.

(4) Function and action



- S0 specifies input parameter start address, occupies the register S0~S0+8
- S1 specifies output state word start address
- S2 specifies output state bit start address, occupies the relay S2~S2+4
- S3 specifies axis terminal number
- When M0 changes from off → on, the deceleration stop action is executed for the axis specified by S3, and the deceleration stop process can be interrupted
- After the command is executed, the single axis state (D20000 + 200*N) during deceleration stop is 2, and the single axis state switches to 1 after axis stop

(5) Related parameters

Input parameter	Parameter name	Data type	Unit	Note
S0	Deceleration	FP64	Command unit/s ²	Target deceleration
S0+4	Jerk	FP64	Command unit/s ³	Target jerk, the change speed of acceleration/deceleration
S0+8	BufferMode	INT16U	-	Buffer mode 0: interrupt mode 1: buffer mode
Output parameter	Parameter name	Data type	Unit	Note
S1	ErrCode	INT16U	-	Command error code
State parameter	Parameter name	Data type	Unit	Note

S2	Done	BOOL	-	Instruction execution complete
S2+1	Busy	BOOL	-	The instruction is being executed
S2+2	Active	BOOL	-	Command under control
S2+3	Abort	BOOL	-	Instruction interrupted
S2+4	Error	BOOL	-	Instruction execution error
Axis number	Parameter name	Data type	Unit	Note
S3	Axis	INT16U	-	Axis number starts from 0

Note:

The relationship between deceleration and jerk is same to A_MOVEA, please refer to chapter 5-1-2-7 item 5.

(6) Sequence diagram

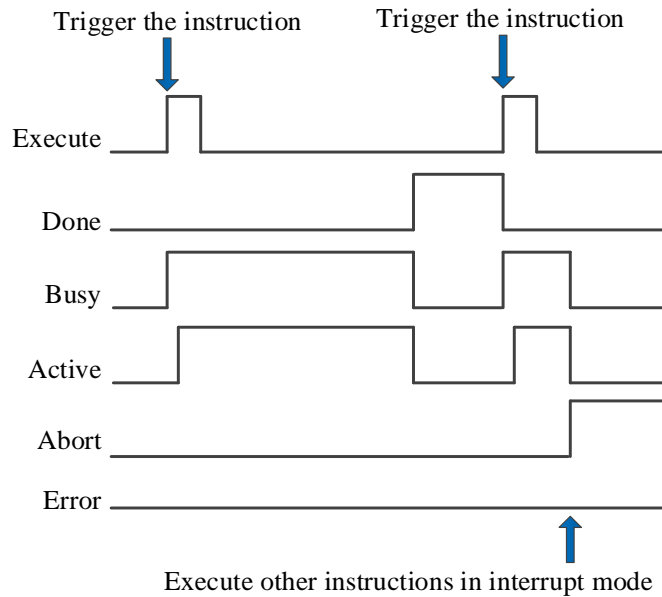

Note:

Generally, after the command is triggered, the Busy and Active signals are set, and reset after the command is executed. At the same time, the Done signal is set. Done will reset only after the command is triggered again, otherwise it will not reset automatically.

When the instruction is triggered in the buffer mode and there are currently instructions being executed, the Active signal will be set immediately. The execution of the current instruction ends. When the instruction is executed, the Busy signal will be set. After the execution of the instruction ends, the Busy and Active signals will be reset and the Done signal will be set.

When a new instruction is triggered in interrupt mode during instruction execution, the Busy and Active signals are reset immediately and the Abort signal is set.

When there is an error in the command, the Error signal is set, other signals are reset, and the corresponding error code is output.

5-1-2-7. Absolute position motion 【A_MOVEA】

(1) Instruction overview

The instruction moves in an absolute position, which can interrupt the current instruction and execute a new instruction during the movement.

Absolute position motion [A_MOVEA]			
Execution condition	Rising/falling edge of the coil	Suitable model	XDH, XLH
Firmware	V3.6.1b and above	Software	3.7.4 and above

(2) Operand

Operand	Function	Type
S0	Input parameter start address	64-bit, four words
S1	Output state word start address	16-bit, single word
S2	Output state bit start address	Bit
S3	Axis output terminal number	16-bit, single word

(3) Soft component

Operand	Word soft component										Bit soft component						
	System								Constant K/H	Module		System					
	D*	FD	TD*	CD*	DX	DY	DM*	DS*		ID	QD	X	Y	M*	S*	T*	C*
S0	●	●	●	●	●	●	●	●									
S1	●	●	●	●	●	●	●	●									
S2														●			
S3	●								●								

*: D means D, HD; TD means TD and HTD; CD means CD, HCD, HSCD and HSD; DM means DM and DHM; DS means DS and DHS; M means M, HM, SM; S means S, HS; T means T, HT; C means C, HC.

(4) Function and action



- S0 specifies input parameter start address, occupies the register S0~S0+22
- S1 specifies output state word start address
- S2 specifies output state bit start address, occupies the relay S2~S2+4
- S3 specifies axis terminal number
- Absolute position is the distance from zero point to target position
For example, the current position is 1000 and the set absolute position is 3000. Relative to the zero point, if the motor wants to move to the target point (i.e. set the absolute position), it needs to send another 2000 pulses at the current position.
- When M0 changes from off to on, move the absolute position of the axis specified by S3. Its position is S0, the speed is S0 + 4, the acceleration is S0 + 8, the deceleration is S0 + 12, and the jerk is S0 + 16. When the command execution is completed, S2 is set to on.
- When S0 + 22 [buffer mode] parameter is set to 0, the current instruction can interrupt other moving instructions. When S0 + 22 [buffer mode] parameter is set to 1, the instruction is stored in the buffer area after triggering, and the cached instruction is executed after the execution of other currently moving instructions is completed. Only one instruction can be cached for the same axis.
- After the command is executed, the single axis state (D20000 + 200*N) of the slave station is 2 during the movement, and the single axis state (D20000 + 200*N) of the slave station is switched to 1 after the movement.
- The direction is determined by the parameter target absolute position and the current position. It is positive when the target position is greater than the current position and negative when the target position is less than the current position.

(5) Related parameters

Input parameter	Parameter name	Data type	Unit	Note
S0	Position	FP64	Command unit	Target absolute position
S0+4	Velocity	FP64	Command unit /s	Target speed
S0+8	Acceleration	FP64	Command unit /s ²	Target acceleration speed
S0+12	Deceleration	FP64	Command unit /s ²	Target deceleration speed
S0+16	Jerk	FP64	Command unit /s ³	Target jerk speed, which is the change speed of acceleration and deceleration
S0+20	Continueusmode	INT16U	-	Continuous update, not supported temporarily
S0+21	Direction	INT16U	-	Direction. not supported temporarily 0: positive direction 1: negative direction 2: shortest path 3: current direction, i.e. consistent with the previous movement direction
S0+22	Buffermode	INT16U	-	Buffer mode 0: Interrupt mode 1: buffer mode
Output parameter	Parameter name	Data type	Unit	Note
S1	ErrCode	INT16U	-	Command error code
State parameter	Parameter name	Data type	Unit	Note
S2	Done	BOOL	-	Instruction execution complete
S2+1	Busy	BOOL	-	The instruction is being executed
S2+2	Active	BOOL	-	Command under control
S2+3	Abort	BOOL	-	Instruction is interrupted
S2+4	Error	BOOL	-	Instruction execution error
Axis number	Parameter name	Data type	Unit	Note
S3	Axis	INT16U	-	Axis number starts from 0

Note:

acceleration and deceleration reflect the speed change of the axis during acceleration and deceleration, that is, the change per second of the axis during acceleration and deceleration. Acceleration reflects the change ratio of acceleration and deceleration, that is, the change per second in the process of acceleration and deceleration from 0 to the target value. When in use, set appropriate parameters according to the actual situation and needs.

(6) Sequence diagram

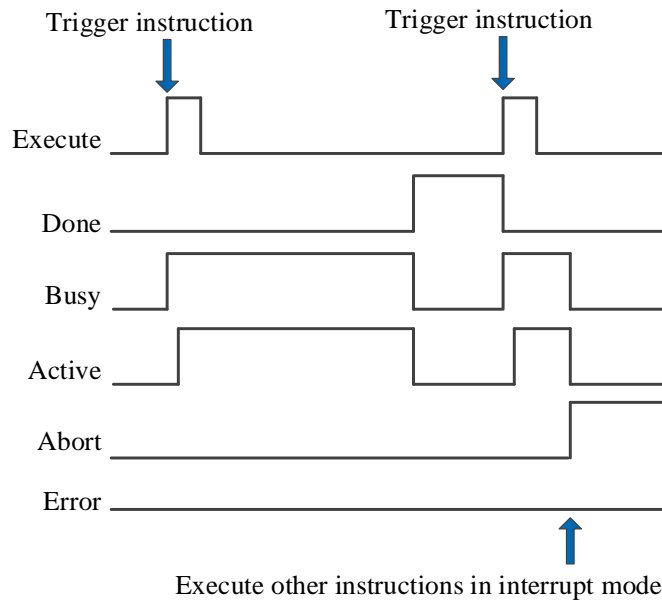

Explanation:

Generally, after the command is triggered, the Busy and Active signals are set, and reset after the command is executed. At the same time, the Done signal is set. Done will reset only after the command is triggered again, otherwise it will not reset automatically.

When the instruction is triggered in the buffer mode and there are currently instructions being executed, the Active signal will be set immediately. The execution of the current instruction ends. When the instruction is executed, the Busy signal will be set. After the execution of the instruction ends, the Busy and Active signals will be reset and the Done signal will be set.

When a new instruction is triggered in interrupt mode during instruction execution, the Busy and Active signals are reset immediately and the Abort signal is set.

When there is an error in the command, the Error signal is set, other signals are reset, and the corresponding error code is output.

(7) Application

The current position of motor 1 is 2000, and it is required to move to the position of 10000 pulses with the instruction A_MOVEA at the speed of 5000 pulses/s. After moving to the target position, let the motor move to the position of 20000 pulses at the speed of 6000 pulses/s. The acceleration and deceleration is 25000 pulses/s², and the jerk speed is 50000 pulses/s³.

In absolute position mode, the motor position diagram is as follows:

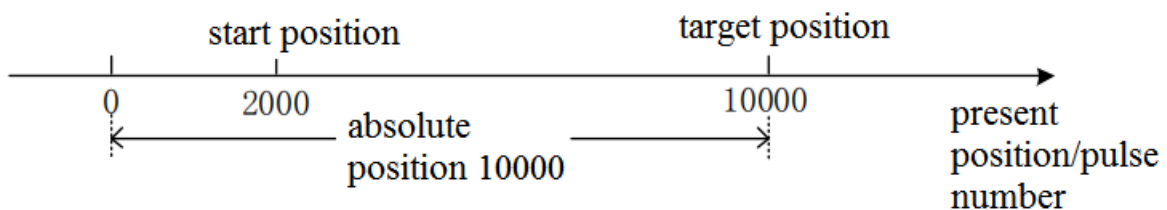

The target position in the command is the absolute position from zero point to target point, so moving to the position of 10000 pulses requires setting the target position 10000. Similarly, moving to the position of 20000 pulses requires setting the target position 20000.

The ladder diagram of absolute position mode is as follows:

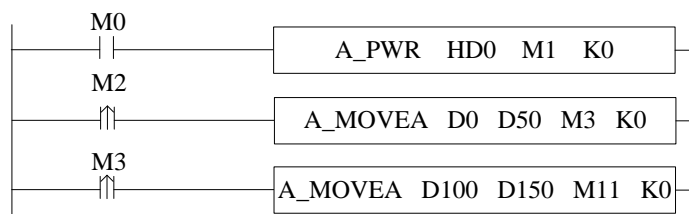

A_MOVEAInstruction parameter configuration ✕

Input parameter Output parameter Status parameter

Effective axis num

Name	Addr	Online value	Offline value	Data type	statement
[-] Input parameter					
Pos	D0	0	10000	FP64	Absolute target position
Vel	D4	0	5000	FP64	The target velocity, u/s
Acc	D8	0	25000	FP64	Acceleration, u/s ²
Dec	D12	0	25000	FP64	Minus the velocity, u/s ²
Jerk	D16	0	50000	FP64	Plus acceleration, u/s ³
ContinuousMode	D20	Donotupdate	Donotupdate	INT16U	Continuously updated
Direction	D21	Positivedirection	Positivedirection	INT16U	The direction of
BufferMode	D22	interrupt	interrupt	INT16U	The caching pattern
[-] Output parameter					
ErCode	D50	0		INT16U	Error code
[-] Status parameter					
Done	M3	False		BIT	Completion status
Busy	M4	False		BIT	busy
Active	M5	False		BIT	active
Abort	M6	False		BIT	Interrupt status
Err	M7	False		BIT	Error status

space usage : I0-D22,D50-D50,M3-M7, Write Ok Cancel

A_MOVEAInstruction parameter configuration ✕

Input parameter Output parameter Status parameter

Effective axis num

Name	Addr	Online value	Offline value	Data type	statement
[-] Input parameter					
Pos	D100	0	20000	FP64	Absolute target position
Vel	D104	0	6000	FP64	The target velocity, u/s
Acc	D108	0	25000	FP64	Acceleration, u/s ²
Dec	D112	0	25000	FP64	Minus the velocity, u/s ²
Jerk	D116	0	50000	FP64	Plus acceleration, u/s ³
ContinuousMode	D120	Donotupdate	Donotupdate	INT16U	Continuously updated
Direction	D121	Positivedirection	Positivedirection	INT16U	The direction of
BufferMode	D122	interrupt	interrupt	INT16U	The caching pattern
[-] Output parameter					
ErCode	D150	0		INT16U	Error code
[-] Status parameter					
Done	M11	False		BIT	Completion status
Busy	M12	False		BIT	busy
Active	M13	False		BIT	active
Abort	M14	False		BIT	Interrupt status
Err	M15	False		BIT	Error status

space usage : I100-D122,D150-D150,M11-M15, Write Ok Cancel

Note: first turn on the enable through A_PWR command. When M2 is turned from off to on, it runs to target position 1 with the parameters set in the first command. After reaching the target position, the state parameter M3 of the command is turned from off to on, so the second A_MOVEA is triggered, and finally run to target position 2 with the parameters set in the second command.

The execution position curve is as follows:

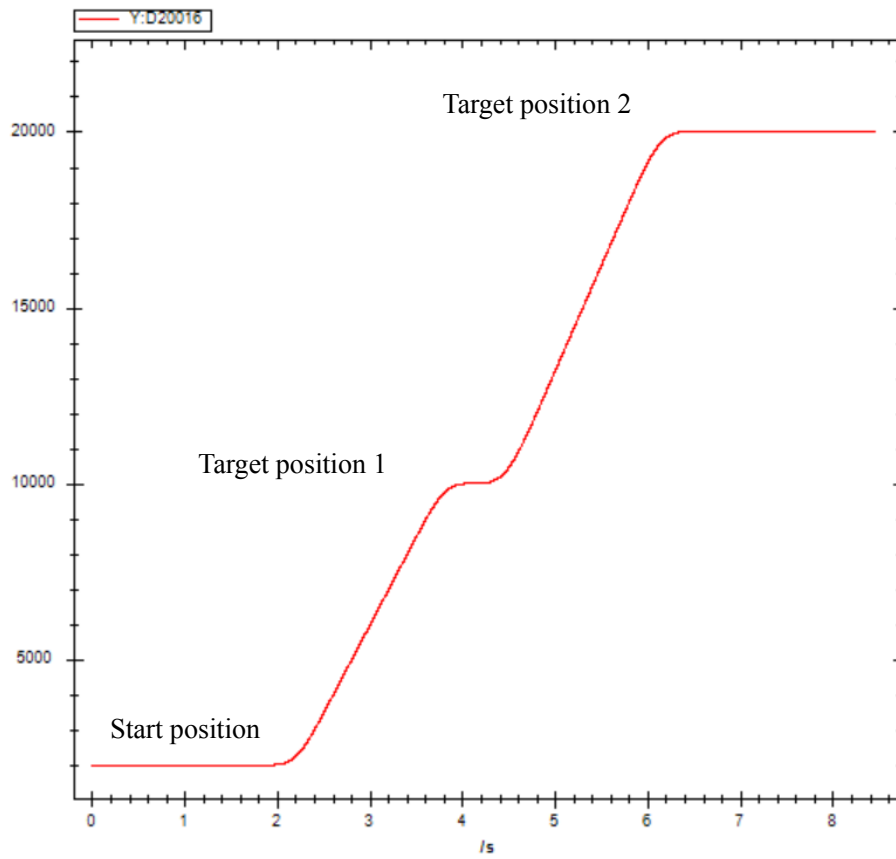

The execution speed curve is as follows:

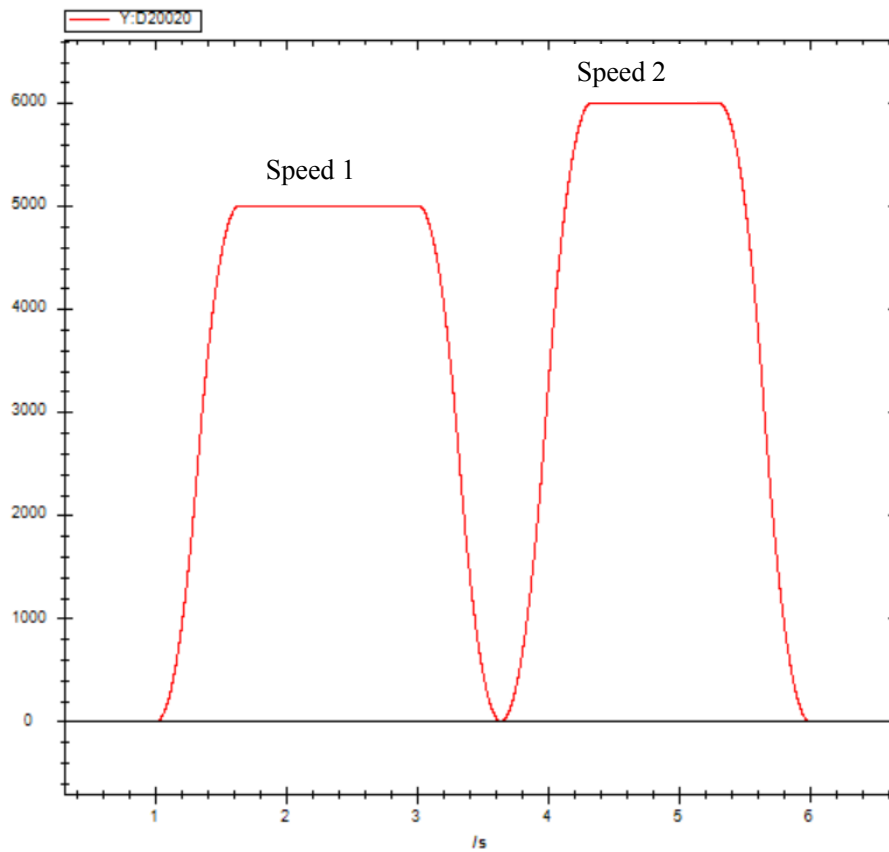

5-1-2-8. Relative position motion 【A_MOVER】

(1) Overview

The instruction moves in a relative position, which can interrupt the current instruction and execute a new instruction during the movement.

Relative position motion [A_MOVER]			
Execution condition	Rising/falling edge of the coil	Suitable model	XDH, XLH
Firmware	V3.6.1b and above	Software	3.7.4 and above

(2) Operand

Operand	Function	Type
S0	Input parameter start address	64-bit, four words
S1	Output state word start address	16-bit, single word
S2	Output state bit start address	Bit
S3	Axis output terminal number	16-bit, single word

(3) Suitable soft component

Operand	Word soft component										Bit soft component						
	System								Constant K/H	Module		System					
	D*	FD	TD*	CD*	DX	DY	DM*	DS*		ID	QD	X	Y	M*	S*	T*	C*
S0	●	●	●	●	●	●	●	●									
S1	●	●	●	●	●	●	●	●									
S2														●			
S3	●								●								

*: D means D, HD; TD means TD and HTD; CD means CD, HCD, HSCD and HSD; DM means DM and DHM; DS means DS and DHS; M means M, HM, SM; S means S, HS; T means T, HT; C means C, HC.

(4) Function and action



- S0 specifies input parameter start address, occupies the register S0~S0+22
- S1 specifies output state word start address
- S2 specifies output state bit start address, occupies the relay S2~S2+4
- S3 specifies axis terminal number
- The relative position is the distance from the current position to the target position;
For example, if the current position is 1000 and the set relative position is 3000, 3000 pulses will be sent at the current position, and the final position is 4000 relative to the zero position.
- When M0 changes from off to on, move the relative position of the axis specified by S3. Its position is S0, the speed is S0 + 4, the acceleration is S0 + 8, the deceleration is S0 + 12, and the jerk is S0 + 16. When the command execution is completed, S2 is set to on;
- When S0 + 22 [buffer mode] parameter is set to 0, the current instruction can interrupt other moving instructions. When S0 + 22 [buffer mode] parameter is set to 1, the instruction is stored in the buffer area after triggering, and the cached instruction is executed after the execution of other currently moving instructions is completed. Only one instruction can be cached for the same axis
- After the command is executed, the single axis state (D20000 + 200*N) of the slave station is 2 during the movement, and the single axis state (D20000 + 200*N) of the slave station is switched to 1 after the movement.
- The direction is determined by the positive and negative of target relative position

(5) Related parameters

Input parameter	Parameter name	Data type	Unit	Note
S0	Position	FP64	Command unit	Target relative position

Input parameter	Parameter name	Data type	Unit	Note
S0+4	Velocity	FP64	Command unit /s	Target speed
S0+8	Acceleration	FP64	Command unit /s ²	Target acceleration speed
S0+12	Deceleration	FP64	Command unit /s ²	Target deceleration speed
S0+16	Jerk	FP64	Command unit /s ³	Target jerk speed, the change speed of acceleration and deceleration
S0+20	Continueusmode	INT16U	-	Continuous update, not supported temporarily
S0+21	Direction	INT16U	-	Direction. Not supported temporarily
S0+22	Buffermode	INT16U	-	Buffer mode 0: interrupt mode 1: buffer mode
Output parameter	Parameter name	Data type	Unit	Note
S1	ErrCode	INT16U	-	Command error code
State parameter	Parameter name	Data type	Unit	Note
S2	Done	BOOL	-	Instruction execution complete
S2+1	Busy	BOOL	-	The instruction is being executed
S2+2	Active	BOOL	-	Command under control
S2+3	Abort	BOOL	-	Instruction is interrupted
S2+4	Error	BOOL	-	Instruction execution error
Axis number	Parameter name	Data type	Unit	Note
S3	Axis	INT16U	-	Axis number starts from 0

Note: the relationship between acceleration, deceleration and jerk speed is the same as that of A_MOVEA instruction, refer to chapter 5-1-2-7 item 5 related parameters for details.

(6) Sequence diagram

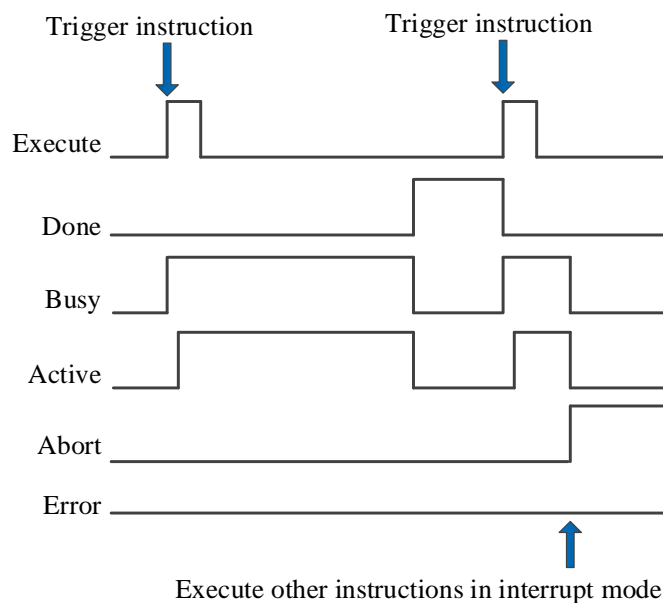

Explanation:

Generally, after the command is triggered, the Busy and Active signals are set, and reset after the command is executed. At the same time, the Done signal is set. Done will reset only after the command is triggered again, otherwise it will not reset automatically.

When the instruction is triggered in the buffer mode and there are currently instructions being executed, the Active signal will be set immediately. The execution of the current instruction ends. When the instruction is executed, the

Busy signal will be set. After the execution of the instruction ends, the Busy and Active signals will be reset and the Done signal will be set.

When a new instruction is triggered in interrupt mode during instruction execution, the Busy and Active signals are reset immediately and the Abort signal is set.

When there is an error in the command, the Error signal is set, other signals are reset, and the corresponding error code is output.

(7) Application

The current position of motor is 2000, and it is required to move to the position of 10000 pulses with the instruction A_MOVER at the speed of 5000 pulses/s. After moving to the target position, let the motor move to the position of 20000 pulses at the speed of 6000 pulses/s. The acceleration and deceleration is 25000 pulses/s², and the jerk speed is 50000 pulses/s³.

In relative position mode, the motor position diagram is as follows:

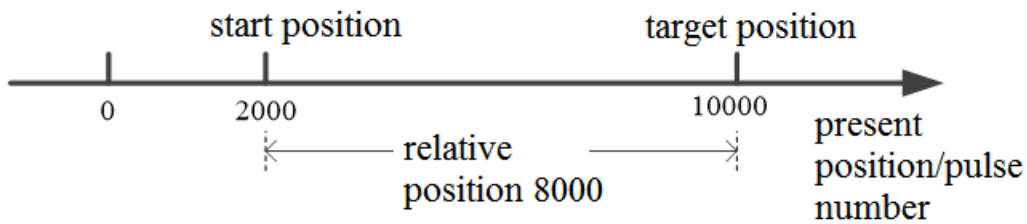

At the current position 2000, 8000 pulses need to be sent to run to the 10000 pulses position in the relative position mode. Similarly, 10000 pulses need to be sent to run to the 20000 pulses position.

The ladder diagram of relative position mode is as follows:

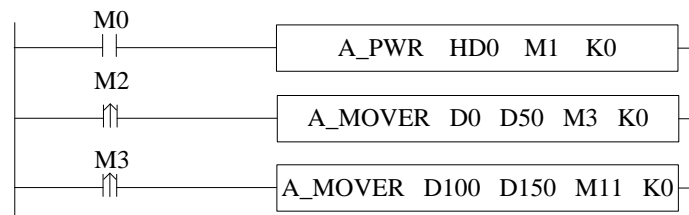

A_MOVERInstruction parameter configuration

Input parameter: D0 Output parameter: D50 Status parameter: M3

Effective axis num: K0

Name	Addr	Online value	Offline value	Data type	statement
Input parameter					
Pos	D0	0	8000	FP64	Target relative position
Vel	D4	0	5000	FP64	The target velocity, u/s
Acc	D8	0	25000	FP64	Acceleration, u/s ²
Dec	D12	0	25000	FP64	Minus the velocity, u/s ²
Jerk	D16	0	50000	FP64	Plus acceleration, u/s ³
ContinuousMode	D20	Donotupdate	Donotupdate	INT16U	Continuously updated
Direction	D21	Positivedirection	Positivedirection	INT16U	The direction of
BufferMode	D22	intemupt	intemupt	INT16U	The caching pattern
Output parameter					
ErrCode	D50	0		INT16U	Error code
Status parameter					
Done	M3	False		BIT	Completion status
Busy	M4	False		BIT	busy
Active	M5	False		BIT	active
Abort	M6	False		BIT	Intemrupt status
Err	M7	False		BIT	Error status

space usage : I0-D22,D50-D50,M3-M7

Write Ok Cancel

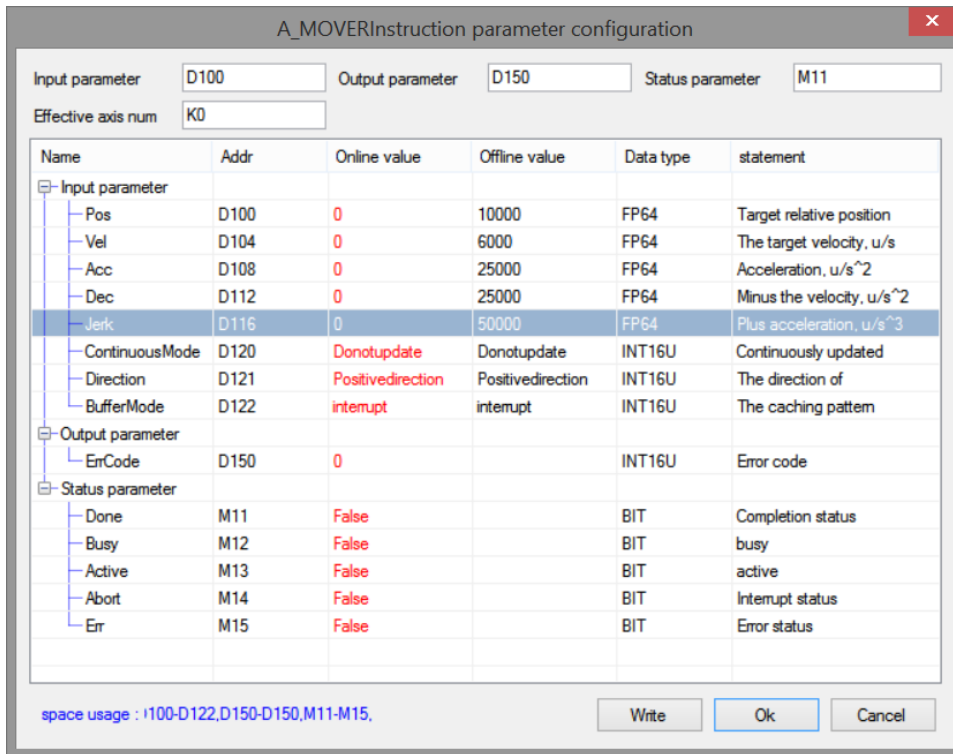

Note: first turn on the enable through A_PWR command. When M2 is turned from off to on, it runs to target position 1 with the parameters set in the first command. After reaching the target position, the state parameter M3 of the command is turned from off to on, so the second A_MOVER is triggered, and finally run to target position 2 with the parameters set in the second command.

The execution position curve is as follows:

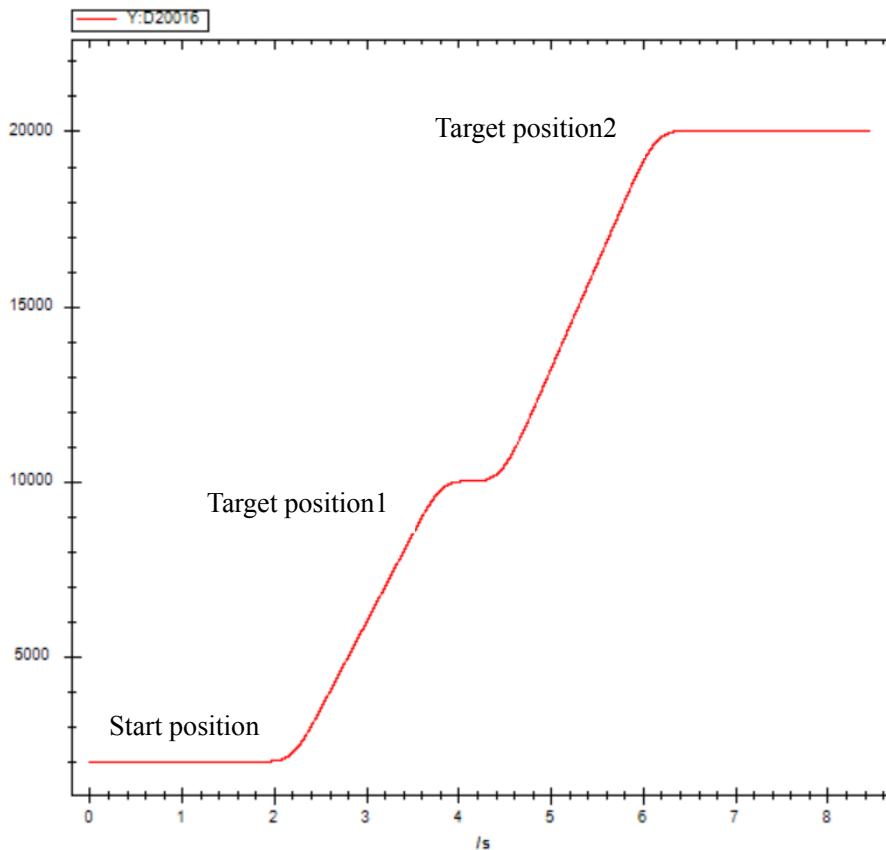

The execution speed is shown as below:

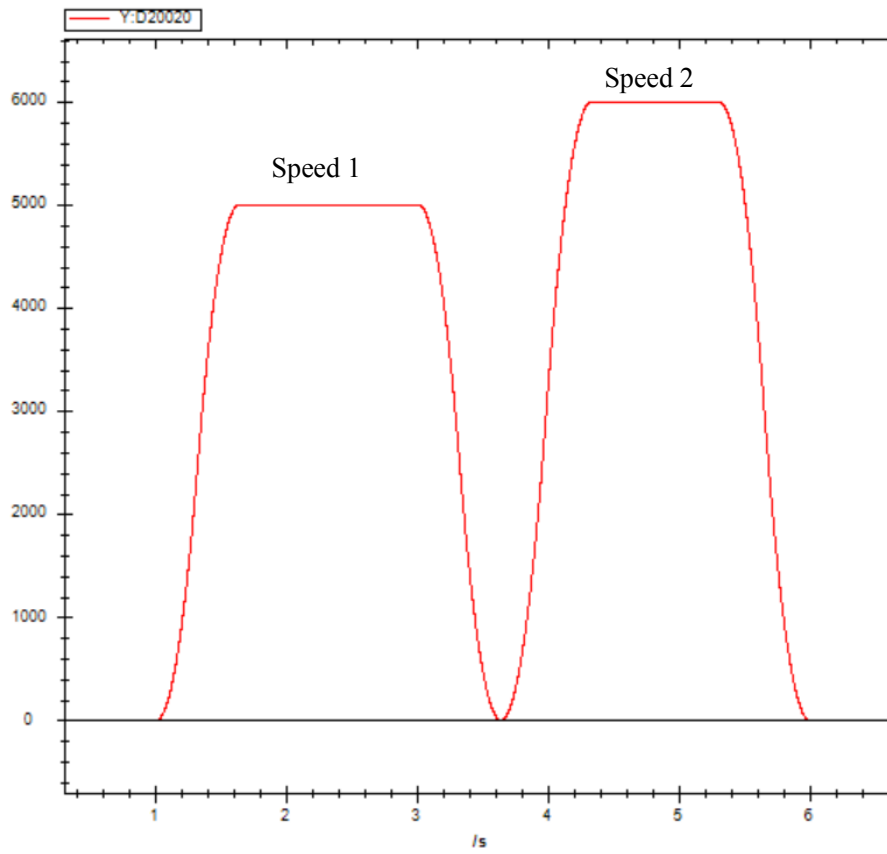

5-1-2-9. Absolute position continuous motion 【A_CMOVEA】

(1) Overview

The command moves in the absolute position and continues to run at the set final speed after the movement is completed.

Absolute position continuous motion [A_CMOVEA]			
Execution condition	Rising/falling edge of the coil	Suitable model	XDH, XLH
Firmware	V3.6.1b and above	Software	3.7.4 and above

(2) Operand

Operand	Function	Type
S0	Input parameter start address	64-bit, four words
S1	Output state word start address	16-bit, single word
S2	Output state bit start address	Bit
S3	Axis output terminal number	16-bit, single word

(3) Suitable soft component

Operand	Word soft component								Bit soft component										
	System								Constant	Module		System							
	D*	FD	TD*	CD*	DX	DY	DM*	DS*	K/H	ID	QD	X	Y	M*	S*	T*	C*		
S0	●	●	●	●	●	●	●	●											
S1	●	●	●	●	●	●	●	●											
S2														●					
S3	●								●										

*: D means D, HD; TD means TD and HTD; CD means CD, HCD, HSCD and HSD; DM means DM and DHM; DS means DS and DHS; M means M, HM, SM; S means S, HS; T means T, HT; C means C, HC.

(4) Function and action



- S0 specifies input parameter start, occupies the register S0~S0+26
- S1 specifies output state word start address
- S2 specifies output state bit start address, occupies the relay S2~S2+4
- S3 specifies the axis terminal number
- Absolute position is the distance from zero point to target position
For example, the current position is 1000 and the set absolute position is 3000. Relative to the zero point, if the motor wants to move to the target point (i.e. the set absolute position), it needs to send another 2000 pulses at the current position.
- When M0 changes from off to on, move the absolute position of the axis specified by S3. Its position is S0, the speed is S0 + 8, the acceleration is S0 + 12, the deceleration is S0 + 16, and the jerk speed is S0 + 20. When the command execution is completed, S2 is set to on and continues to move at the speed of S0 + 4.
- When S0 + 26 [buffer mode] parameter is set to 0, the current instruction can interrupt other moving instructions. When S0 + 26 [buffer mode] parameter is set to 1, the instruction is stored in the cache area after triggering, and the cached instruction is executed after the execution of other currently moving instructions is completed. Only one instruction can be cached for the same axis.
- After the command is executed, the single axis state (D20000 + 200*N) of the slave station during the movement is 3. After reaching the end position, if the termination speed is 0, the single axis state is switched to 1. If the termination speed is not 0, the single axis state remains 3.
- The direction is determined by the parameter target absolute position and the current position. It is positive when the target position is greater than the current position and negative when the target position is less than the current position.

(5) Notes

- It is necessary to set an appropriate target position. When the target position is too close to the actual position, the axis movement speed cannot reach the set value, the command will report an error and output the corresponding error code.
- The termination speed shall be less than or equal to the target speed. If the termination speed is greater than the target speed, it will continue to run at the target speed after the axis moves to the target position.

(6) Related parameters

Input parameter	Parameter name	Data type	Unit	Note
S0	Position	FP64	Command unit	Target absolute position
S0+4	Endvelocity	FP64	Command unit /s	Termination speed. The direction is consistent with the direction of motion, and the parameter value cannot be greater than the target speed.
S0+8	Velocity	FP64	Command unit /s	Target speed
S0+12	Acceleration	FP64	Command unit /s ²	Target acceleration speed
S0+16	Deceleration	FP64	Command unit /s ²	Target deceleration speed
S0+20	Jerk	FP64	Command unit /s ³	Target jerk speed, the changing speed of acceleration and deceleration.
S0+24	Continueusmode	INT16U	-	Continuously updated. Not supported at the moment.
S0+25	Direction	INT16U	-	Direction. 0: positive direction 1: negative direction 2: the shortest path 3: present direction, it is consistent with the previous movement direction
S0+26	Buffermode	INT16U	-	Buffer mode 0: interrupt mode 1: buffer mode
Output parameter	Parameter name	Data type	Unit	Note
S1	ErrCode	INT16U	-	Command error code
State parameter	Parameter name	Data type	Unit	Note
S2	Done	BOOL	-	Instruction execution complete
S2+1	Busy	BOOL	-	The instruction is being executed
S2+2	Active	BOOL	-	Command under control
S2+3	Abort	BOOL	-	Instruction is interrupted
S2+4	Error	BOOL	-	Instruction execution error
Axis number	Parameter name	Data type	Unit	Note
S3	Axis	INT16U	-	Axis number starts from 0

Note: the relationship of acceleration, deceleration and jerk speed is same to A_MOVEA, please refer to chapter 5-1-2-7 item5 for details.

(7) Sequence diagram

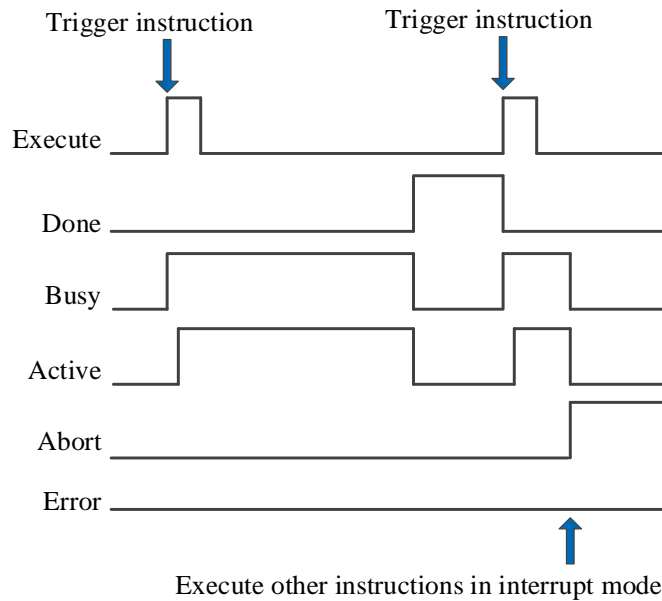

Explanation:

Generally, after the command is triggered, the Busy and Active signals are set, and reset after the command is executed. At the same time, the Done signal is set. Done will reset only after the command is triggered again, otherwise it will not reset automatically.

When the instruction is triggered in the buffer mode and there are currently instructions being executed, the Active signal will be set immediately. The execution of the current instruction ends. When the instruction is executed, the Busy signal will be set. After the execution of the instruction ends, the Busy and Active signals will be reset and the Done signal will be set.

When a new instruction is triggered in interrupt mode during instruction execution, the Busy and Active signals are reset immediately and the Abort signal is set.

When there is an error in the command, the Error signal is set, other signals are reset, and the corresponding error code is output.

(8) Application

The motor is required to move to the position of 10000 pulses at the speed of 5000 pulses/s and then move at a uniform speed at the speed of 3000 pulses/s. The acceleration and deceleration is 25000 pulses/s² and the jerk speed is 50000 pulses/s³. The ladder diagram is as follows:

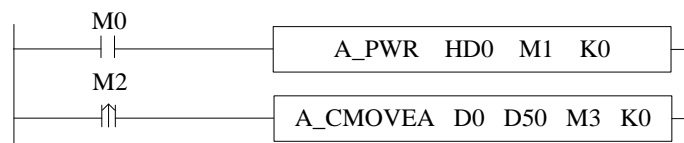

The command configuration is shown as below:

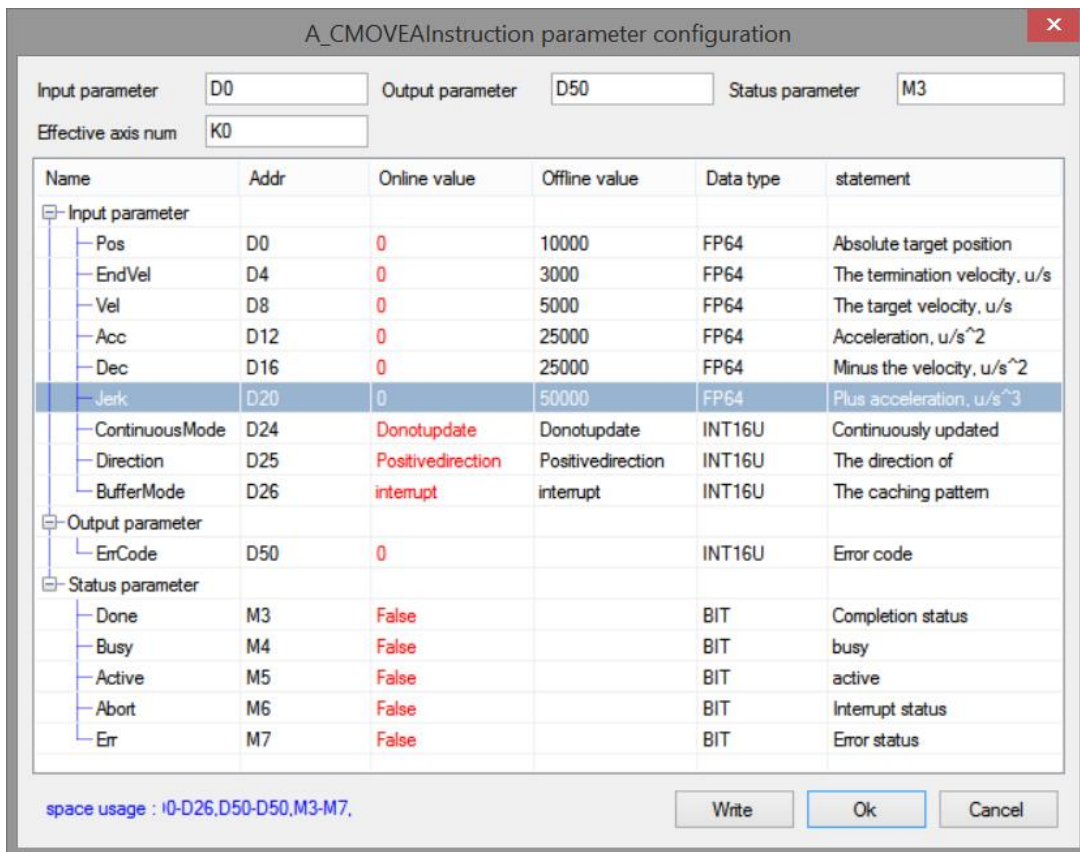

Note: To enable the axis through A_PWR instruction. After confirming that the enabling is successful, turn M2 from off → on and trigger A_CMOVEA command, which runs to the target absolute position at the set speed, and then runs continuously at the termination speed. During operation, the state machine D20000+200*N of the axis is 3.

Note: the direction of command termination speed is the same as that of running to the target position, and the termination speed cannot exceed the target speed.

The execution position curve:

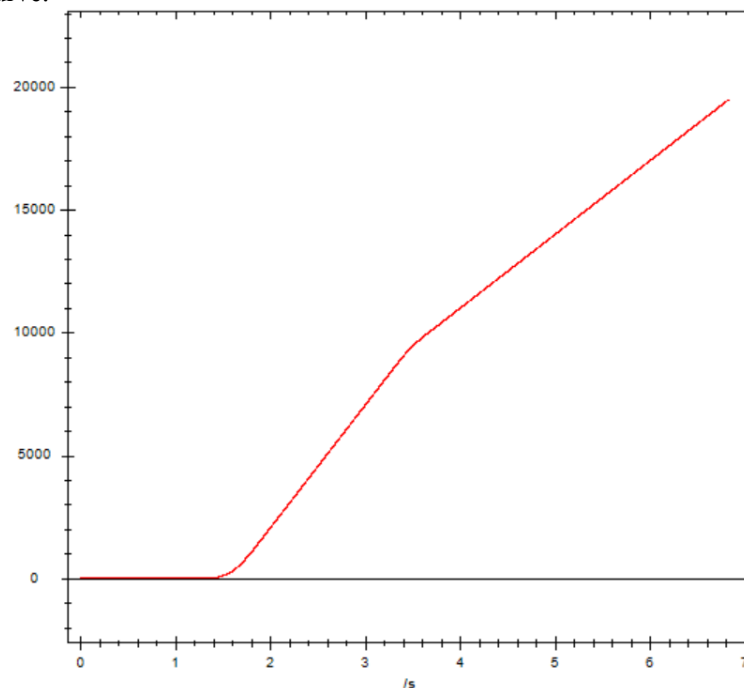

The execution speed curve:

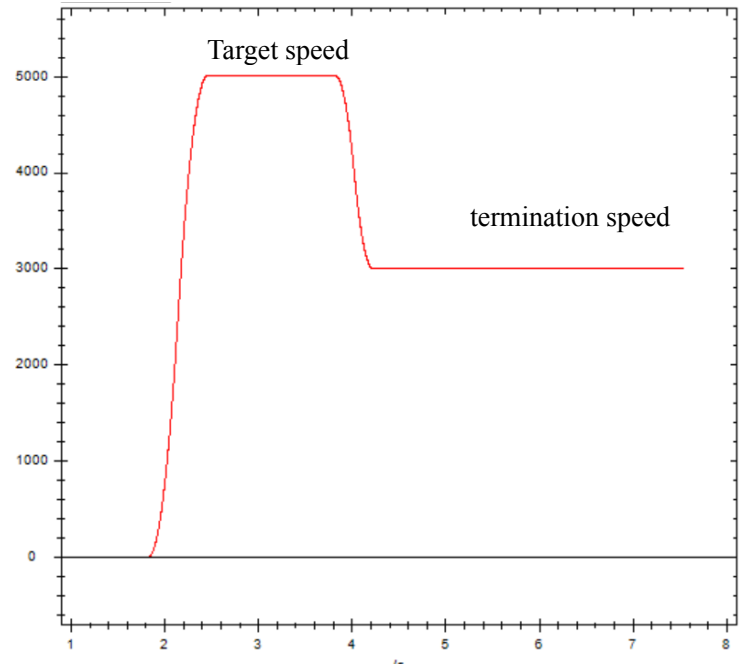

5-1-2-10. Relative position continuous motion 【A_CMOVER】

(1) Overview

The command moves in a relative position. Run continuously at the final speed after the movement is completed.

Relative position continuous motion [A_CMOVER]			
Execution condition	Rising/falling edge of the coil	Suitable model	XDH, XLH
Firmware	V3.7.1 and above	Software	3.7.4 and above

(2) Operand

Operand	Function	Type
S0	Input parameter start address	64-bit, four words
S1	Output state word start address	16-bit, single word
S2	Output state bit start address	Bit
S3	Axis output terminal number	16-bit, single word

(3) Suitable soft component

Operand	Word soft component										Bit soft component						
	System								Constant K/H	Module		System					
	D*	FD	TD*	CD*	DX	DY	DM*	DS*		ID	QD	X	Y	M*	S*	T*	C*
S0	●	●	●	●	●	●	●	●									
S1	●	●	●	●	●	●	●	●									
S2														●			
S3	●								●								

*: D means D, HD; TD means TD and HTD; CD means CD, HCD, HSCD and HSD; DM means DM and DHM; DS means DS and DHS; M means M, HM, SM; S means S, HS; T means T, HT; C means C, HC.

(4) Function and action



- S0 specifies the input parameter start address, occupies the register S0~S0+26
- S1 specifies the output state word start address
- S2 specifies the output state bit start address
- S3 specifies the axis output terminal number
- When M0 changes from off to on, the relative position movement is performed for the axis specified by S3, the moving distance is S0, the speed is S0 + 8, the acceleration is S0 + 12, the deceleration is S0 + 16, and the jerk speed is S0 + 20. When the command execution is completed, S2 is set to on and continues to move at the speed of S0 + 4
- When S0 + 26 [buffer mode] parameter is set to 0, the current instruction can interrupt other moving instructions. When S0 + 26 [buffer mode] parameter is set to 1, the instruction is stored in the cache area after triggering, and the cached instruction is executed after the execution of other currently moving instructions is completed. Only one instruction can be cached for the same axis.
- After the command is executed, the single axis state (D20000+200*N) of the slave station during the movement is 3. After reaching the end position, if the termination speed is 0, the single axis state is switched to 1. If the termination speed is not 0, the single axis state remains 3.

(5) Related parameters

Input parameter	Parameter name	Data type	Unit	Note
S0	Position	FP64	Command unit	Target relative position
S0+4	Endvelocity	FP64	Command	Termination speed. The direction is consistent

Input parameter	Parameter name	Data type	Unit	Note
			unit /s	with the direction of motion, and the parameter value cannot be greater than the target speed
S0+8	Velocity	FP64	Command unit /s	Target speed
S0+12	Acceleration	FP64	Command unit /s ²	Acceleration speed
S0+16	Deceleration	FP64	Command unit /s ²	Deceleration speed
S0+20	Jerk	FP64	Command unit /s ³	Jerk speed
S0+24	Continuousmode	INT16U	-	Continuous updating. Not supported at the moment
S0+25	Direction	INT16U	-	Direction (Not supported at the moment) 0: positive direction 1: negative direction 2: shortest path 3: present direction, consistent with the direction of last motion
S0+26	Buffermode	INT16U	-	Buffer mode 0: interrupt mode 1: buffer mode
Output parameter	Parameter name	Data type	Unit	Note
S1	ErrCode	INT16U	-	Command error code
State parameter	Parameter name	Data type	Unit	Note
S2	Done	BOOL	-	Instruction execution complete
S2+1	Busy	BOOL	-	The instruction is being executed
S2+2	Active	BOOL	-	Command under control
S2+3	Abort	BOOL	-	Instruction is interrupted
S2+4	Error	BOOL	-	Instruction execution error
Axis number	Parameter name	Data type	Unit	Note
S3	Axis	INT16U	-	Axis number starts from 0

Note: the relationship between deceleration and jerk speed is same to A_MOVEA, please refer to chapter 5-1-2-7 item 5 for details.

(6) Sequence diagram

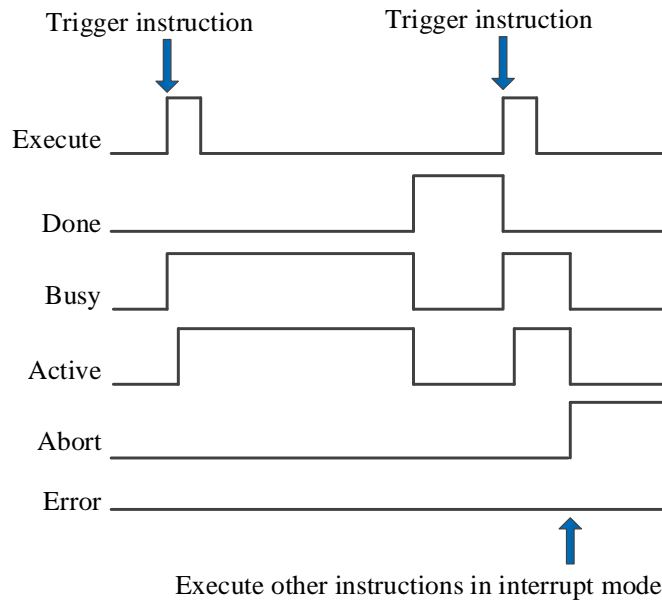

Explanation:

Generally, after the command is triggered, the Busy and Active signals are set, and reset after the command is executed. At the same time, the Done signal is set. Done will reset only after the command is triggered again, otherwise it will not reset automatically.

When the instruction is triggered in the buffer mode and there are currently instructions being executed, the Active signal will be set immediately. The execution of the current instruction ends. When the instruction is executed, the Busy signal will be set. After the execution of the instruction ends, the Busy and Active signals will be reset and the Done signal will be set.

When a new instruction is triggered in interrupt mode during instruction execution, the Busy and Active signals are reset immediately and the Abort signal is set.

When there is an error in the command, the Error signal is set, other signals are reset, and the corresponding error code is output.

(7) Application

For example, the current position of the motor is 4000. It is required that the motor move to the position of 10000 pulses at the speed of 5000 pulses/s and then move at a uniform speed at the speed of 3000 pulses/s. The acceleration and deceleration is 25000 pulses/s² and the jerk speed is 50000 pulses/s³. The ladder diagram is as follows:

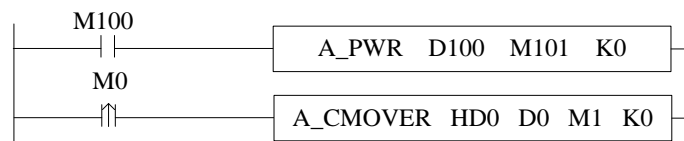

Since the current position of the motor is 4000, the [target position] parameter in the command should be 10000-4000 = 6000. The specific command parameter configuration is as follows:

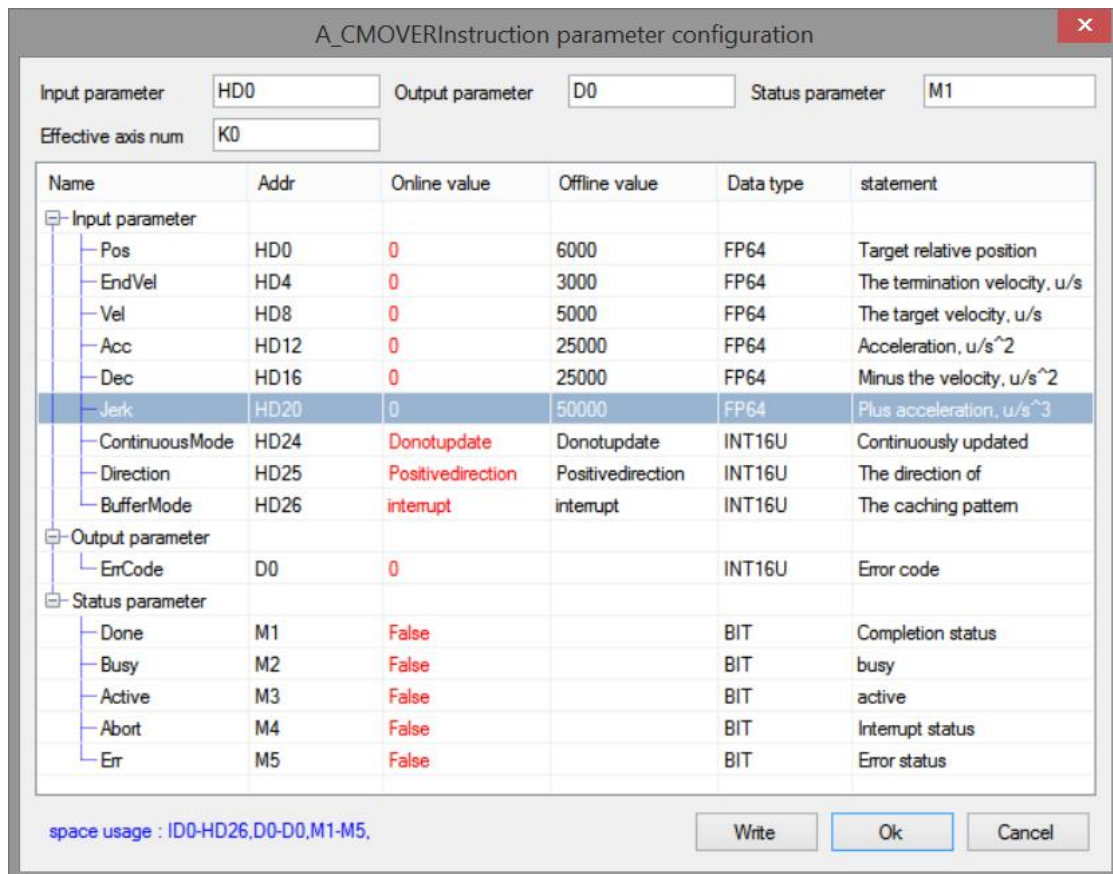

Note: to enable the axis with A_PWR instruction. After confirming that the enabling is successful, M0 is turned from off → on to trigger A_CMOVER command, the command runs to the target relative position at the set speed, and then runs continuously at the termination speed. During operation, the state machine D20000+200*N of the axis is 3.

Note: the direction of command termination speed is the same as that of running to the target position, and the termination speed cannot exceed the target speed.

The position curve is shown in the figure below:

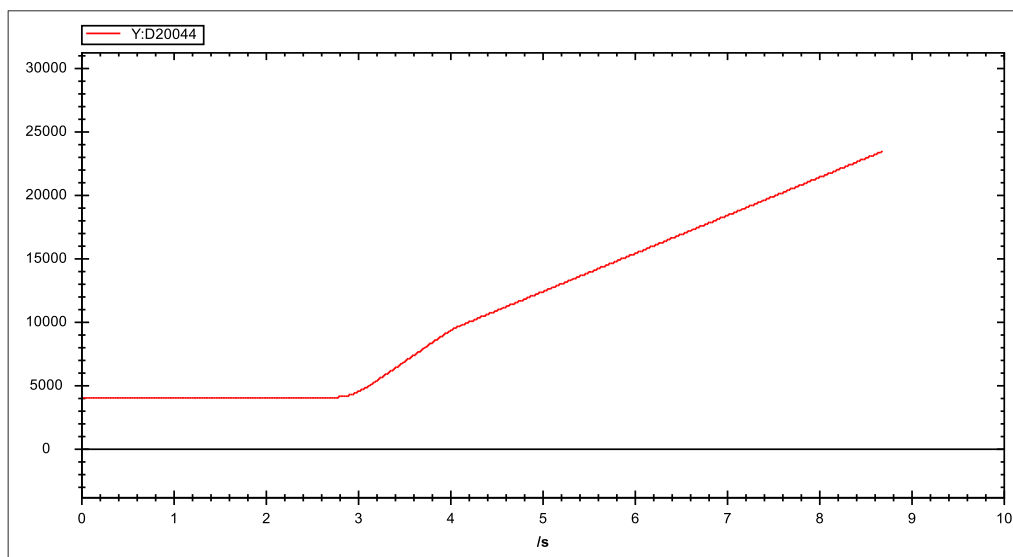

The speed curve is shown as below:

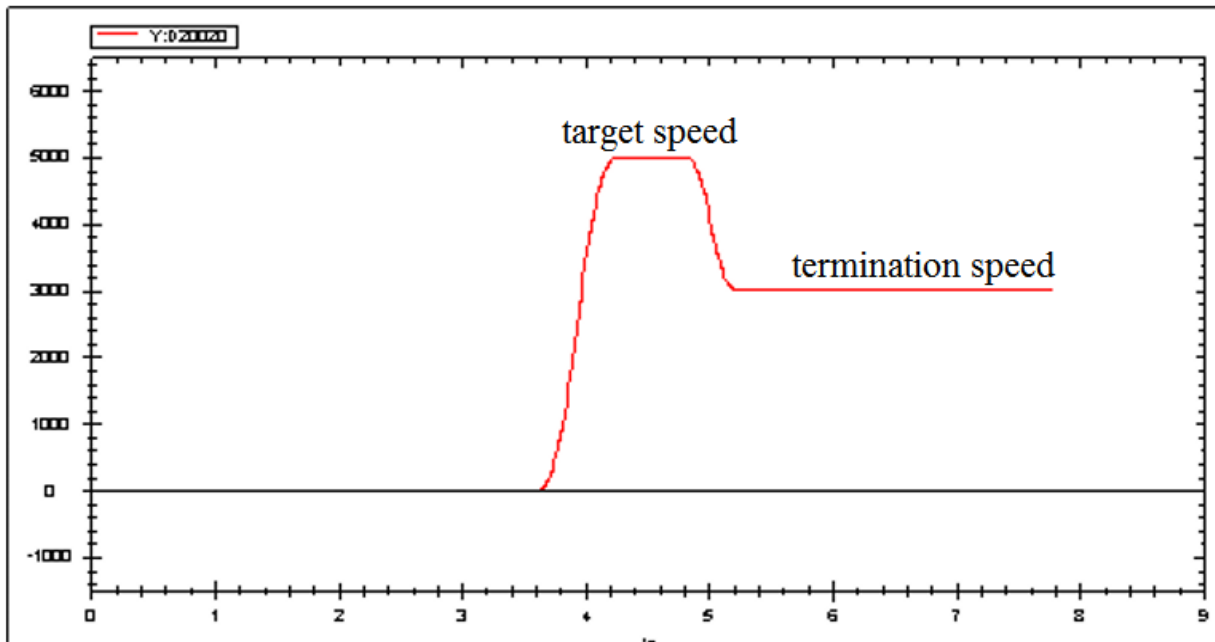

5-1-2-11. Speed control motion 【A_VELMOVE】

(1) Overview

The command runs continuously at the set speed.

Speed control motion [A_VELMOVE]			
Execution condition	Rising/falling edge of the coil	Suitable model	XDH, XLH
Firmware	V3.6.1b and above	Software	3.7.4 and above

(2) Operand

Operand	Function	Type
S0	Input parameter start address	64-bit, four words
S1	Output state word start address	16-bit, single word
S2	Output state bit start address	Bit
S3	Axis output terminal number	16-bit, single word

(3) Suitable soft component

Operand	Word soft component										Bit soft component						
	System								Constant	Module		System					
	D*	FD	TD*	CD*	DX	DY	DM*	DS*	K/H	ID	QD	X	Y	M*	S*	T*	C*
S0	●	●	●	●	●	●	●	●									
S1	●	●	●	●	●	●	●	●									
S2														●			
S3	●								●								

*: D means D, HD; TD means TD and HTD; CD means CD, HCD, HSCD and HSD; DM means DM and DHM; DS means DS and DHS; M means M, HM, SM; S means S, HS; T means T, HT; C means C, HC.

(4) Function and action



- S0 specifies input parameter start address, occupies the register S0~S0+18
- S1 specifies output state word start address
- S2 specifies output state bit start address, occupies the relay S2~S2+4
- S3 specifies the axis terminal number
- When M0 is from off → on, the speed control movement is carried out for the axis specified in S3, and the speed set by S0 will be maintained for continuous movement. After modifying the speed of S0, M0 is turned on again to make the modified speed effective. To stop the axis, set the value of S0 to 0 or use A_STOP/A_HALT instruction.
- When S0 + 26 [buffer mode] parameter is set to 0, the current instruction can interrupt other moving instructions. When S0 + 26 [buffer mode] parameter is set to 1, the instruction is stored in the cache area after triggering, and the cached instruction is executed after the execution of other currently moving instructions is completed. Only one instruction can be cached for the same axis.
- After the command is executed, the single axis state (D20000+200*N) of the slave station is switched to 3, and after stop by instruction A_STOP/A_HALT, the state switches to 1.
- The direction is determined by the positive/negative of the target speed of the parameter.

(5) Related parameters

Input parameter	Parameter name	Data type	Unit	Note
S0	Velocity	FP64	Command unit/s	Target speed
S0+4	Acceleration	FP64	Command unit /s ²	Target acceleration speed
S0+8	Deceleration	FP64	Command unit /s ²	Target deceleration speed

Input parameter	Parameter name	Data type	Unit	Note
S0+12	Jerk	FP64	Command unit /s ³	Target jerk speed, the change speed of the acceleration and deceleration
S0+16	Continueusmode	INT16U	-	Continuously updated. Not supported at the moment
S0+17	Direction	INT16U	-	Direction. Not supported at the moment
S0+18	Buffermode	INT16U	-	Buffer mode 0: interrupt mode 1: buffer mode
Output parameter	Parameter name	Data type	Unit	Note
S1	ErrCode	INT16U	-	Command error code
State parameter	Parameter name	Data type	Unit	Note
S2	Done	BOOL	-	Instruction execution complete
S2+1	Busy	BOOL	-	The instruction is being executed
S2+2	Active	BOOL	-	Command under control
S2+3	Abort	BOOL	-	Instruction is interrupted
S2+4	Error	BOOL	-	Instruction execution error
Axis number	Parameter name	Data type	Unit	Note
S3	Axis	INT16U	-	Axis number starts from 0.

Note: the relationship between acceleration/deceleration and jerk speed is same to A_MOVEA, please refer to chapter 5-1-2-7 item 5 for details.

(6) Sequence diagram

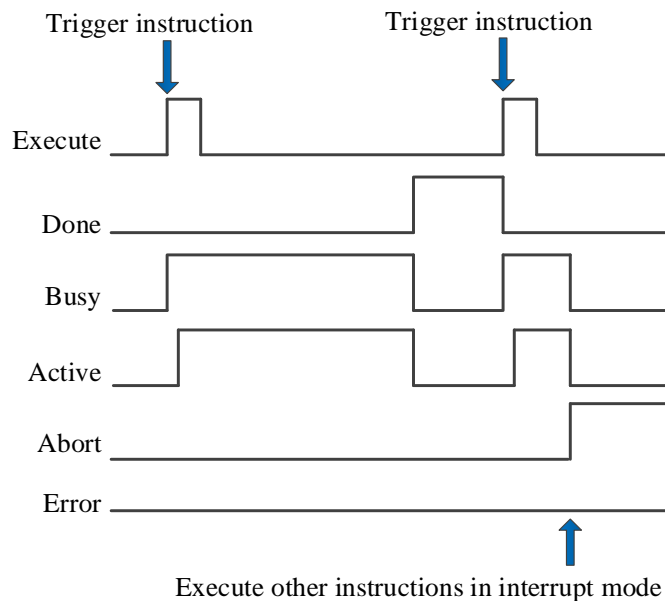

Explanation:

Generally, after the command is triggered, the Busy and Active signals are set, and reset after the command is executed. At the same time, the Done signal is set. Done will reset only after the command is triggered again, otherwise it will not reset automatically.

When the instruction is triggered in the buffer mode and there are currently instructions being executed, the Active signal will be set immediately. The execution of the current instruction ends. When the instruction is executed, the Busy signal will be set. After the execution of the instruction ends, the Busy and Active signals will be reset and the Done signal will be set.

When a new instruction is triggered in interrupt mode during instruction execution, the Busy and Active signals are reset immediately and the Abort signal is set.

When there is an error in the command, the Error signal is set, other signals are reset, and the corresponding error code is output.

(7) Application

For example, the motor is required to accelerate/decelerate to the speed of 5000 pulses/s at the acceleration and deceleration of 25000 pulses/ s² and jerk speed of 50000 pulses/s³, and maintain this speed for continuous movement. The ladder diagram is as follows:

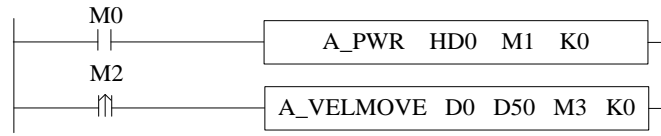

The command configuration is as follows:

The screenshot shows the 'A_VELMOVEInstruction parameter configuration' dialog box. It includes input, output, and status parameters, and a table of parameter details.

Name	Addr	Online value	Offline value	Data type	statement
Input parameter					
Vel	D0	0	5000	FP64	Speed, u/s
Acc	D4	0	25000	FP64	Acceleration, u/s ²
Dec	D8	0	25000	FP64	Minus the velocity, u/s ²
Jerk	D12	0	50000	FP64	Plus acceleration, u/s ³
ContinuousMode	D16	Donotupdate	Donotupdate	INT16U	Continuously updated
Direction	D17	Positivedirection	Positivedirection	INT16U	The direction of
BufferMode	D18	interrupt	interrupt	INT16U	The caching pattern
Output parameter					
ErrCode	D50	0		INT16U	Error code
Status parameter					
Done	M3	False		BIT	Completion status
Busy	M4	False		BIT	busy
Active	M5	False		BIT	active
Abort	M6	False		BIT	Interrupt status
Err	M7	False		BIT	Error status

space usage : !0-D18,D50-D50,M3-M7.

Note: To enable the axis through A_ PWR command. After confirming that the enabling is successful, turn M2 from off → on and trigger A_VELMOVE command, which performs acceleration/deceleration with the set parameters, and then runs continuously at the target speed. During operation, the state machine D20000+200*N of the axis is 3.

When the running speed is greater than the target speed, the speed curve after command execution is as follows:

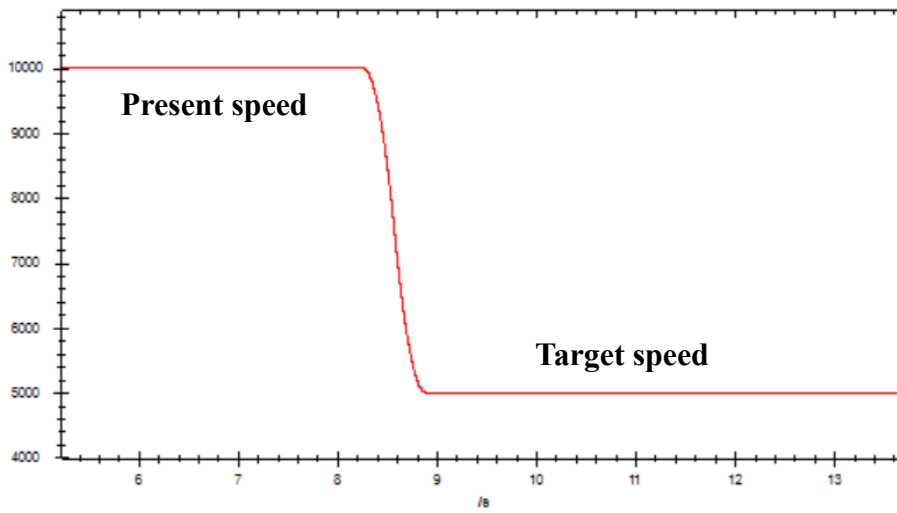

When the running speed is less than the target speed, the speed curve after command execution is as follows:

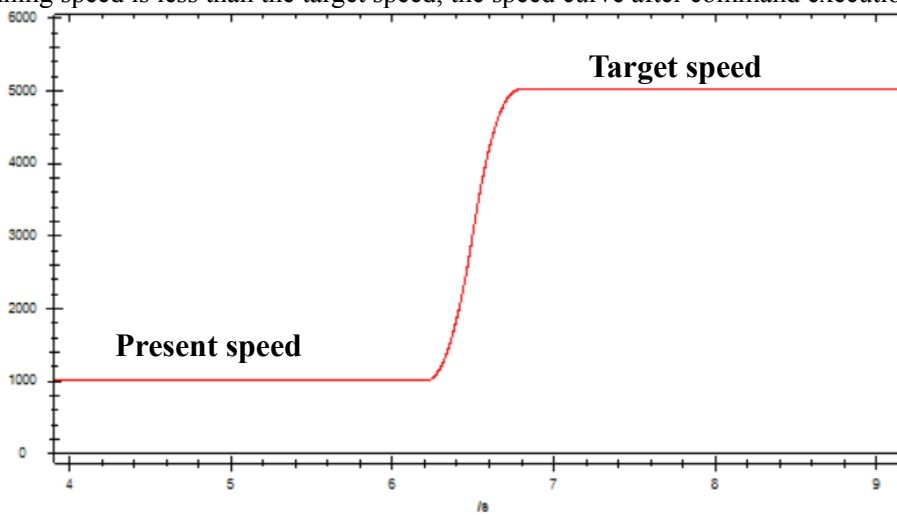

5-1-2-12. Superposition motion 【A_MOVESUP】

(1) Overview

Performs superimposed motion control on the specified axis.

Superposition motion [A MOVESUP]			
Execution condition	Rising/falling edge of the coil	Suitable model	XDH, XLH
Firmware	V3.7.1 and above	Software	3.7.4 and above

(2) Operand

Operand	Function	Type
S0	Input parameter start address	64-bit, four words
S1	Output state word start address	16-bit, single word
S2	Output state bit start address	Bit
S3	Axis output terminal number	16-bit, single word

(3) Suitable soft component

Operand	Word soft component								Bit soft component										
	System								Constant	Module		System							
	D*	FD	TD*	CD*	DX	DY	DM*	DS*	K/H	ID	QD	X	Y	M*	S*	T*	C*		
S0	●	●	●	●	●	●	●	●											
S1	●	●	●	●	●	●	●	●											
S2														●					
S3	●								●										

*: D means D, HD; TD means TD and HTD; CD means CD, HCD, HSCD and HSD; DM means DM and DHM; DS means DS and DHS; M means M, HM, SM; S means S, HS; T means T, HT; C means C, HC.

(4) Function and action



- S0 specifies input parameter start address
- S1 specifies output state word start address
- S2 specifies output state bit start address
- S3 specifies the axis terminal number
- When M0 changes from off to on, perform superimposed motion control on the designated axis of S3, with the distance of S0, the speed of S0 + 4, the acceleration of S0 + 8, the deceleration of S0 + 12 and the jerk speed of S0 + 16. When the command execution is completed, S2 is set to on.
- The command is triggered after the motion command and can be executed together with other motion commands to perform superimposed motion. The two command speeds will be superimposed. When the superimposed position is reached, the superimposed command is completed.
- When the instruction is executed separately, the effect is the same as that of A_MOVER.

(5) Notes

- The instruction can be interrupted by the latter instruction in interrupt mode, but cannot follow the buffer instruction
- The latter superposition instruction can interrupt the previous superposition instruction
- The superposition effect is only valid in the current motion, and will be invalid after the motion is completed.

(6) Related parameters

Input parameter	Parameter name	Data type	Unit	Note
S0	Distance	FP64	Command unit	Superposition distance

S0+4	Vel	FP64	Command unit /s	Superposition speed
S0+8	Acc	FP64	Command unit /s ²	Acceleration speed
S0+12	Dec	FP64	Command unit /s ²	Deceleration speed
S0+16	Jerk	FP64	Command unit /s ³	Jerk speed
Output parameter	Parameter name	Data type	Unit	Note
S1	ErrCode	INT16U	-	Command error code
State parameter	Parameter name	Data type	Unit	Note
S2	Done	BOOL	-	Instruction execution complete
S2+1	Busy	BOOL	-	The instruction is being executed
S2+2	Active	BOOL	-	Command under control
S2+3	Abort	BOOL	-	Instruction is interrupted
S2+4	Error	BOOL	-	Instruction execution error
Axis number	Parameter name	Data type	Unit	Note
S3	Axis	INT16U	-	Axis number starts from 0

Note: the relationship between acceleration/deceleration and jerk speed is same to A_MOVEA, please refer to chapter 5-1-2-7 item 5 for details.

(7) Sequence diagram

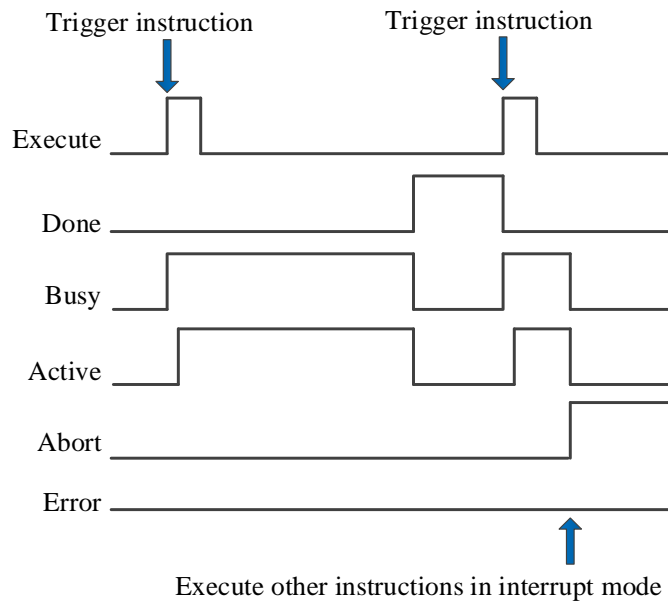

Explanation:

Generally, after the command is triggered, the Busy and Active signals are set, and reset after the command is executed. At the same time, the Done signal is set. Done will reset only after the command is triggered again, otherwise it will not reset automatically.

When a new instruction is triggered in interrupt mode during instruction execution, the Busy and Active signals are reset immediately and the Abort signal is set.

When there is an error in the command, the Error signal is set, other signals are reset, and the corresponding error code is output.

(8) Application

For example: the motor present position is 0, the motor moves to the position of 50000 at the speed of 5000 pulses/s, acceleration and deceleration of 2500 pulses/s², jerk speed of 50000 pulses/s³, and in the process, the

position is superimposed with 20000 at the speed of 5000 pulses/s, acceleration and deceleration of 10000 pulses/s², jerk speed of 20000 pulses/s³. The ladder diagram is shown in the following figure:

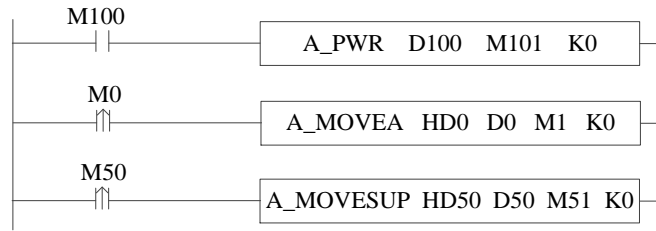

The command configuration is shown as below:

A_MOVEAInstruction parameter configuration ✕

Input parameter: Output parameter: Status parameter:

Effective axis num:

Name	Addr	Online value	Offline value	Data type	statement
Input parameter					
Pos	HD0	0	50000	FP64	Absolute target position
Vel	HD4	0	5000	FP64	The target velocity, u/s
Acc	HD8	0	25000	FP64	Acceleration, u/s ²
Dec	HD12	0	25000	FP64	Minus the velocity, u/s ²
Jerk	HD16	0	50000	FP64	Plus acceleration, u/s ³
ContinuousMode	HD20	Donotupdate	Donotupdate	INT16U	Continuously updated
Direction	HD21	Positivedirection	Positivedirection	INT16U	The direction of
BufferMode	HD22	interrupt	interrupt	INT16U	The caching pattern
Output parameter					
ErCode	D0	0		INT16U	Error code
Status parameter					
Done	M1	False		BIT	Completion status
Busy	M2	False		BIT	busy
Active	M3	False		BIT	active
Abort	M4	False		BIT	Interrupt status
Err	M5	False		BIT	Error status

space usage : ID0-HD22,D0-D0,M1-M5, Write Ok Cancel

A_MOVESUPInstruction parameter configuration ✕

Input parameter: Output parameter: Status parameter:

Effective axis num:

Name	Addr	Online value	Offline value	Data type	statement
Input parameter					
Distance	HD50	0	20000	FP64	Superposition of distance
Vel	HD54	0	5000	FP64	The stacking velocity, u/s
Acc	HD58	0	10000	FP64	Acceleration, u/s ²
Dec	HD62	0	10000	FP64	Minus the velocity, u/s ²
Jerk	HD66	0	20000	FP64	Plus acceleration, u/s ³
Output parameter					
ErCode	D50	0		INT16U	Error code
Status parameter					
Done	M51	False		BIT	Completion status
Busy	M52	False		BIT	busy
Active	M53	False		BIT	active
Abort	M54	False		BIT	Interrupt status
Err	M55	False		BIT	Error status

space usage : ID50-HD69,D50-D50,M51-M55, Write Ok Cancel

Explanation:

To enable the axis through A_PWR instruction. After confirming that the axis is enabled, turn M0 from off → on to trigger A_MOVEA command, the axis will move to 50000 with the set parameters. During the axis movement, M50 will be turned from off → on to trigger A_MOVESUP command, the axis will perform superposition motion with the set parameters.

The position curve is shown as below:

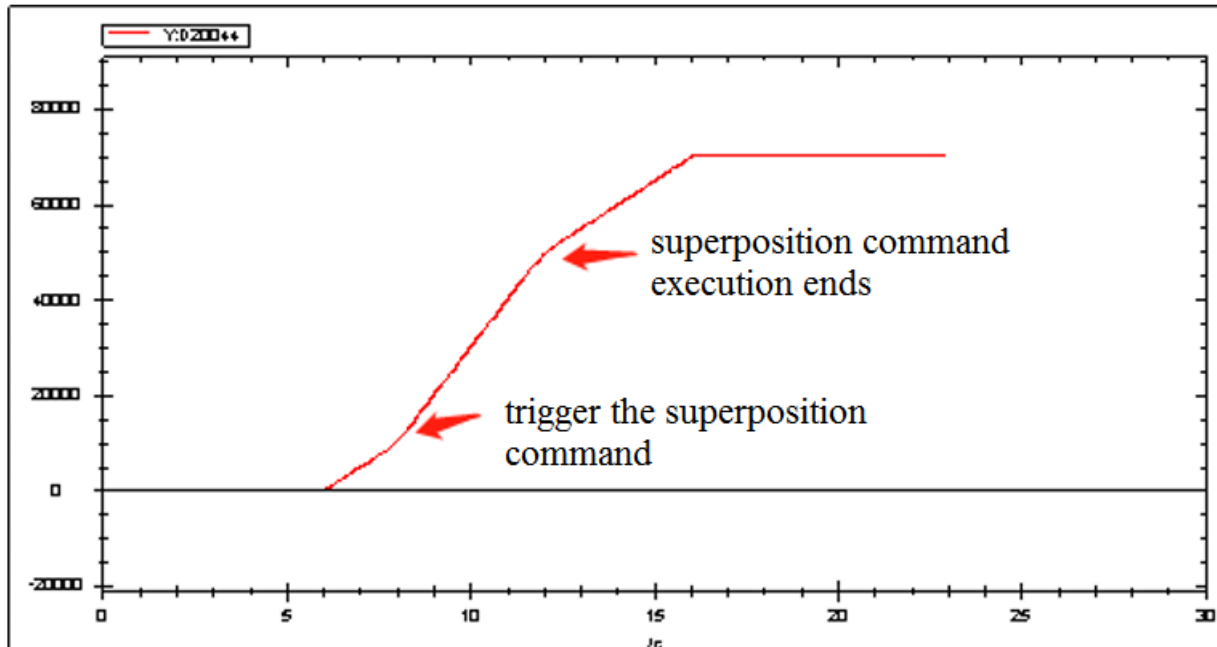

The speed curve is shown as below:

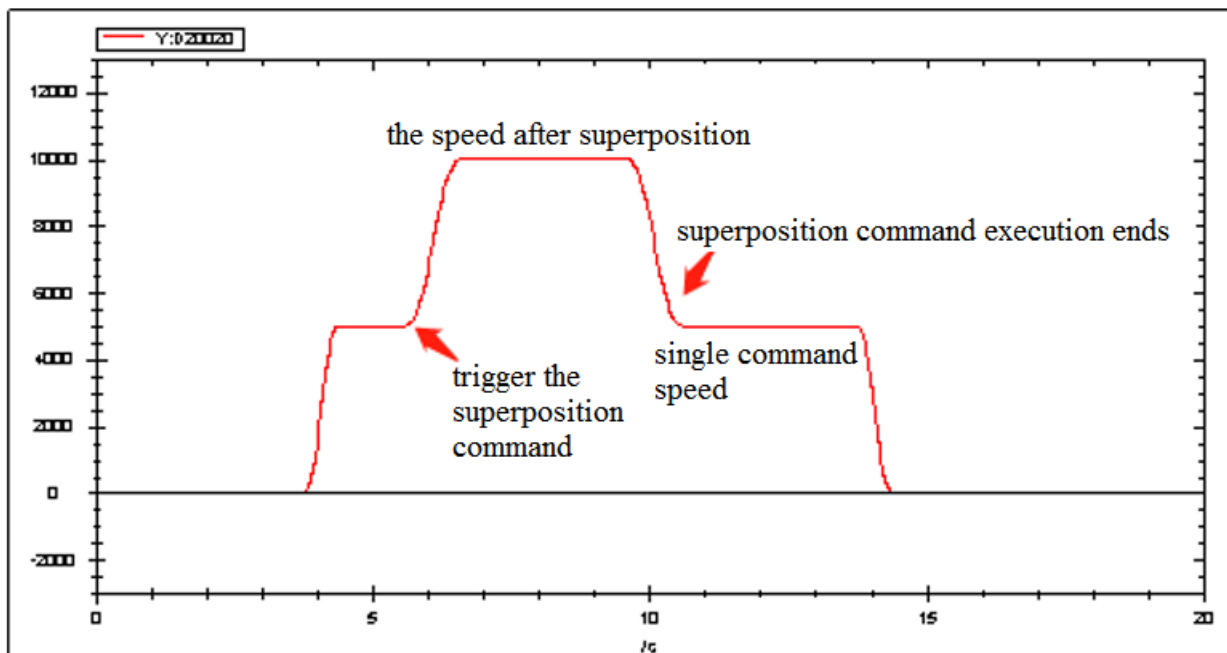

Explanation:

In the process of axis movement, the superposition command is triggered, the two commands will be executed together, and the speed will be superimposed. After the superposition command is executed for the distance to be superimposed, the speed will be reduced to the speed set by the previous motion command, and the motion command will continue to be executed.

5-1-2-13. HM homing 【A_HOME】

(1) Overview

Return to the origin for the specified axis, this command requires that the specified axis support the HM mode of the Ethernet bus.

HM homing [A_HOME]			
Execution condition	Rising/falling edge of the coil	Suitable model	XDH, XLH
Firmware	V3.6.1b and above	Software	3.7.4 and above

(2) Operand

Operand	Function	Type
S0	Input parameter start address	64-bit, four words
S1	Output state word start address	16-bit, single word
S2	Output state bit start address	Bit
S3	Axis output terminal number	16-bit, single word

(3) Suitable soft component

Operand	Word soft component								Bit soft component									
	System								Constant	Module	System							
	D*	FD	TD*	CD*	DX	DY	DM*	DS*	K/H	ID	QD	X	Y	M*	S*	T*	C*	
S0	●	●	●	●	●	●	●	●										
S1	●	●	●	●	●	●	●	●										
S2														●				
S3	●								●									

*: D means D, HD; TD means TD and HTD; CD means CD, HCD, HSCD and HSD; DM means DM and DHM; DS means DS and DHS; M means M, HM, SM; S means S, HS; T means T, HT; C means C, HC.

(4) Function and action



- S0 specifies input parameter start address, occupies the register S0~S0+4
- S1 specifies output state word start address
- S2 specifies output state bit start address, occupies the relay S2~S2+4
- S3 specifies the axis terminal number, only for EtherCAT axis
- When M0 is from OFF→ON, return the axis corresponding to S3 to the original point. After returning to the original point, S0 will be written to the current position (D20044+200*N) (N is axis number, which starts from 0)
- When using the home command, it is necessary to set the homing mode (6098h), homing speed (6099h) and homing acceleration (609Ah) of the specified axis in advance. For the selection of homing mode, refer to the EtherCAT motion control user manual
- When the command is executed, it will automatically switch the specified axis to HM mode (6060h is 6), and it will switch back to the original mode after returning to the origin. If the process of returning to the origin is abnormal, it will remain in HM mode and need to switch to CSP mode (6060h is 8) through A_MODE to execute other commands
- A_STOP can be used to stop the motion during instruction execution, trigger the command again to continue to return to the origin
- After the command is executed, the single axis state of the slave station (D20000+200*N) switches to 5

(5) Related parameters

Input parameter	Parameter name	Data type	Unit	Note
S0	Offset	FP64	Command unit	Zero offset. That is, write the value of the current position after returning to the origin

S0+4	BufferMode	INT16U	-	Buffer mode 0: interrupt mode 1: buffer mode
Output parameter	Parameter name	Data type	Unit	Note
S1	ErrCode	INT16U	-	Command error code
State parameter	Parameter name	Data type	Unit	Note
S2	Done	BOOL	-	Instruction execution complete
S2+1	Busy	BOOL	-	The instruction is being executed
S2+2	Active	BOOL	-	Command under control
S2+3	Abort	BOOL	-	Instruction is interrupted
S2+4	Error	BOOL	-	Instruction execution error
Axis number	Parameter name	Data type	Unit	Note
S3	Axis	INT16U	-	Axis number starts from 0

(6) Sequence diagram

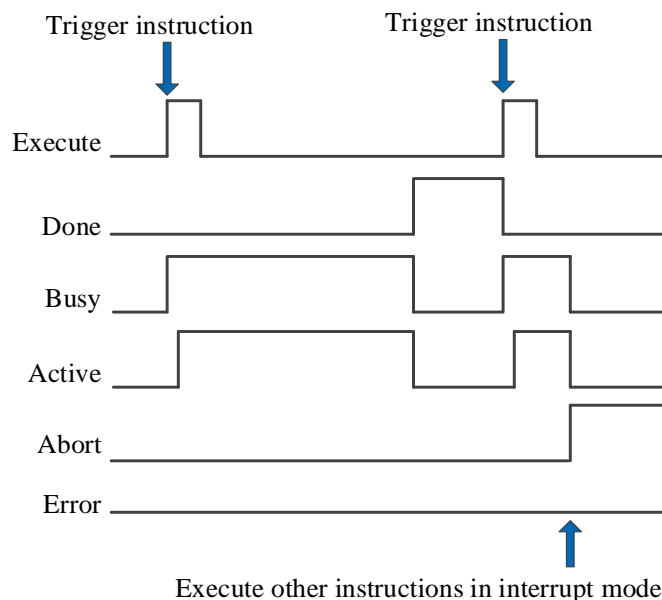

Explanation:

Generally, after the command is triggered, the Busy and Active signals are set, and reset after the command is executed. At the same time, the Done signal is set. Done will reset only after the command is triggered again, otherwise it will not reset automatically.

When the instruction is triggered in the buffer mode and there are currently instructions being executed, the Active signal will be set immediately. The execution of the current instruction ends. When the instruction is executed, the Busy signal will be set. After the execution of the instruction ends, the Busy and Active signals will be reset and the Done signal will be set.

When a new instruction is triggered in interrupt mode during instruction execution, the Busy and Active signals are reset immediately and the Abort signal is set.

When there is an error in the command, the Error signal is set, other signals are reset, and the corresponding error code is output.

(7) Application

For example, the specified axis is required to return to the origin in mode 1. The ladder diagram is as follows:

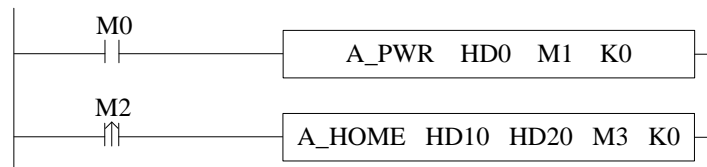

The command configuration is shown as below:

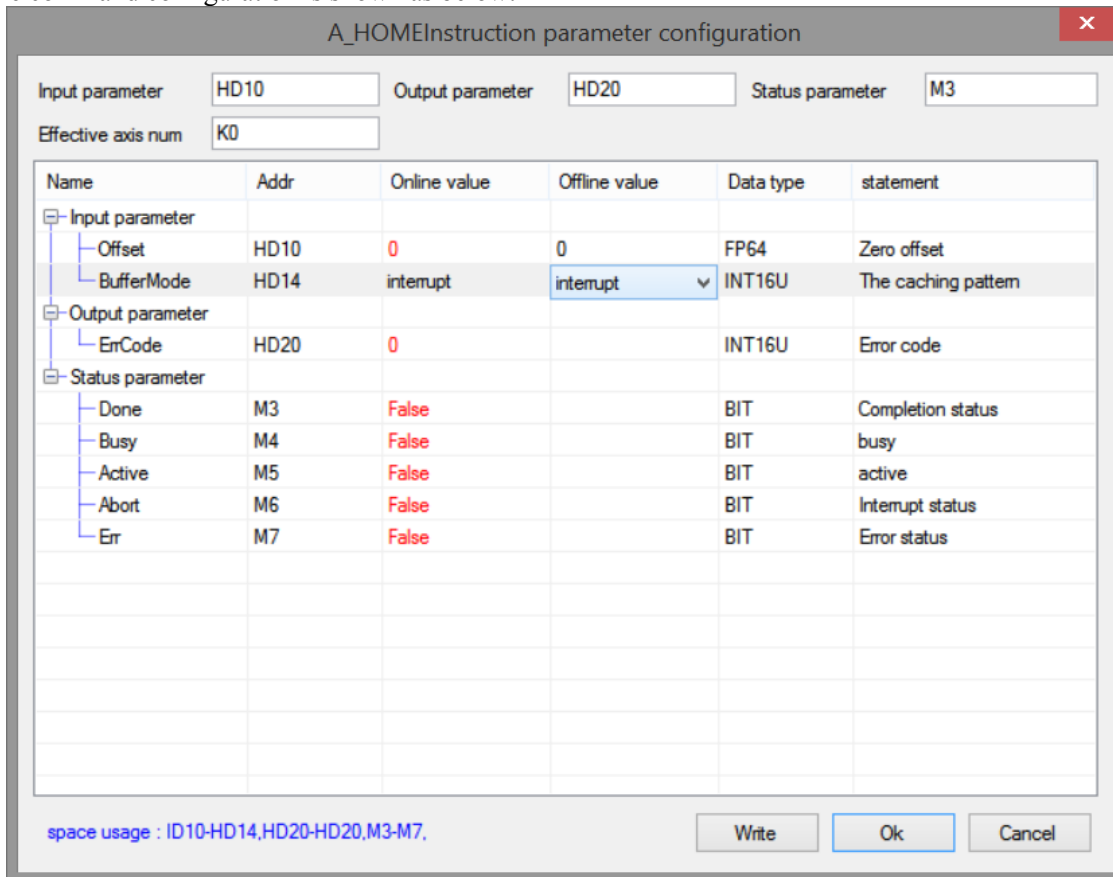

Explanation:

Before the A_HOME command is executed, it is necessary to set the home mode (6098h) to 1, modify the home speed (6099h) as required, and modify the home acceleration (609Ah) as required. Refer to item (7) home mode (6098h) for details.

The home mode can be set through COE-Online interface or modify 6098h through SDO instruction (refer to chapter 10 for SDO instruction). After the command runs, the specified axis will automatically switch the control mode (6060h) to HM mode and return to the origin. The origin signal is set by the slave station. Take DS5C as an example, P5-22 is the positive limit setting address, and the default value is 1, that is, the corresponding servo terminal SI1, P5-23 is the negative limit setting address, and the default value is 2, that is, the corresponding servo terminal SI2, P5-27 sets the address for the origin, and the default value is 3, that is, the corresponding servo terminal SI3. Whether to trigger the origin or the positive and negative limit is determined by the mode of returning to the origin. After returning to the origin, the axis will automatically switch to the mode before returning to the origin, and write the zero offset value (0 in this example) in the command to the current position D20044+200*N.

The COE-Online interface is opened as follows:

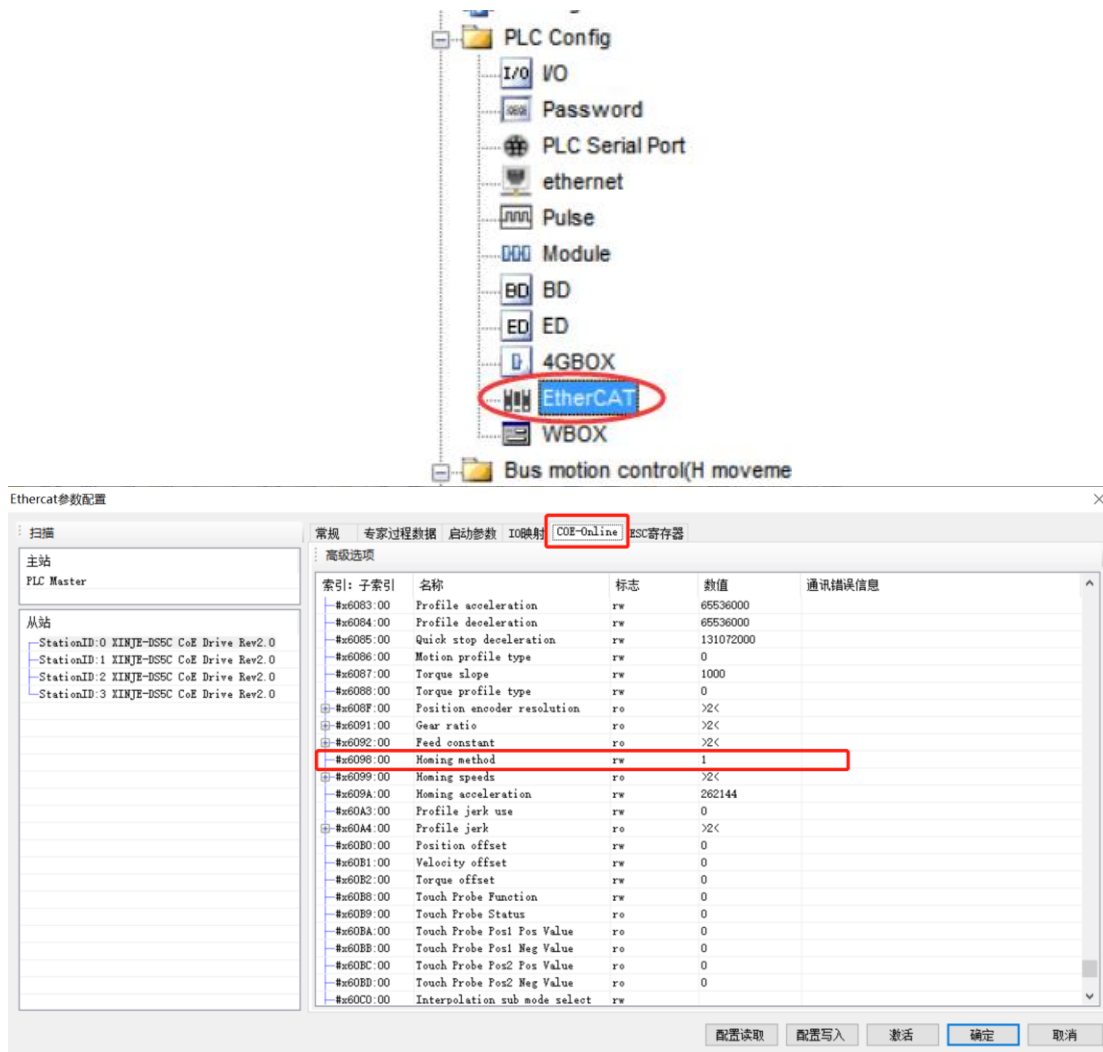

■ Mode 1:

When using mode 1, if the reverse limit switch is in the non triggered state, the initial moving direction is left. The origin position is at the first Z-phase pulse on the right of the position where the negative limit switch becomes invalid.

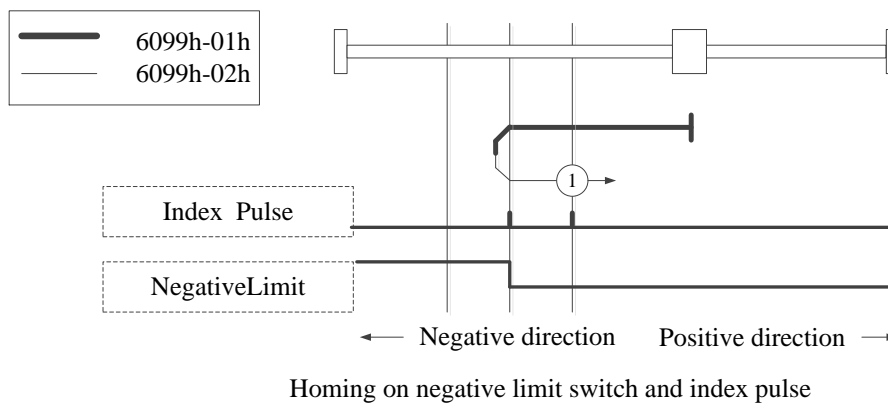

■ Mode 2:

When using mode 2, if the positive limit switch is in the non triggered state, the initial moving direction is right. The origin position is at the first Z-phase pulse on the left of the position where the positive limit switch becomes invalid.

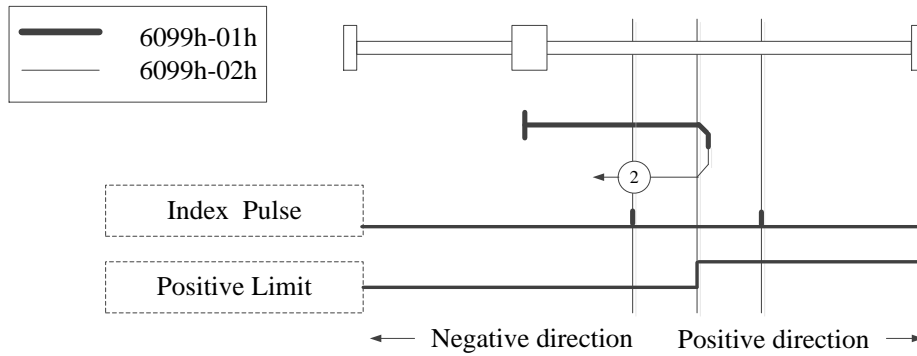

Homing on positive limit switch and index pulse

■ Mode 3, 4:

When using mode 3 or 4, the initial direction of movement depends on the state of the origin switch. The origin position is on the reverse side of the origin switch or on the initially detected Z-phase position in the forward direction.

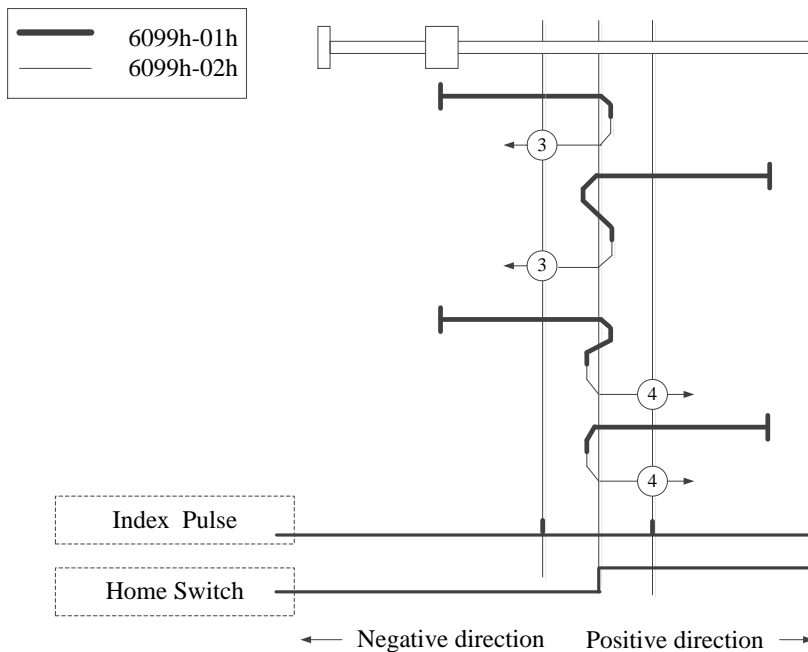

Homing on positive home switch and index pulse

■ Mode 5, 6:

When using mode 5 or 6, the initial direction of movement depends on the state of the origin switch. The origin position is on the reverse side of the origin switch or on the initially detected Z-phase position in the forward direction.

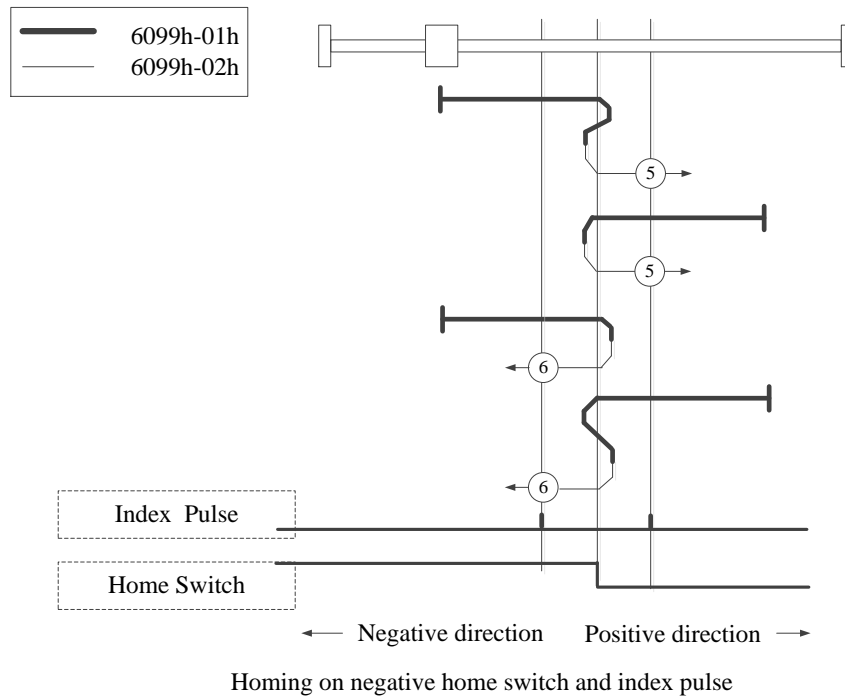

■ Mode 7~14:

Mode 7-14 all use origin switch and Z-phase signal;

The initial action direction of modes 7 and 8 is negative if the origin switch has been activated at the beginning of action.

The initialization action direction of modes 9 and 10 is positive if the origin switch has been activated at the beginning of the action.

The initialization action direction of modes 11 and 12 is the positive direction if the origin switch has been activated at the beginning of the action.

The initialization action direction of modes 13 and 14 is the negative direction if the origin switch has been activated at the beginning of the action.

The home position finally returning to is the Z-phase signal near the rising or falling edge of the origin switch.

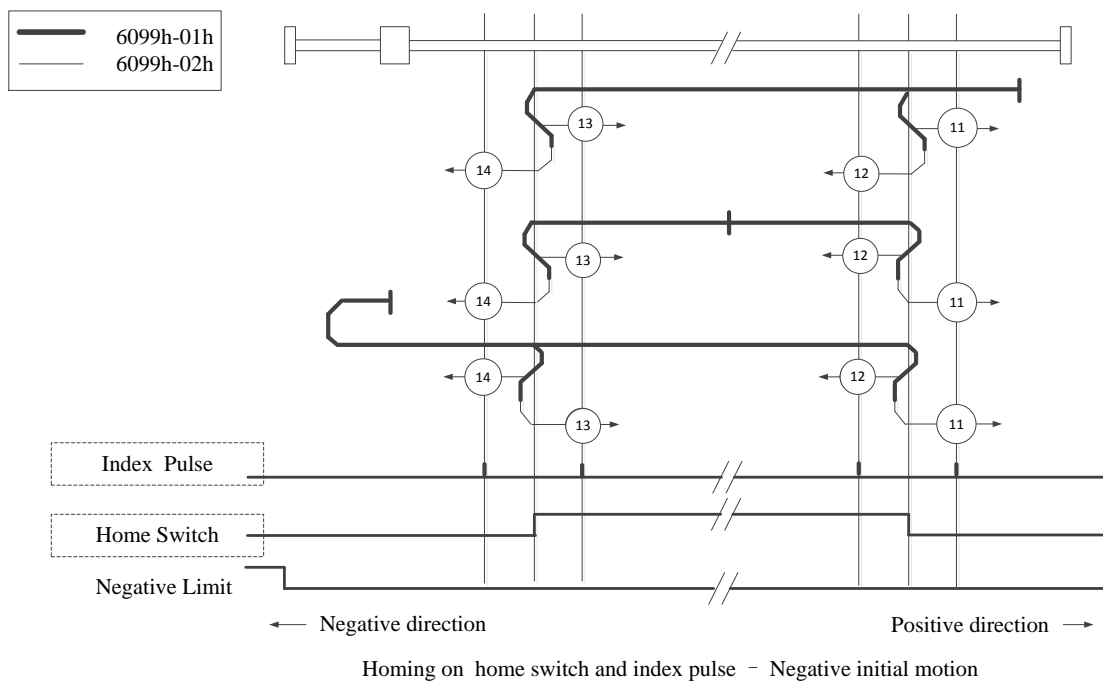
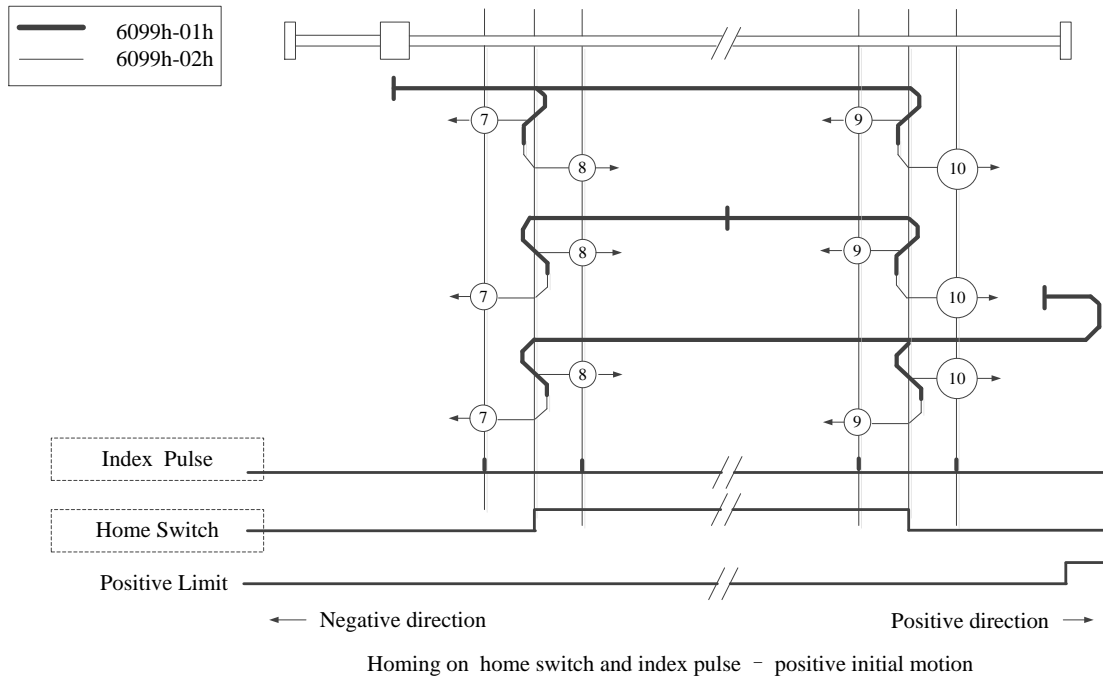

■ Mode 17:

This mode is similar to mode 1.

The difference is that the origin point detection position is not Index pulse but the position where Limit switch changed. (see below diagram)

When NOT is not distributed, Homing error = 1.

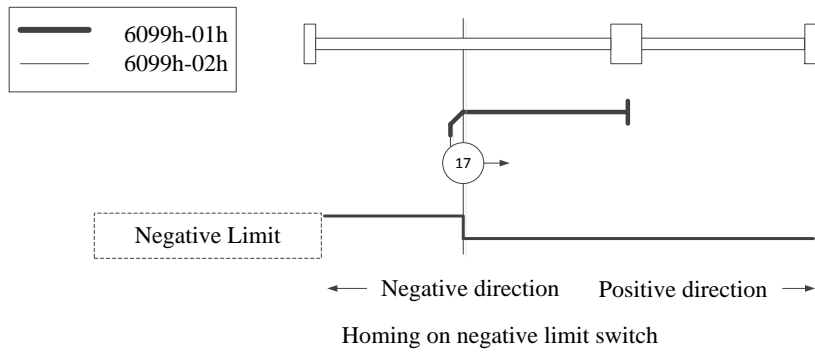

■ Mode 18:

This mode is similar to mode 2.

The difference is that the origin point detection position is not Index pulse but the position where Limit switch changed. (see below diagram)

When POT is not distributed, Homing error = 1.

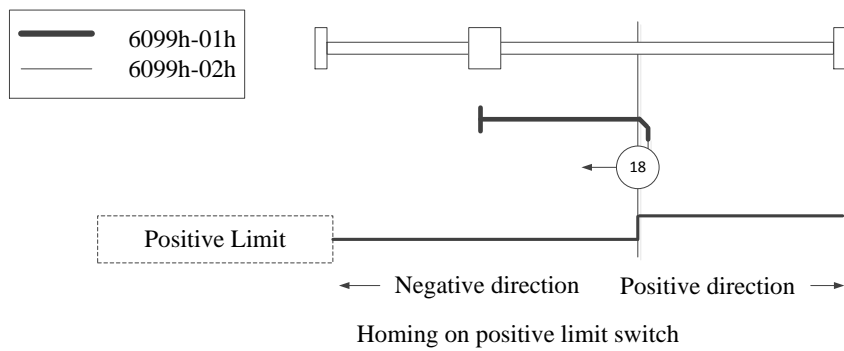

■ Mode 19, 20:

This mode is similar to mode 3, 4.

The difference is that the origin point detection position is not Index pulse but the position where Home switch changed. (see below diagram)

When HOME is not distributed, Homing error = 1.

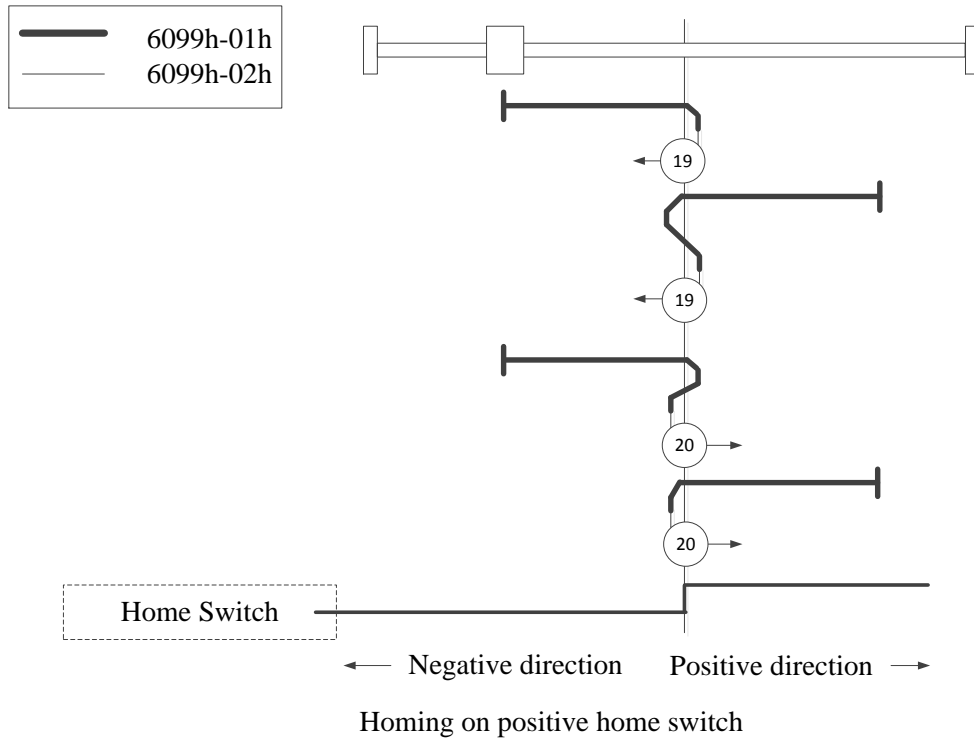

■ Mode 21, 22:

This mode is similar to mode 5, 6.

The difference is that the origin point detection position is not Index pulse but the position where Home switch changed. (see below diagram)

When HOME is not distributed, Homing error = 1.

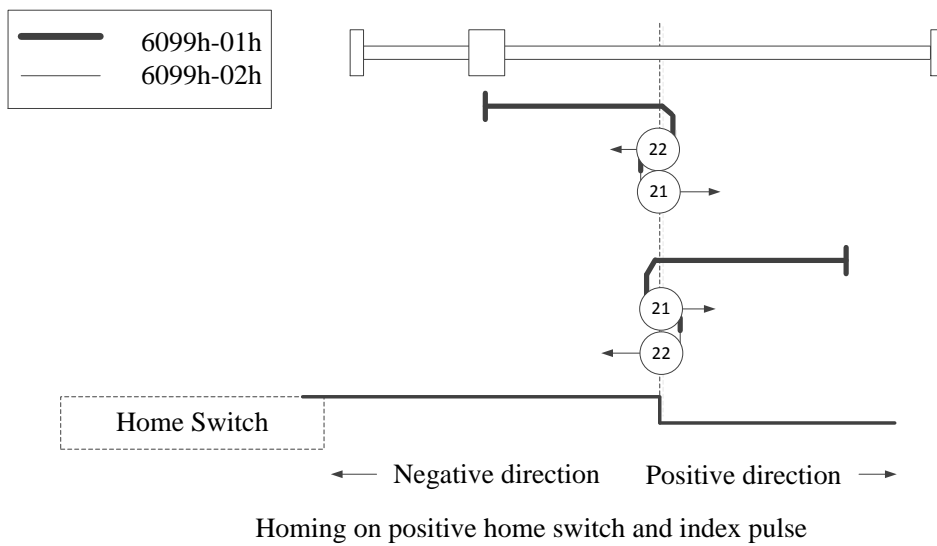

■ Mode 23, 24, 25, 26:

This mode is similar to mode 7, 8, 9, 10.

The difference is that the origin point detection position is not Index pulse but the position where Home switch changed. (see below diagram)

When HOME, POT are not distributed, Homing error = 1.

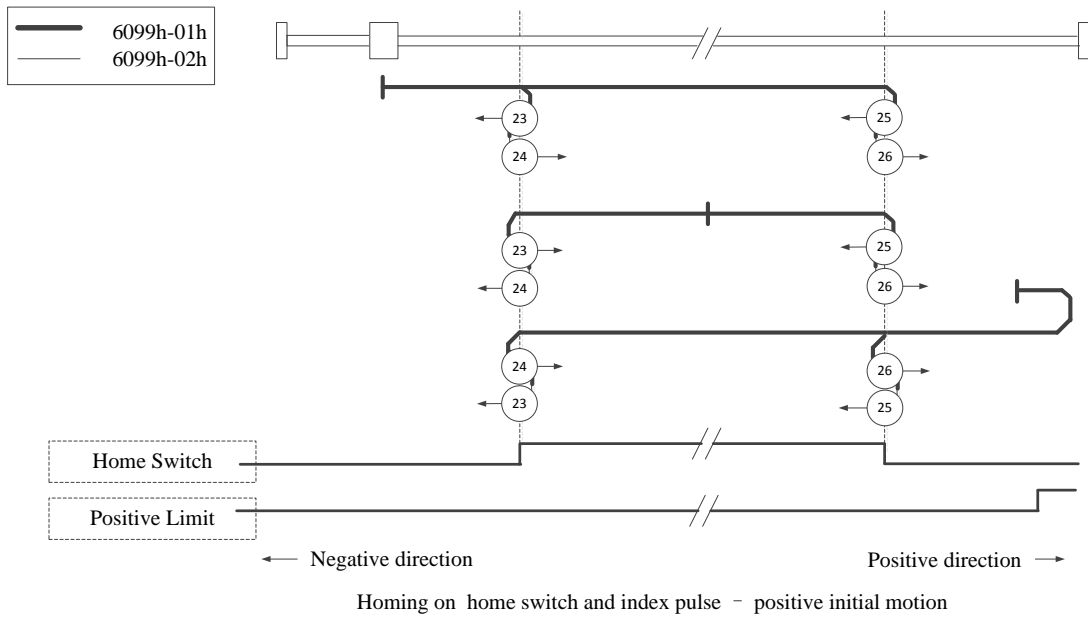

■ Mode 27, 28, 29, 30:

This mode is similar to mode 11, 12, 13, 14.

The difference is that the origin point detection position is not Index pulse but the position where Home switch changed. (see below diagram)

When HOME, NOT are not distributed, Homing error = 1.

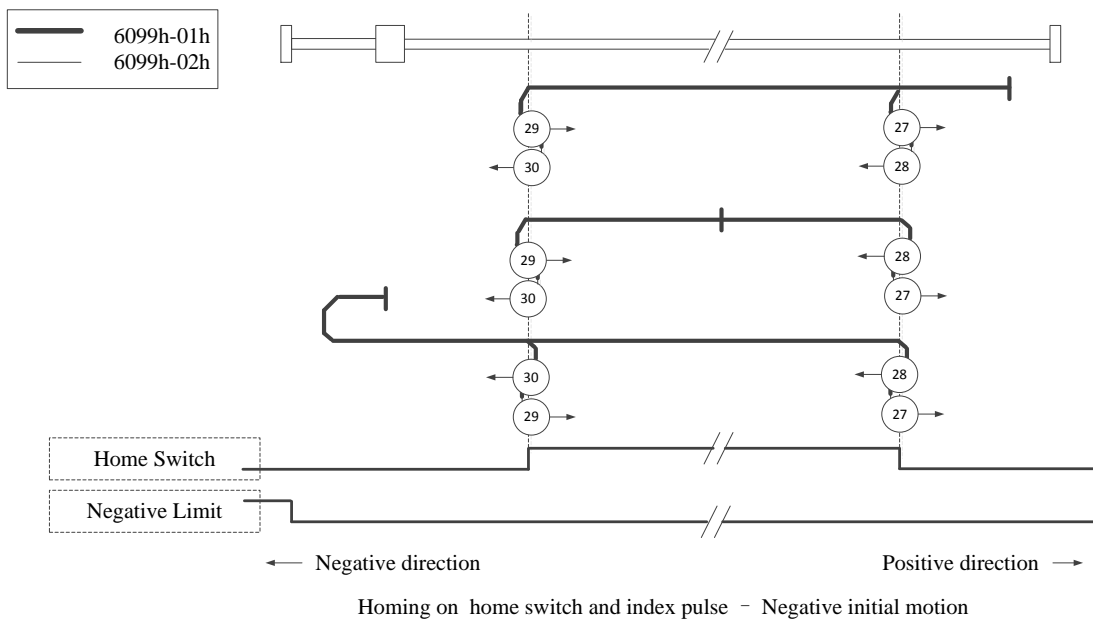

■ Mode 33, 34:

When using mode 33 or 34, the homing direction is negative or positive values, respectively. The original position is at the Z-phase near the setting direction.

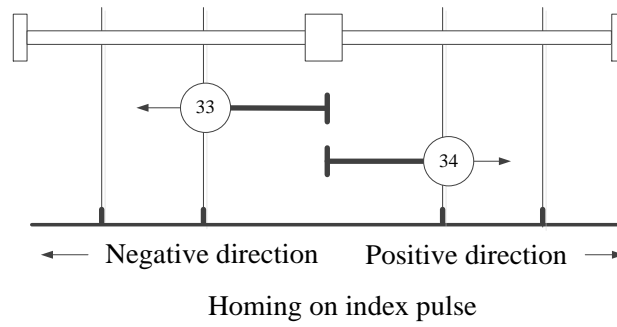
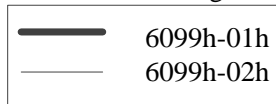

■ Mode 35, 37:

In modes 35 and 37, the position after power on is the origin position.

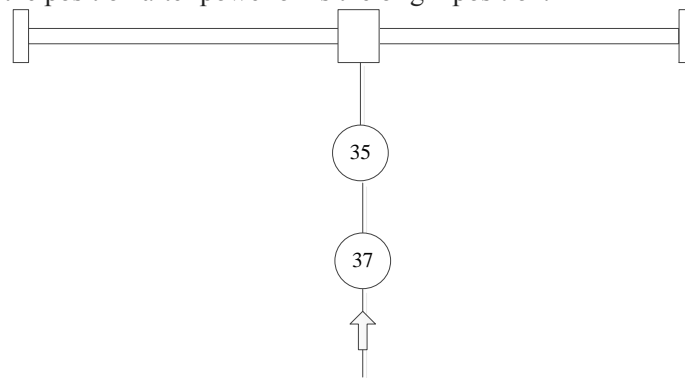

5-1-2-14. Homing 【A_ZRN】

(1) Overview

Master station homing command.

Homing [A_ZRN]			
Execution condition	Rising/falling edge of the coil	Suitable model	XDH, XLH
Firmware	V3.7.1 and above	Software	3.7.4 and above

(2) Operand

Operand	Function	Type
S0	Output state word start address	16-bit, single word
S1	Output state bit start address	Bit
S2	Axis output terminal number	16-bit, single word

(3) Suitable soft component

Operand	Word soft component											Bit soft component					
	System								Constant	Module		System					
	D*	FD	TD*	CD*	DX	DY	DM*	DS*	K/H	ID	QD	X	Y	M*	S*	T*	C*
S0	●	●	●	●	●	●	●	●									
S1	●	●	●	●	●	●	●	●									
S2														●			
S3	●								●								

*: D means D, HD; TD means TD and HTD; CD means CD, HCD, HSCD and HSD; DM means DM and DHM; DS means DS and DHS; M means M, HM, SM; S means S, HS; T means T, HT; C means C, HC.

(4) Function and action

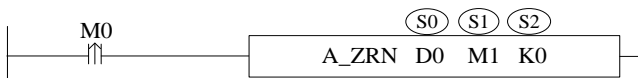

- S1 specifies output state bit start address
- S2 specifies the axis output terminal number, occupies the relay S3~S3+1
- Trigger the command, S2 specified axis starts to return to zero at the configured speed, acceleration and jerk speed, and the parameter S1 is set after the return to zero is completed.
- Other motion commands cannot be executed during the homing process, and the homing command cannot be executed during the axis motion.

(5) Notes

- Before using, please set the positive/negative hard limit port in axis configuration, and related parameters of homing configuration.
- See (8) for the specific way of returning to the origin.

(6) Related parameters

Output parameter	Parameter name	Data type	Unit	Note
S0	ErrCode	INT16U	-	Command error code
State parameter	Parameter name	Data type	Unit	Note
S1	Done	BOOL	-	Instruction execution complete
S1+1	Busy	BOOL	-	The instruction is being executed
S1+2	Active	BOOL	-	Command under control
S1+3	Abort	BOOL	-	Instruction is interrupted
S1+4	Error	BOOL	-	Instruction execution error
Axis	Parameter name	Data type	Unit	Note

number	Axis	INT16U	-	Axis number starts from 0
S2	Axis	INT16U	-	Axis number starts from 0

(7) Sequence diagram

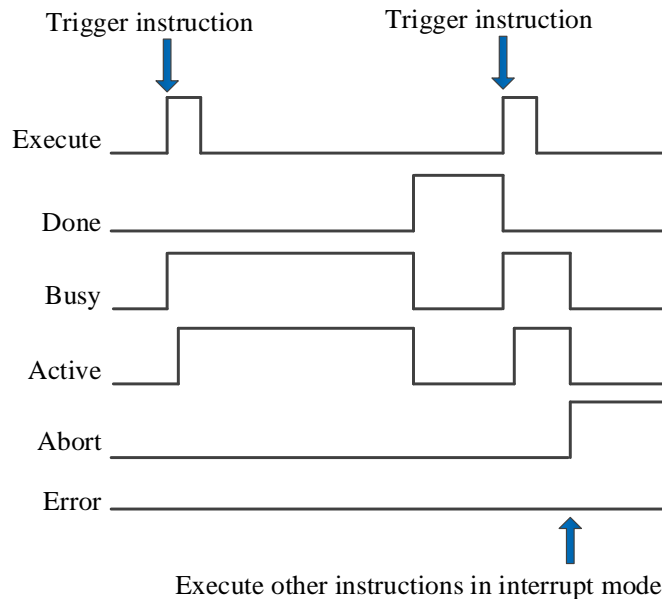

Explanation:

Generally, after the command is triggered, the Busy and Active signals are set, and reset after the command is executed. At the same time, the Done signal is set. Done will reset only after the command is triggered again, otherwise it will not reset automatically.

When a new instruction is triggered in interrupt mode during instruction execution, the Busy and Active signals are reset immediately and the Abort signal is set.

When there is an error in the command, the Error signal is set, other signals are reset, and the corresponding error code is output.

(8) Application

It is required to return to the origin of the specified axis, and the ladder diagram is as follows:

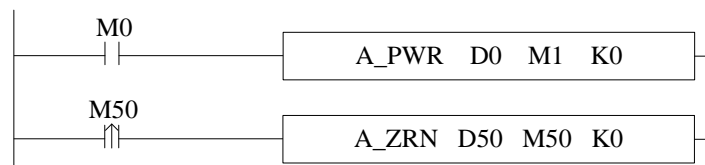

Parameter configurations:

■ Positive/negative hard limit port configuration: (axis configuration--- limit configuration)

<input type="checkbox"/>	Hard limit stop...	SFD8040	suspension	suspension	ENUM	Power back on
<input type="checkbox"/>	Positive hard l...	SFD8041	7	7	INT16U	Power back on
<input type="checkbox"/>	Positive hard l...	SFD8042	Polarity nonreve...	Polarity nonreve...	ENUM	Power back on
<input type="checkbox"/>	Negative hard...	SFD8043	11	11	INT16U	Power back on
<input type="checkbox"/>	Negative hard...	SFD8044	Polarity nonreve...	Polarity nonreve...	ENUM	Power back on

■ Homing parameter configuration (axis configuration- homing configuration)

<input type="checkbox"/>	The origin port	SFD8160	13	13	INT16U
<input type="checkbox"/>	Origin port pol...	SFD8161	Polarity nonreve...	Polarity nonreve...	ENUM
<input type="checkbox"/>	Near point port	SFD8162	177777	177777	INT16U
<input type="checkbox"/>	Near point por...	SFD8163	Polarity nonreve...	Polarity nonreve...	ENUM
<input type="checkbox"/>	Z in port	SFD8164	177777	177777	INT16U
<input type="checkbox"/>	Z phase port ...	SFD8165	Polarity nonreve...	Polarity nonreve...	ENUM
<input type="checkbox"/>	Z is the numb...	SFD8166	0	0	INT16U
<input type="checkbox"/>	Back to zero ...	SFD8168	5000	5000	FP64
<input type="checkbox"/>	Return to zer...	SFD8172	1000	1000	FP64
<input type="checkbox"/>	Return to zer...	SFD8176	5000	5000	FP64
<input type="checkbox"/>	Back to zero ...	SFD8180	5000	5000	FP64
<input type="checkbox"/>	Back to zero ...	SFD8184	5000	5000	FP64
<input type="checkbox"/>	zero position	SFD8188	10	10	FP64
<input type="checkbox"/>	Back to zero ...	SFD8192	forward direction	forward direction	ENUM

Note: input ports, speed parameters and other parameters must be configured before using the command, and the polarity of near point port and near point port is not supported temporarily.

The way to return to zero is different from the starting position, and the way to return to the origin is different:

◆ No Z-phase signal

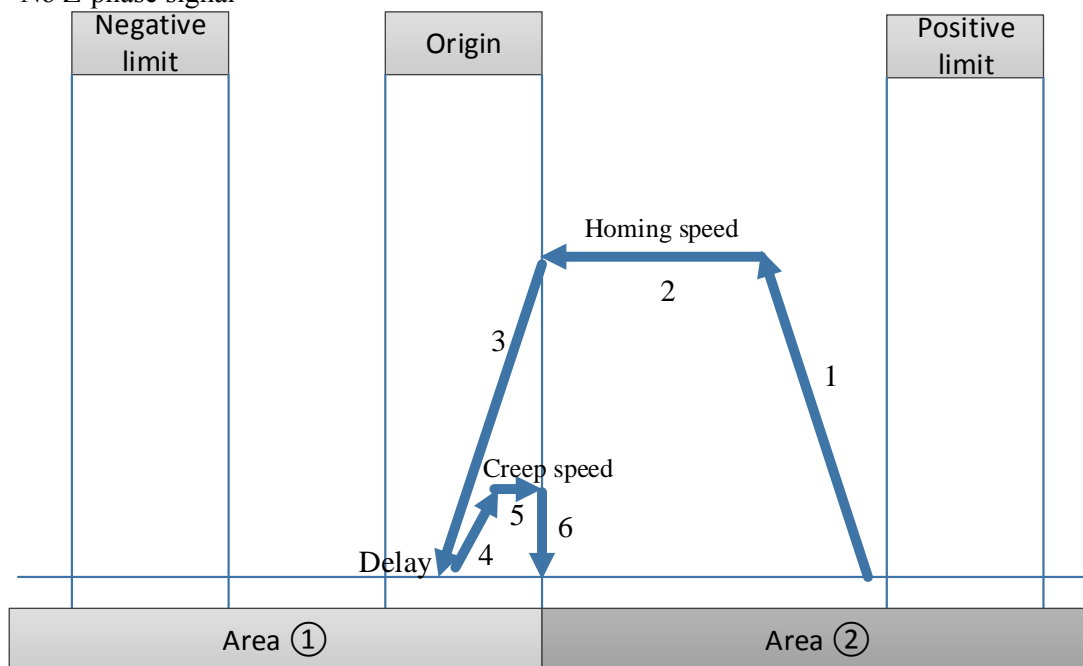

◆ With Z-phase signal

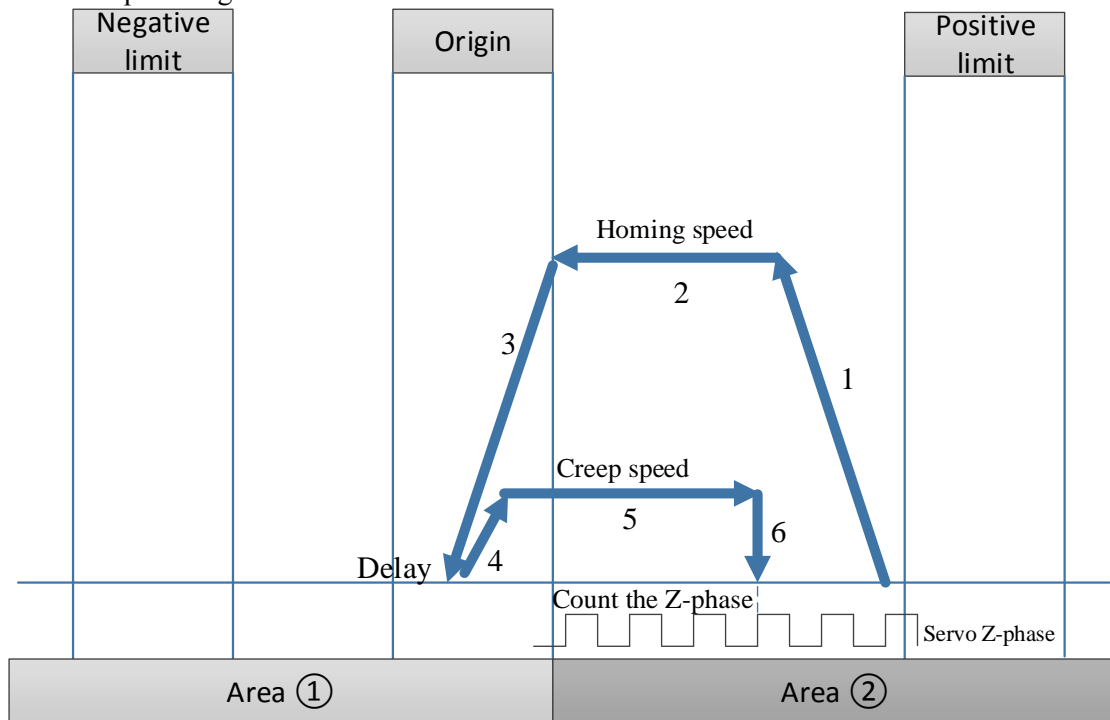

◆ Origin signal is not limit signal

➤ Start position is between origin and positive limit

(1) Homing direction: negative

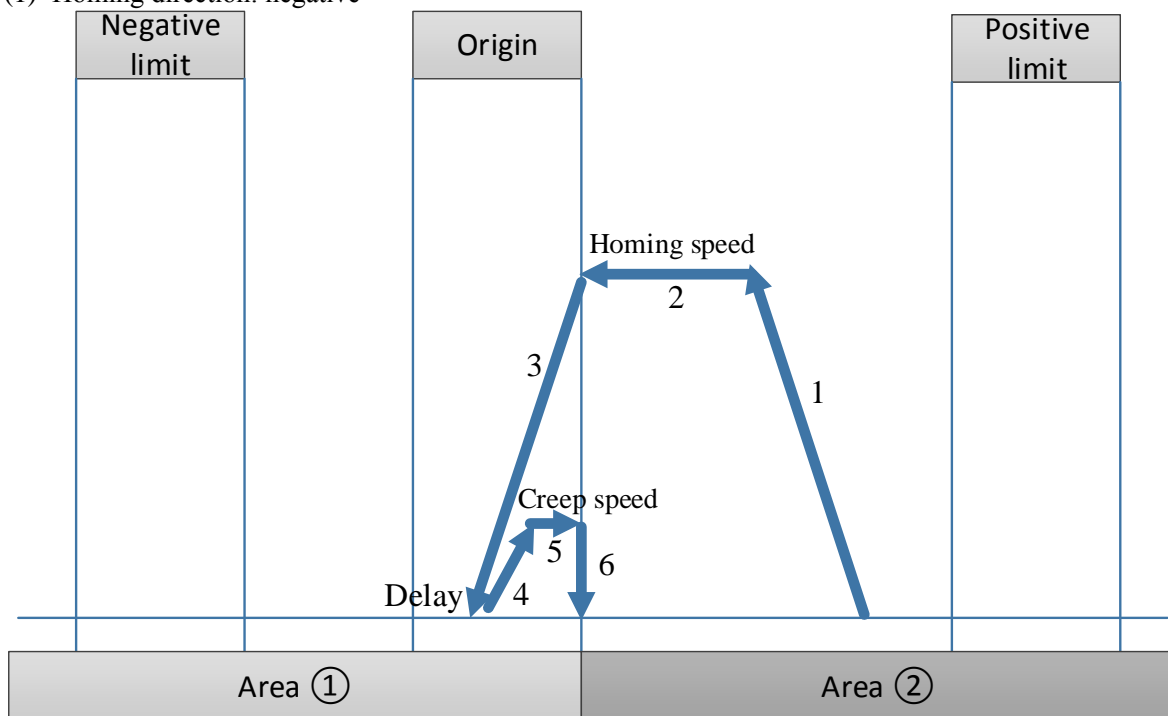

Homing in reverse direction

(2) Homing direction: positive

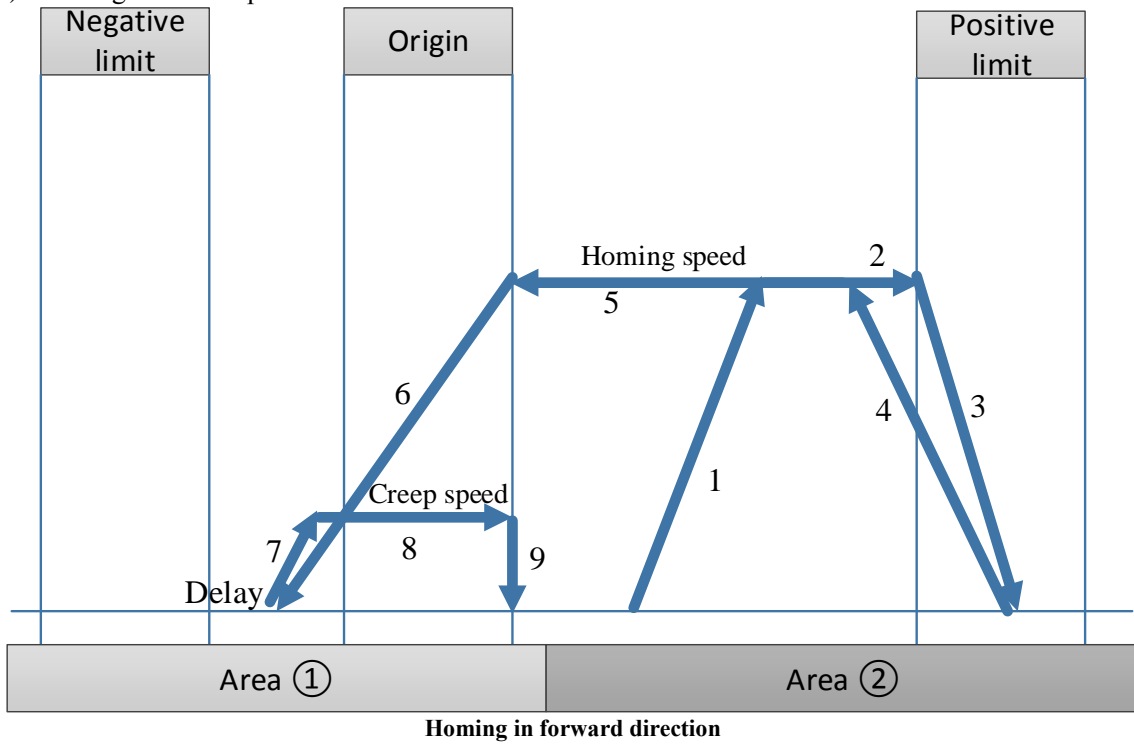

➤ **Start position is at the positive limit**

(1) Homing direction: negative

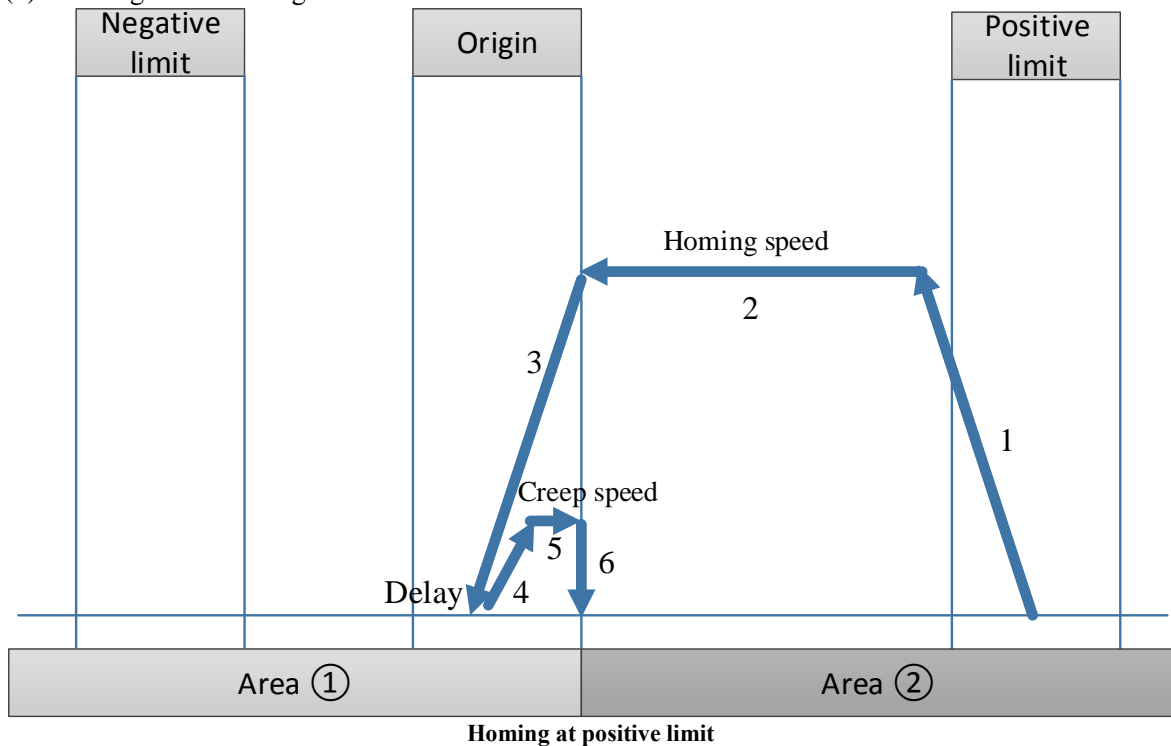

(2) Homing direction: positive

Command error: homing direction configuration error, cannot homing.

➤ **Start position over the hard limit**

When the starting position of the worktable exceeds the positive limit, in order to prevent the collision accident caused by the positive homing, do not perform the homing operation under this condition. The worktable must be manually moved back between the positive and negative limits before the homing operation.

➤ **Start position is between origin and negative limit**

(1) Homing direction: negative

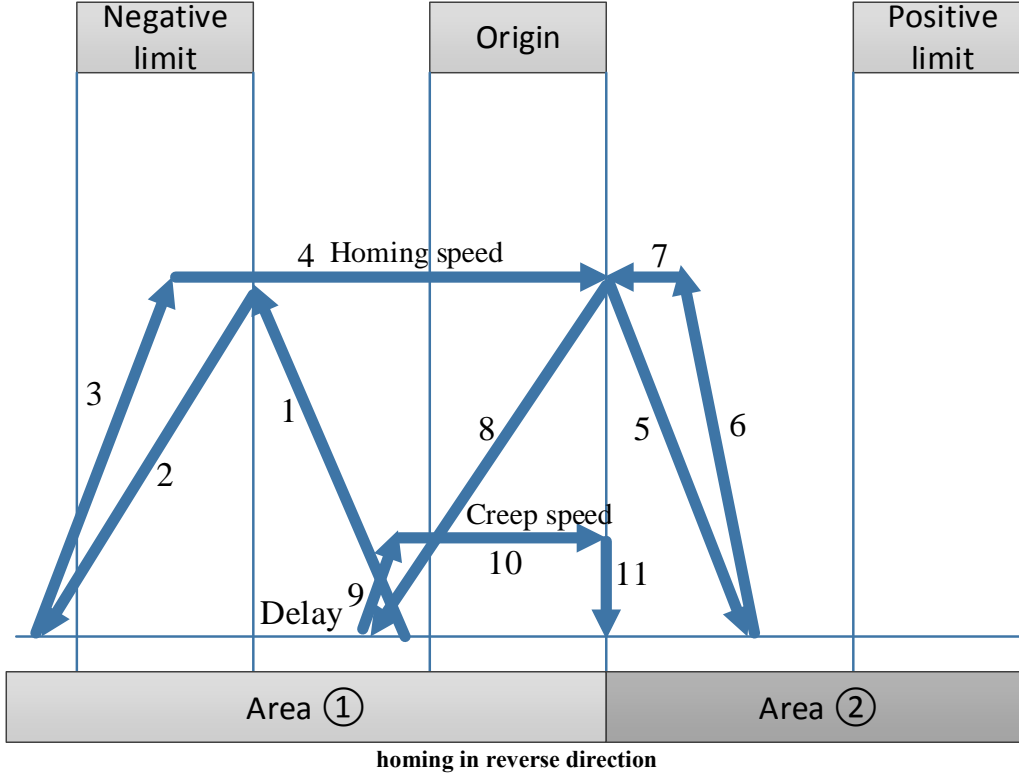

(2) Homing direction: positive

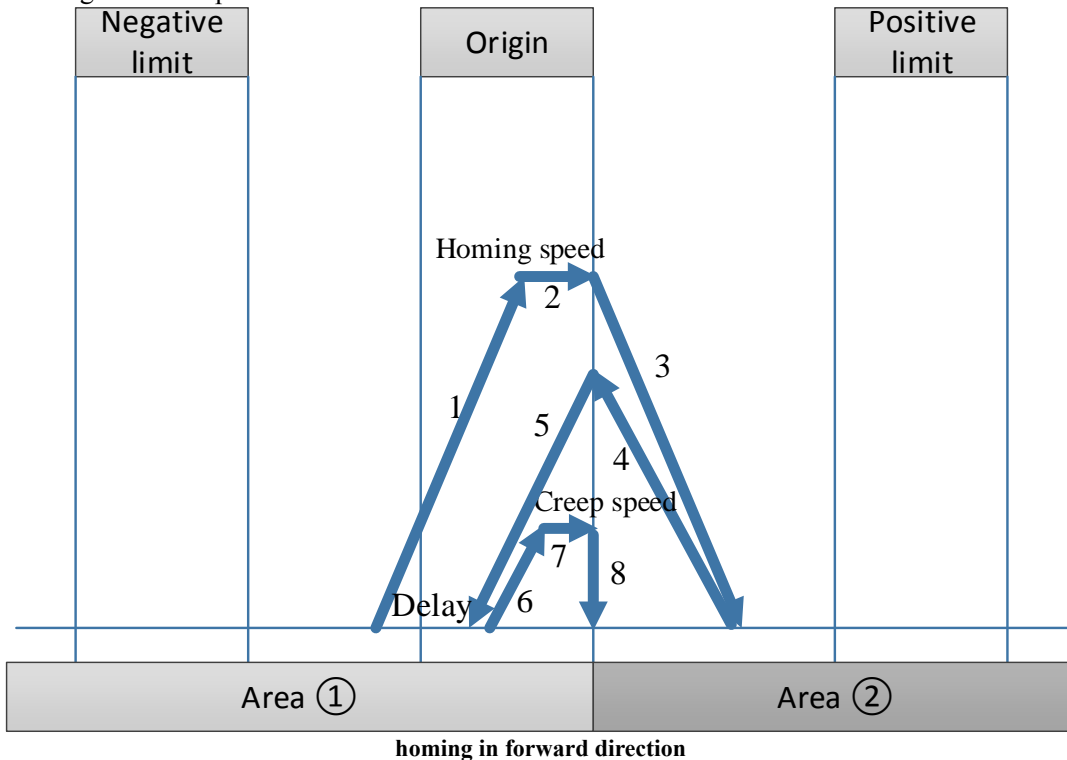

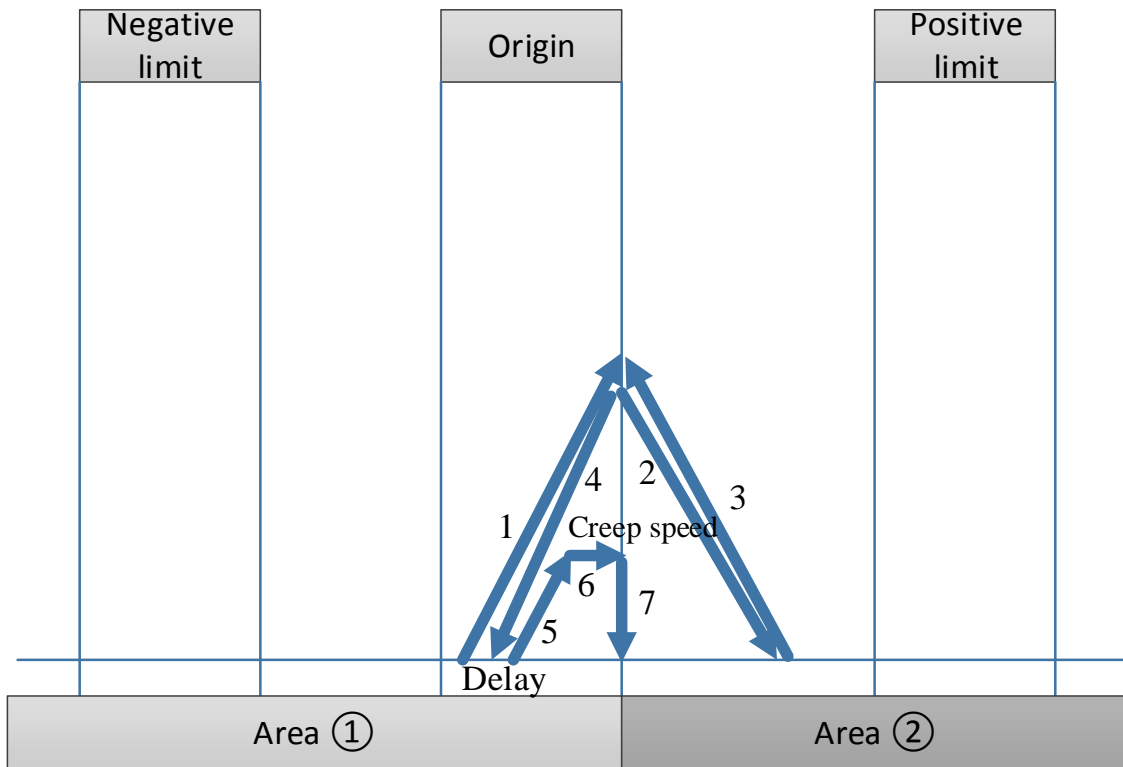

◆ Origin signal is limit signal

➤ Start position is between positive limit and negative limit

(1) Homing direction: negative

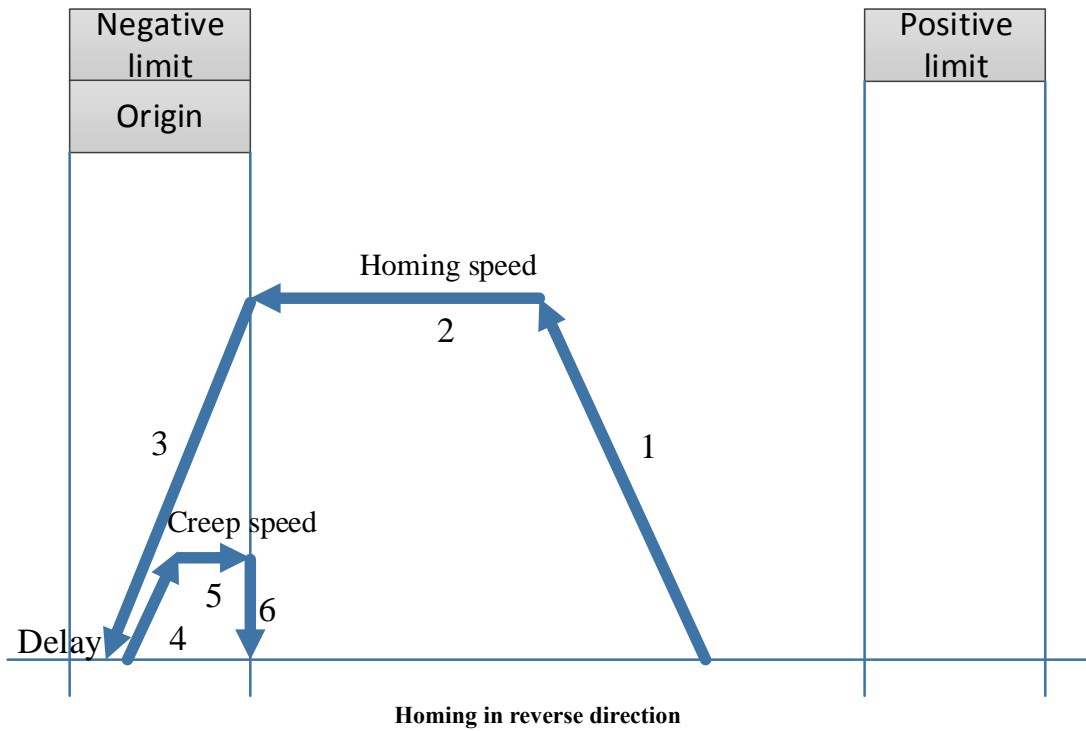

(2) Homing direction: positive

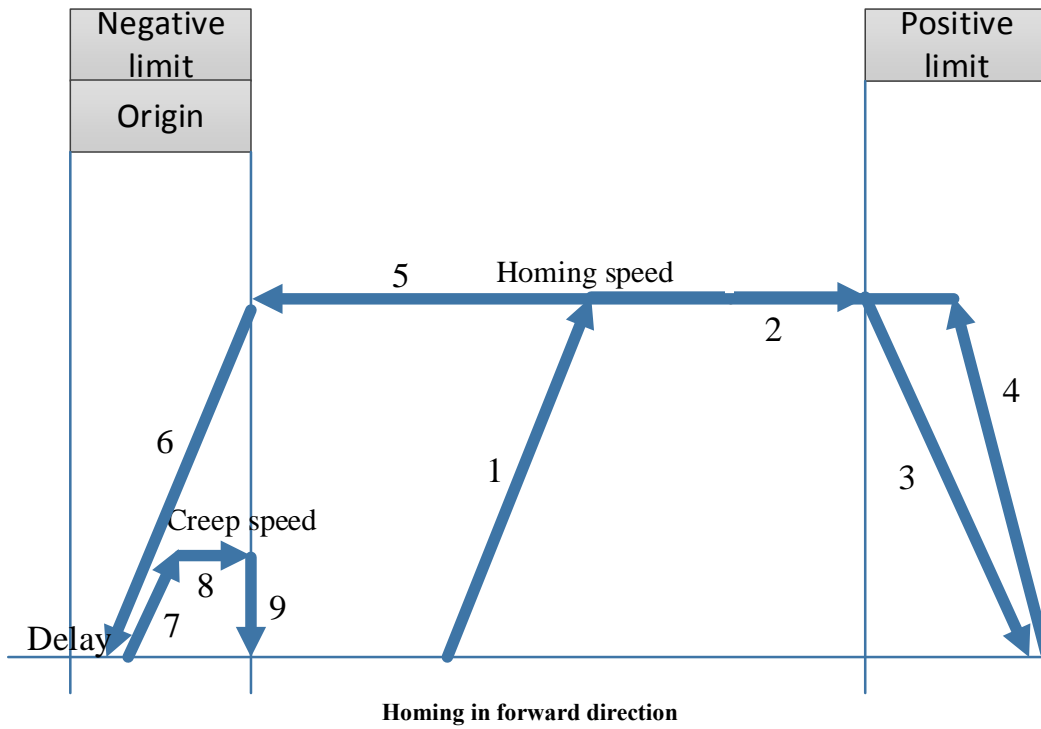

➤ **Start position is at the negative limit**

(1) Homing direction: negative

Command error: homing direction is error, cannot homing.

(2) Homing direction: positive

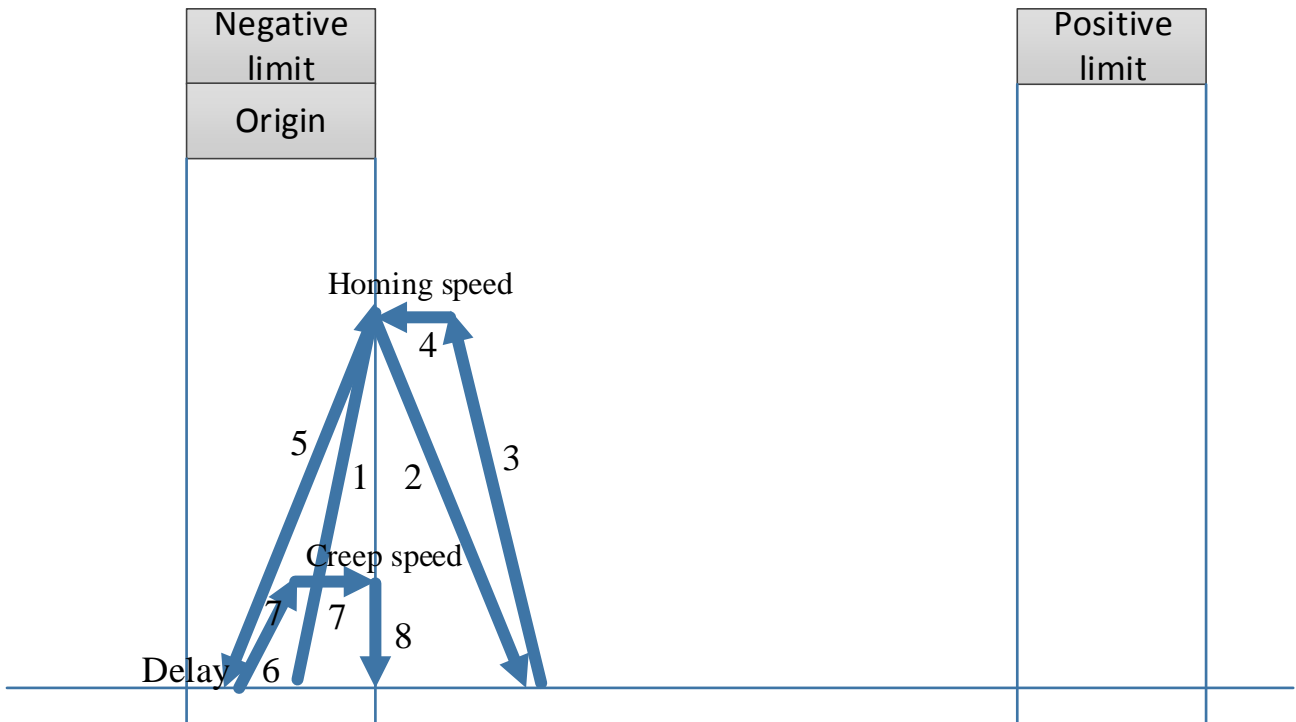

➤ **Start position is at the positive limit**

(1) Homing direction: negative

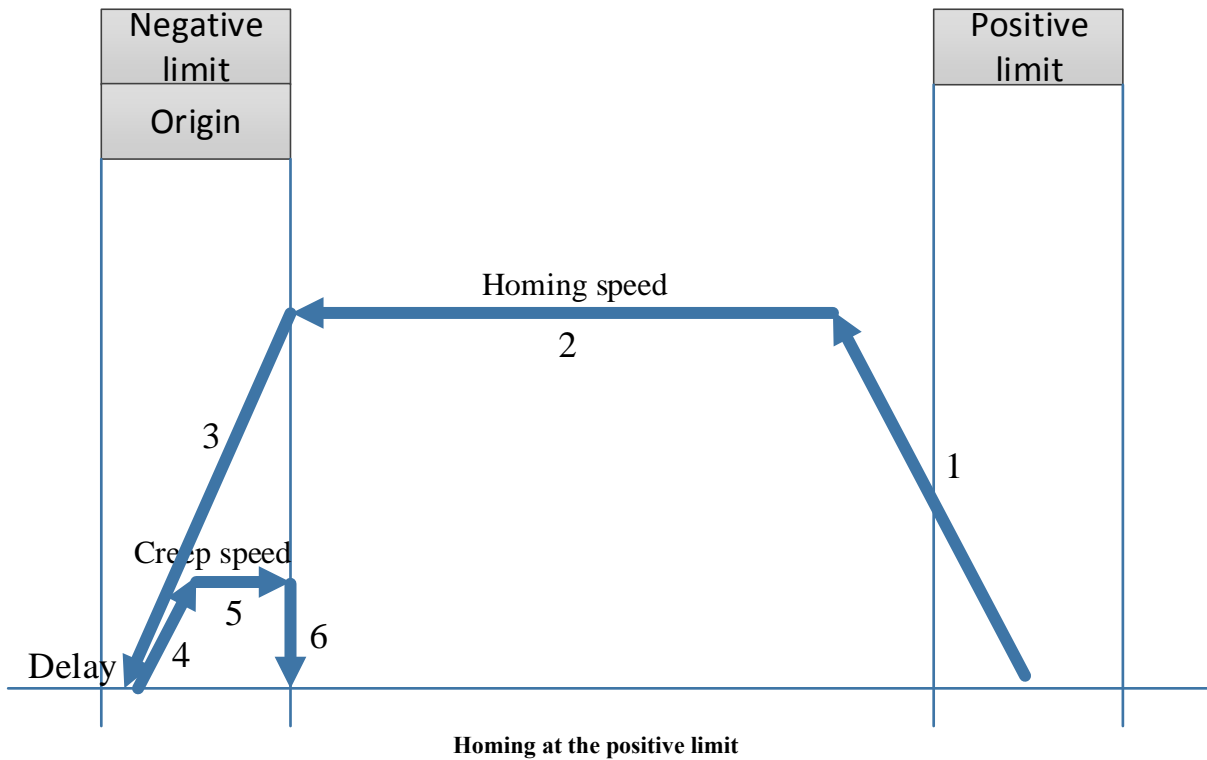

(2) Homing direction: positive

Command error: homing direction is error, cannot homing.

➤ **Start position over the positive limit**

When the starting position of the worktable exceeds the positive limit, in order to prevent the collision accident caused by the positive homing, do not perform the homing operation under this condition. The worktable must be manually moved back between the positive and negative limits before the homing operation.

➤ **Start position over the negative limit**

When the starting position of the worktable exceeds the negative limit, in order to prevent the collision accident caused by the positive homing, do not perform the homing operation under this condition. The worktable must be manually moved back between the positive and negative limits before the homing operation.

5-1-2-15. Gear binding 【A_GEARIN】

(1) Overview

Bind the main axis (or encoder axis) to the slave axis for synchronous movement.

Gear binding 【A_GEARIN】			
Execution condition	Rising/falling edge of the coil	Suitable model	XDH, XLH
Firmware	V3.6.1b and above	Software	3.7.4 and above

(2) Operand

Operand	Function	Type
S0	Input parameter start address	16-bit, single word
S1	Output state word start address	16-bit, single word
S2	Output state bit start address	Bit
S3	Axis output terminal number	16-bit, single word

(3) Suitable soft component

Operand	Word soft component								Bit soft component										
	System								Constant	Module		System							
	D*	FD	TD*	CD*	DX	DY	DM*	DS*	K/H	ID	QD	X	Y	M*	S*	T*	C*		
S0	●	●	●	●	●	●	●	●											
S1	●	●	●	●	●	●	●	●											
S2														●					
S3	●								●										

*: D means D, HD; TD means TD and HTD; CD means CD, HCD, HSCD and HSD; DM means DM and DHM; DS means DS and DHS; M means M, HM, SM; S means S, HS; T means T, HT; C means C, HC.

(4) Function and action



- S0 specifies the input parameter start address, occupies the register S0~S0+23
- S1 specifies output state word start address
- S2 specifies output state bit start address, occupies the relay S2~S2+4
- S3 specifies the axis terminal number
- When M0 is from OFF→ON, bind the main axis S0 to the position of the slave axis S3 for synchronous movement
- S0+1=0, the slave axis is synchronized with the given value ($D20016 + 200 * N$) of the main axis (N is the axis number, starts from 0)
- S0+1=1, the slave axis is synchronized with the feedback ($D20044+200*N$) of the main axis (N is the axis number, starts from 0)
- The axis can be bound during the axis movement, and the acceleration and deceleration of the binding process are determined by S0 + 12 and S0 + 16
- When S0 + 3 [buffer mode] is set to 0, if the slave axis executes the command during the movement, the slave axis immediately stops the current movement and synchronizes with the main axis. When S0 + 3 [buffer mode] is set to 1, if the slave axis executes the command during the movement, it will wait until the current movement of the slave axis ends to synchronize with the main axis
- During axis binding, the electrical origin can be modified at any time by the main axis, but cannot by the slave axis
- After the command is executed, the single axis state ($D20000+200*N$) of the main axis remains unchanged, the single axis state ($D20000+200*N$) of the slave axis switches to 4

(5) Related parameters

Input parameter	Parameter name	Data type	Unit	Note
S0	Master	INT16U	-	main axis number
S0+1	SourceType	INT16U	-	Data source type 0: given 1: feedback
S0+2	ContinuousMode	INT16U	-	Continuously updated. Not supported at the moment
S0+3	BufferMode	INT16U	-	Buffer mode 0: interrupt mode 1: buffer mode
S0+4	Numerator	FP64	-	Synchronous ratio numerator
S0+8	Denominator	FP64	-	Synchronous ratiodenominator
S0+12	Acceleration	FP64	Command unit/s ²	Target acceleration
S0+16	Deceleration	FP64	Command unit /s ²	Target deceleration
S0+20	Jerk	FP64	Command unit /s ³	Target jerk speed, that is, the change speed of acceleration and deceleration
Output parameter	Parameter name	Data type	Unit	Note
S1	ErrCode	INT16U	-	Command error code
State parameter	Parameter name	Data type	Unit	Note
S2	Done	BOOL	-	Synchronizing
S2+1	Busy	BOOL	-	The instruction is being executed
S2+2	Active	BOOL	-	Command under control
S2+3	Abort	BOOL	-	Instruction is interrupted
S2+4	Error	BOOL	-	Instruction execution error
Axis number	Parameter name	Data type	Unit	Note
S3	Slave	INT16U	-	slave axis number

Note:

The relationship between acceleration/deceleration and jerk speed is same to A_MOVEA, please refer to chapter 5-1-2-7 item (5).

(6) Sequence diagram

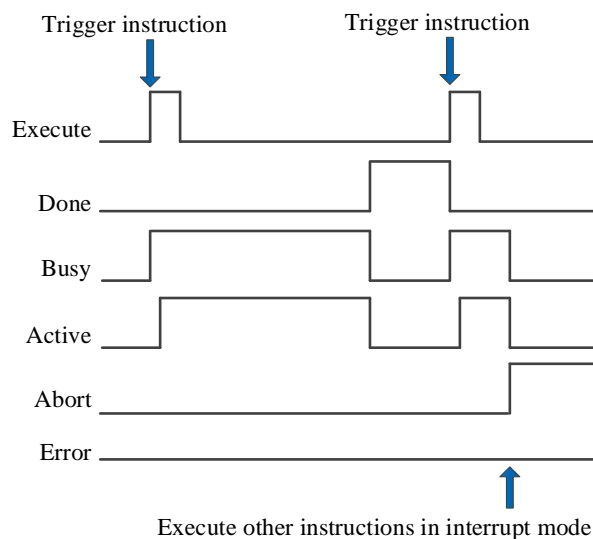

Explanation:

Generally, after the command is triggered, the Busy and Active signals are set, and reset after the command is executed. At the same time, the Done signal is set. Done will reset only after the command is triggered again, otherwise it will not reset automatically.

When the instruction is triggered in the buffer mode and there are currently instructions being executed, the Active signal will be set immediately. The execution of the current instruction ends. When the instruction is executed, the Busy signal will be set. After the execution of the instruction ends, the Busy and Active signals will be reset and the Done signal will be set.

When a new instruction is triggered in interrupt mode during instruction execution, the Busy and Active signals are reset immediately and the Abort signal is set.

When there is an error in the command, the Error signal is set, other signals are reset, and the corresponding error code is output.

(7) Application

Takes axis 0 as the main axis and axis 1 as the slave axis for given synchronous binding through A_GEARIN, so that the main axis can run 10000 command units at the speed of 5000 command unit/s. The acceleration and deceleration is 25000 command unit/s², and the jerk speed is 50000 command unit/s³. The speed of the slave axis is 0.5 times of the main axis.

The ladder chart:

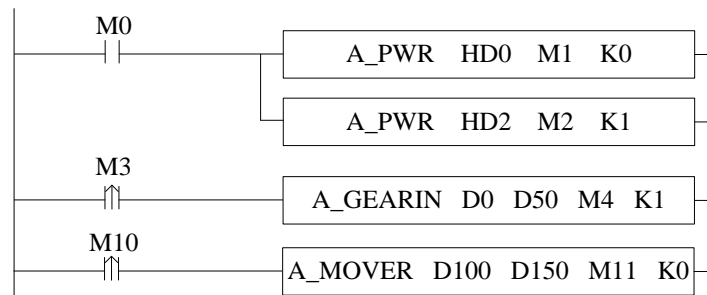

A_GEARINInstruction parameter configuration

Input parameter: Output parameter: Status parameter:

Effective axis num:

Name	Addr	Online value	Offline value	Data type	statement
Input parameter					
MasterIndex	D0	0	0	INT16U	Main shaft no.
SourceType	D1	0	0	INT16U	Synchronous data source
ContinuousMode	D2	Donotupdate	Donotupdate	INT16U	Continuous update mode
BufferMode	D3	interrupt	interrupt	INT16U	The caching pattern
Num	D4	0	0.5	FP64	molecular
Den	D8	0	1	FP64	The denominator
Acc	D12	0	0	FP64	The acceleration
Dec	D16	0	0	FP64	Reduce speed
Jerk	D20	0	0	FP64	With the acceleration
Output parameter					
ErrCode	D50	0		INT16U	Error code
Status parameter					
InGear	M4	False		BIT	sync
Busy	M5	False		BIT	busy
Active	M6	False		BIT	active
Abort	M7	False		BIT	Interrupt status
Err	M8	False		BIT	Error status

space usage : I0-D23,D50-D50,M4-M8.

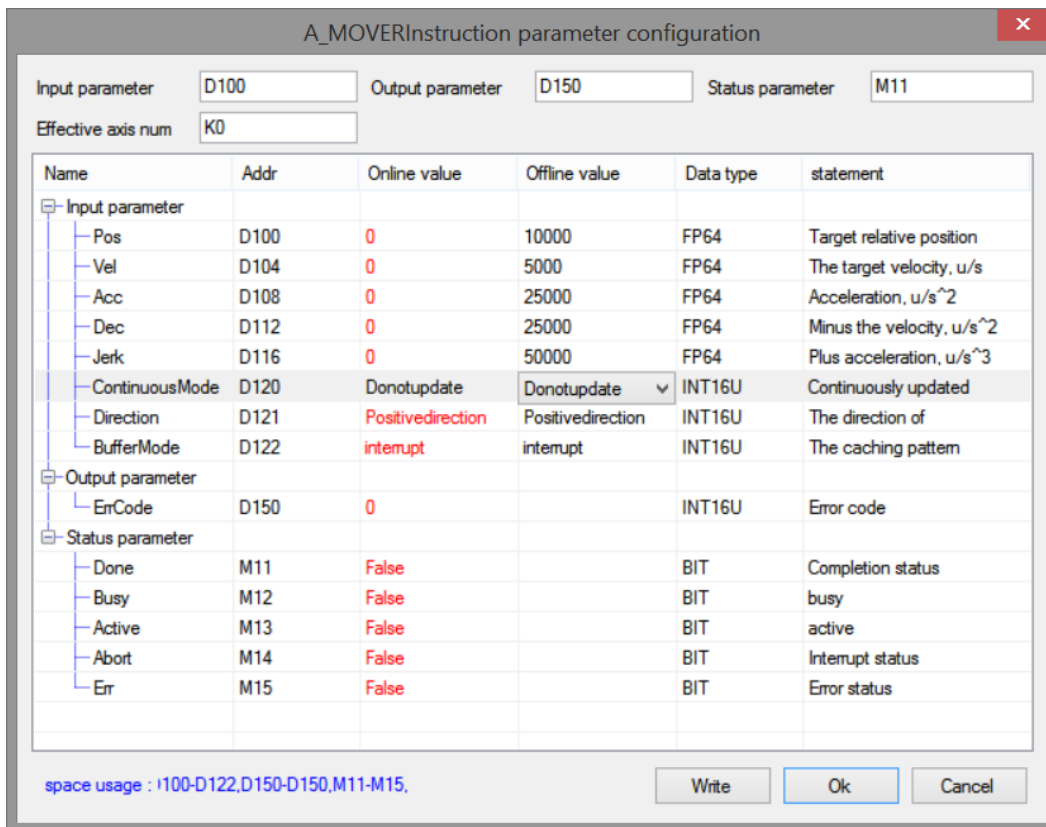

Note: first enable the axis 0 and axis 1 through A_PWR. When M3 is set from off to on, execute the synchronous binding with the parameters set by the command. M1 is set to on when the binding is successful. M10 is set from off to on, axis 0 acts as the main axis to move in relative position, and the slave axis moves in synchronous with the proportion of 0.5.

The execution position curve is as follows:

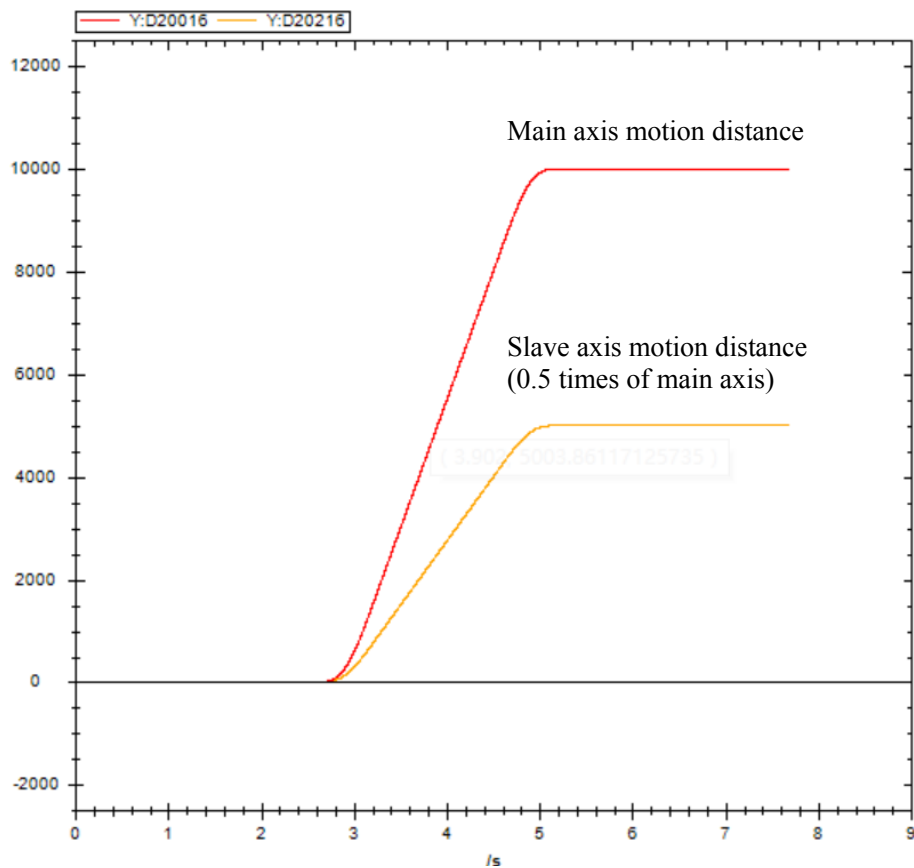

The speed curve is shown as below:

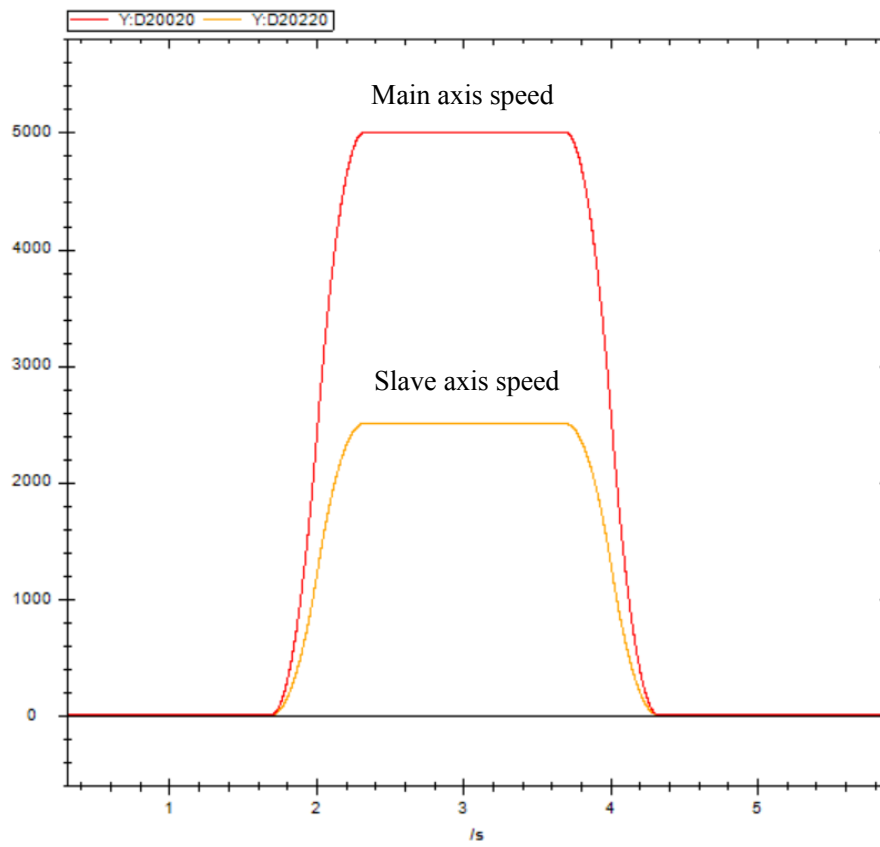

5-1-2-16. Gear unbinding 【A_GEAROUT】

(1) Overview

Desynchronize the main axis (or encoder axis) with the slave axis.

Gear unbinding [A_GEAROUT]			
Execution condition	Rising/falling edge of the coil	Suitable model	XDH, XLH
Firmware	V3.6.1b and above	Software	3.7.4 and above

(2) Operand

Operand	Function	Type
S0	Input parameter start address	64-bit, four words
S1	Output state word start address	16-bit, single word
S2	Output state bit start address	Bit
S3	Axis output terminal number	16-bit, single word

(3) Suitable soft component

Operand	Word soft component								Bit soft component								
	System								Constant	Module		System					
	D*	FD	TD*	CD*	DX	DY	DM*	DS*	K/H	ID	QD	X	Y	M*	S*	T*	C*
S0	●	●	●	●	●	●	●	●									
S1	●	●	●	●	●	●	●	●									
S2														●			
S3	●								●								

*: D means D, HD; TD means TD and HTD; CD means CD, HCD, HSCD and HSD; DM means DM and DHM; DS means DS and DHS; M means M, HM, SM; S means S, HS; T means T, HT; C means C, HC.

(4) Function and action



- S0 specifies the input parameter start address, occupies the register S0~S0+7
- S1 specifies output state word start address
- S2 specifies output state bit start address, occupies the relay S2~S2+3
- S3 specifies the axis terminal number
- When M0 is from OFF→ON, unbind the main axis S0 with the slave axis S3
- The axis can be unbound during the axis movement, the slave axis will deceleration stop with the larger speed between A_GEARIN command and A_GEAROUT command
- After the command is executed, the single axis state (D20000+200*N) of the main axis remains unchanged, the single axis state (D20000+200*N) of the slave axis switches to 1

(5) Related parameters

Input parameter	Parameter name	Data type	Unit	Note
S0	Deceleration	FP64	Command unit/s ²	Target deceleration
S0+4	Jerk	FP64	Command unit /s ³	Target jerk speed, that is, the change speed of acceleration/deceleration
Output parameter	Parameter name	Data type	Unit	Note
S1	ErrCode	INT16U	-	Command error code
State parameter	Parameter name	Data type	Unit	Note

S2	Done	BOOL	-	Instruction execution completed
S2+1	Busy	BOOL	-	The instruction is being executed
S2+2	Abort	BOOL	-	Instruction is interrupted
S2+3	Error	BOOL	-	Instruction execution error
Axis number	Parameter name	Data type	Unit	Note
S3	Axis	INT16U	-	Axis number starts from 0

Note:

The relationship between deceleration and jerk speed is same to A_MOVEA, please refer to chapter 5-1-2-7 item (5).

(6) Sequence diagram

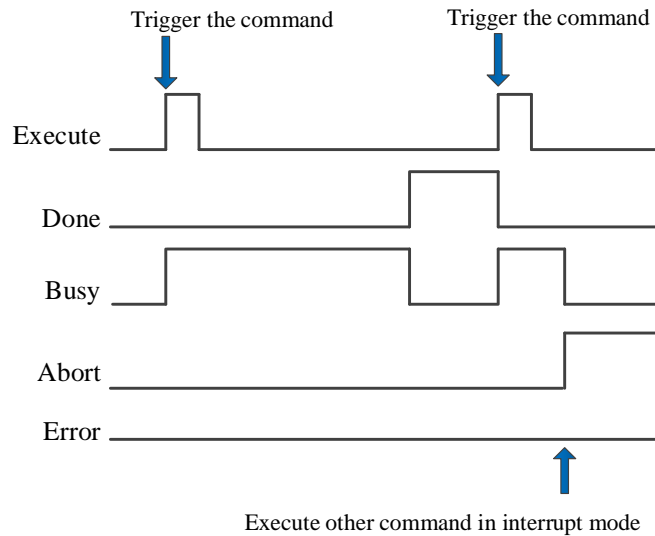

Explanation:

Generally, after the command is triggered, the Busy signal is set, and reset after the command is executed. At the same time, the Done signal is set. Done will reset only after the command is triggered again, otherwise it will not reset automatically.

When the command is interrupted or fault, Abort or Error signal will be set on, other signals will be reset. In case of error, the corresponding error code will be output.

(7) Application

Takes K0 as the main axis and K1 as the slave axis, synchronization coefficient is 1/1, the main axis runs at the speed of 5000 pulse/s. The A_GEAROUT is executed to unbind the slave axis in the motion. The deceleration of A_GEAROUT is 3000 pulse/s², and the jerk speed is 10000 pulse/s³.

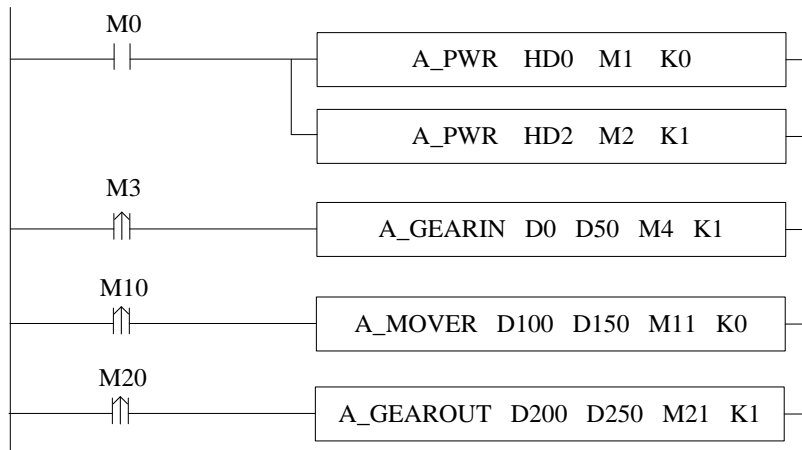

The command configuration is shown as below:

A_GEARINInstruction parameter configuration

Input parameter: Output parameter: Status parameter:

Effective axis num:

Name	Addr	Online value	Offline value	Data type	statement
[-] Input parameter					
MasterIndex	D0	0	0	INT16U	Main shaft no.
Source Type	D1	0	0	INT16U	Synchronous data source
ContinuousMode	D2	Donotupdate	Donotupdate	INT16U	Continuous update mode
BufferMode	D3	interrupt	interrupt	INT16U	The caching pattern
Num	D4	0	1	FP64	molecular
Den	D8	0	1	FP64	The denominator
Acc	D12	0	0	FP64	The acceleration
Dec	D16	0	0	FP64	Reduce speed
Jerk	D20	0	0	FP64	With the acceleration
[-] Output parameter					
ErCode	D50	0		INT16U	Error code
[-] Status parameter					
InGear	M4	False		BIT	sync
Busy	M5	False		BIT	busy
Active	M6	False		BIT	active
Abort	M7	False		BIT	Interrupt status
Err	M8	False		BIT	Error status

space usage : I0-D23,D50-D50,M4-M8.

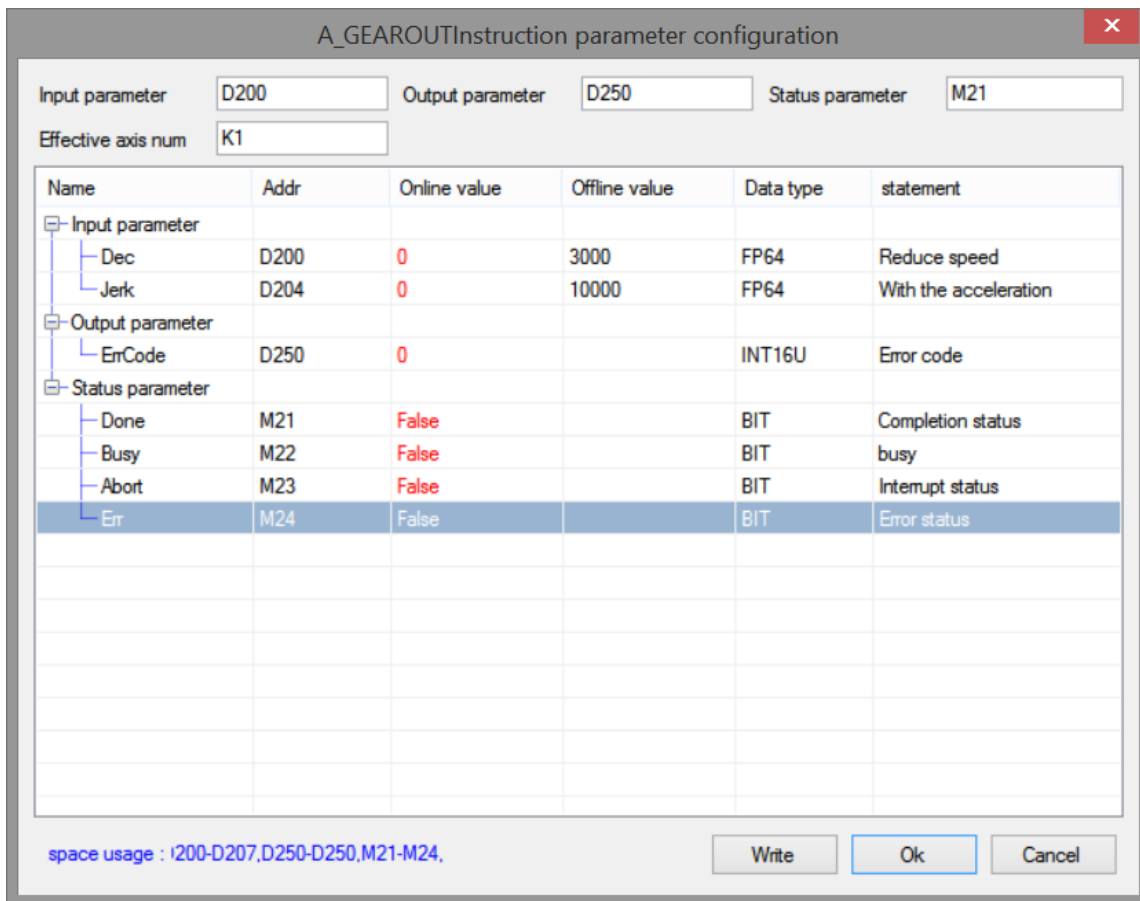

Note: first turns on the enable of axis 0 and axis 1 through A_PWR command. When M3 is from off → on, execute the A_GEARIN instruction to perform synchronous binding. After binding is successful, the instruction completion flag M4 is set to on. The main axis will move through A_MOVER. At this time, the slave axis moves synchronously with the main axis with a binding coefficient of 1/1. During operation, set on M30, A_GEAROUT instruction is executed to unbind.

The position curve is shown as below:

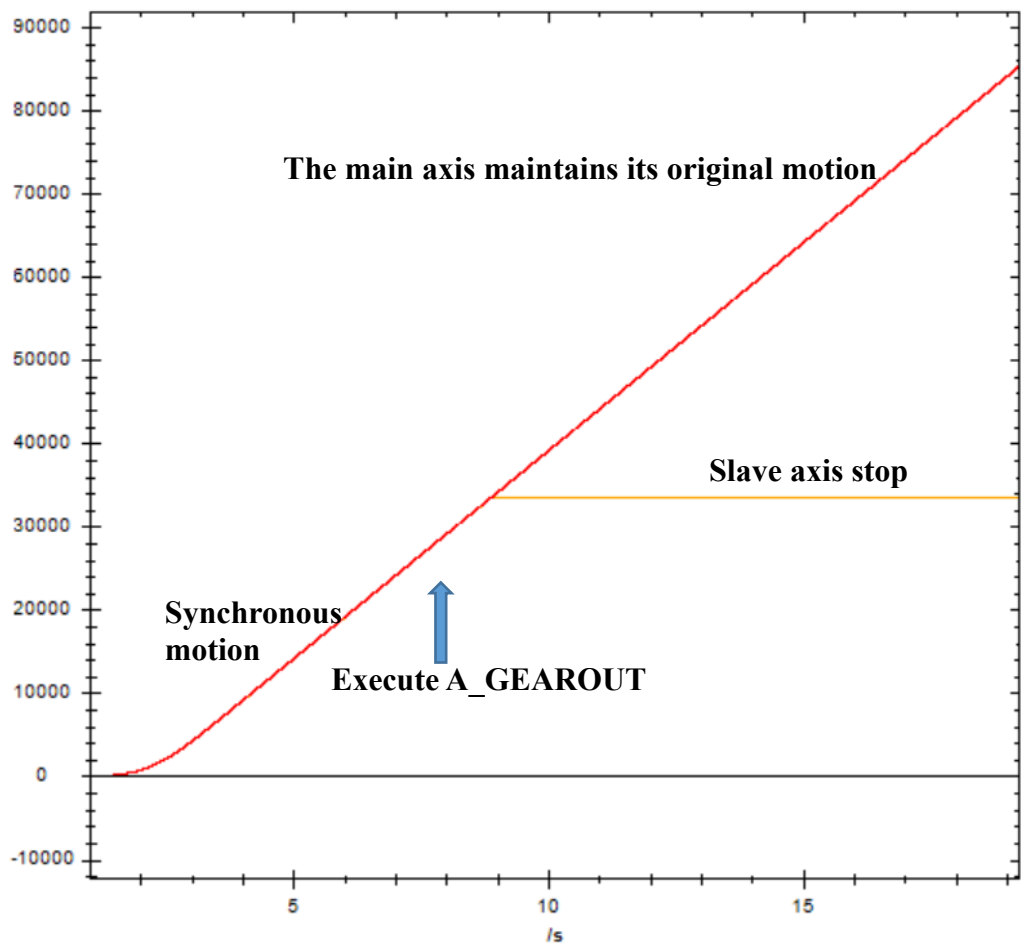

Red is the main axis position curve and yellow is the slave axis position curve. After executing A_GEAROUT, the main axis maintains the original motion. The slave axis stops with the larger deceleration speed between A_GEARIN and A_GEAROUT.

5-1-2-17. Simple absolute position motion 【A_DRVA】

(1) Overview

The command moves in absolute position.

Simple absolute position motion [A_DRVA]			
Execution condition	Rising/falling edge of the coil	Suitable model	XDH, XLH
Firmware	V3.6.1b and above	Software	3.7.4 and above

(2) Operand

Operand	Function	Type
S0	Target position	64-bit, four words
S1	Target speed	64-bit, four words
S2	Acceleration deceleration time	64-bit, four words
S3	Output state bit start address	Bit
S4	Axis output terminal number	16-bit, single word

(3) Suitable soft component

Operand	Word soft component									Bit soft component								
	System								Constant K/H	Module		System						
	D*	FD	TD*	CD*	DX	DY	DM*	DS*		ID	QD	X	Y	M*	S*	T*	C*	
S0	●	●	●	●	●	●	●	●										
S1	●	●	●	●	●	●	●	●										
S2	●	●	●	●	●	●	●	●										
S3														●				
S4	●								●									

*: D means D, HD; TD means TD and HTD; CD means CD, HCD, HSCD and HSD; DM means DM and DHM; DS means DS and DHS; M means M, HM, SM; S means S, HS; T means T, HT; C means C, HC.

(4) Function and action



- S0 specifies the target position
- S1 specifies the target speed
- S2 specifies the target acceleration/deceleration time
- S3 specifies output state bit start address, occupies the relay S3~S3+1
- S4 specifies the output terminal number
- When M0 changes from off to on, perform absolute position movement for the axis specified by S3. Its position parameter is S0, speed parameter is S1, acceleration and deceleration parameter is S2 (Note: the unit of acceleration and deceleration is seconds, that is, the time from initial speed to target speed)
- The usage of A_DRVA is the same as that of A_MOVEA instruction, the difference is A_DRVA instruction can be interrupted by other motion instructions in interrupt mode, but other motion instructions cannot be cached in cache mode, and other motion instructions cannot be interrupted
- After executing the instruction, the single axis state (D20000+200*N) of slave axis is 2
- The direction is determined by the target absolute position and the current position. It is positive when the target position is greater than the current position and negative when the target position is less than the current position

(5) Notes

- A_STOP/A_HALT can be used to stop the motion.
- The instruction has no error code parameters. When any error occurs, state bit Error will be ON. Common errors include that the control mode is not CSP, and the acceleration and deceleration time is 0.

(6) Related parameters

Input parameter	Parameter name	Data type	Unit	Note
S0	Position	FP64	Command unit	Target position
S1	Velocity	FP64	Command unit /s	Target speed
S2	Time	FP64	s	Target acceleration/deceleration time, that is, the time from current speed to target speed
State parameter	Parameter name	Data type	Unit	Note
S3	Done	BOOL	-	Instruction execution completed
S3+1	Error	BOOL	-	Instruction execution error
Axis number	Parameter name	Data type	Unit	Note
S4	Axis	INT16U	-	Axis number starts from 0

(7) Application

The motor current position is 2000, it requires to move to 10000 pulses position with the speed 5000 pulse/s. the acceleration/deceleration time is 0.5s.

Motor position diagram in absolute position mode:

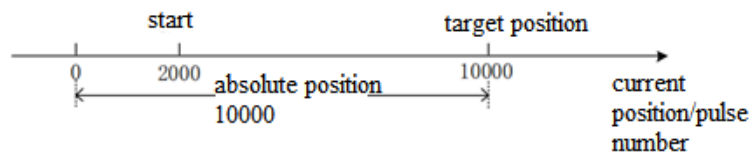

The target position in the command is the absolute position from zero point to target point, so moving to the position of 10000 pulses requires setting the target position 10000.

The ladder chart:

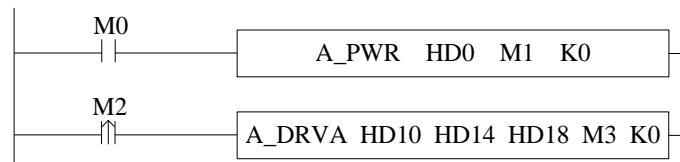

The instruction configuration:

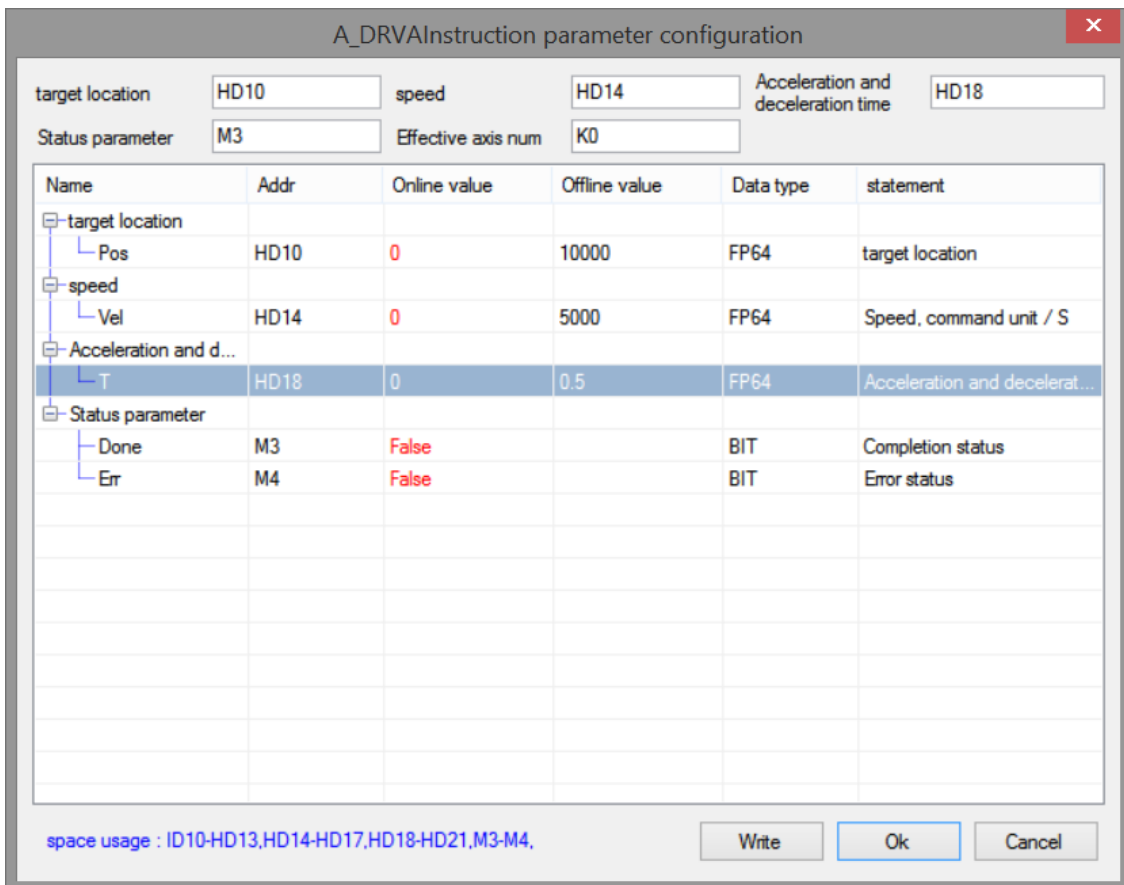

Explanation:

First enable through A_PWR instruction, when M2 is from OFF→ON, move to the target position with setting parameters.

The execution position curve is shown as below:

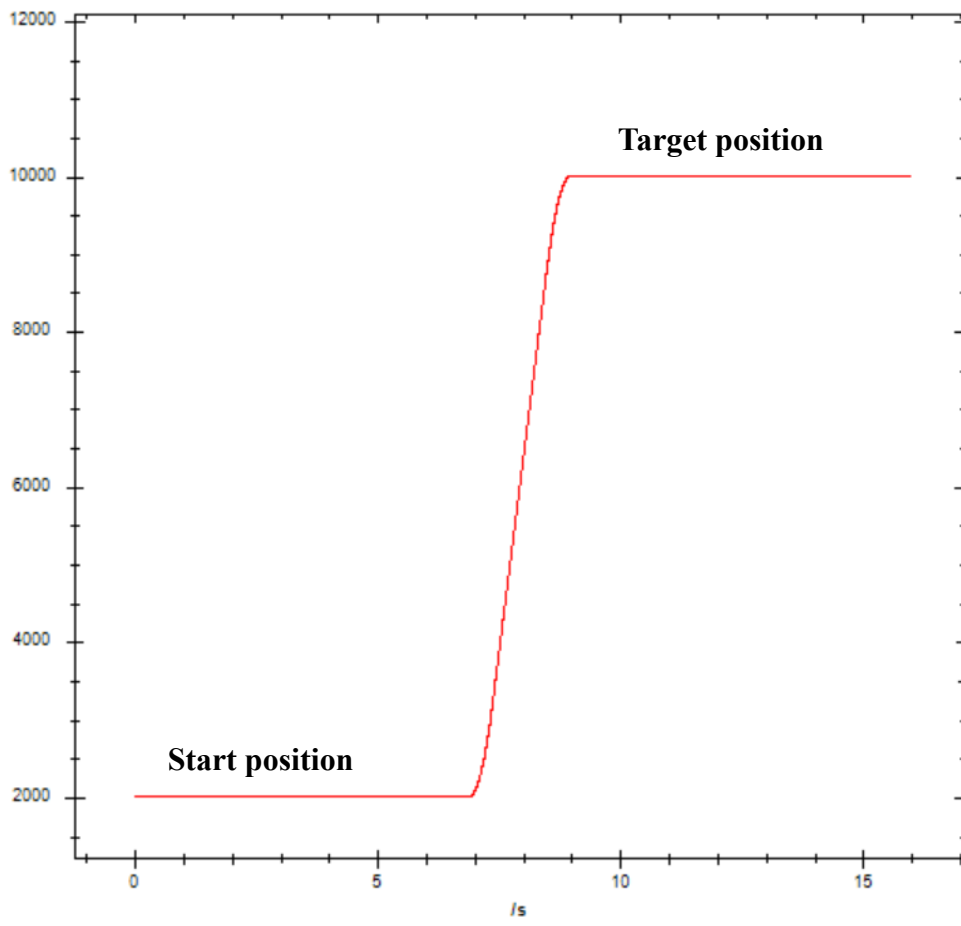

5-1-2-18. Simple relative position motion 【A_DRVI】

(1) Overview

The command moves in relative position.

Simple relative position motion [A_DRVI]			
Execution condition	Rising/falling edge of the coil	Suitable model	XDH, XLH
Firmware	V3.6.1b and above	Software	3.7.4 and above

(2) Operand

Operand	Function	Type
S0	Target position	64-bit, four words
S1	Target speed	64-bit, four words
S2	Acceleration deceleration time	64-bit, four words
S3	Output state bit start address	Bit
S4	Axis output terminal number	16-bit, single word

(3) Suitable soft component

Operand	Word soft component									Bit soft component							
	System								Constant K/H	Module		System					
	D*	FD	TD*	CD*	DX	DY	DM*	DS*		ID	QD	X	Y	M*	S*	T*	C*
S0	●	●	●	●	●	●	●	●									
S1	●	●	●	●	●	●	●	●									
S2	●	●	●	●	●	●	●	●									
S3														●			
S4	●								●								

*: D means D, HD; TD means TD and HTD; CD means CD, HCD, HSCD and HSD; DM means DM and DHM; DS means DS and DHS; M means M, HM, SM; S means S, HS; T means T, HT; C means C, HC.

(4) Function and action



- S0 specifies the target position
- S1 specifies the target speed
- S2 specifies the target acceleration/deceleration time
- S3 specifies output state bit start address, occupies the relay S3~S3+1
- S4 specifies the output terminal number
- When M0 changes from off to on, perform relative position movement for the axis specified by S3. Its position parameter is S0, speed parameter is S1, acceleration and deceleration parameter is S2 (Note: the unit of acceleration and deceleration is seconds, that is, the time from initial speed to target speed)
- The usage of A_DRVI is the same as that of A_MOVER instruction, the difference is A_DRVI instruction can be interrupted by other motion instructions in interrupt mode, but other motion instructions cannot be cached in cache mode, and other motion instructions cannot be interrupted
- After executing the instruction, the single axis state (D20000+200*N) of slave axis is 2
- The direction is determined by the positive/negative of the target position.

(5) Notes

- A_STOP/A_HALT can be used to stop the motion.
- The instruction has no error code parameters. When any error occurs, state bit Error will be ON. Common errors include that the control mode is not CSP, and the acceleration and deceleration time is 0.

(6) Related parameters

Input parameter	Parameter name	Data type	Unit	Note
S0	Position	FP64	Command unit	Target position
S1	Velocity	FP64	Command unit /s	Target speed
S2	Time	FP64	s	Target acceleration/deceleration time, that is, the time from current speed to target speed
State parameter	Parameter name	Data type	Unit	Note
S3	Done	BOOL	-	Instruction execution completed
S3+1	Error	BOOL	-	Instruction execution error
Axis number	Parameter name	Data type	Unit	Note
S4	Axis	INT16U	-	Axis number starts from 0

(7) Application

The motor present position is 2000, it requires to move to 10000 pulses position at the speed of 5000 pulse/s through A_DRVI instruction. The acceleration/deceleration time is 0.5s.

The motor position diagram in relative position mode:

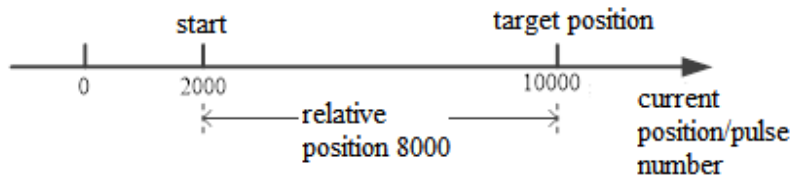

The present position is 2000, it needs to send 8000 pulses to move to 10000 pulses position in relative mode.

The ladder chart is shown as below:

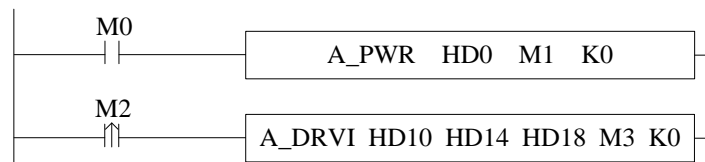

The instruction configuration is shown as below:

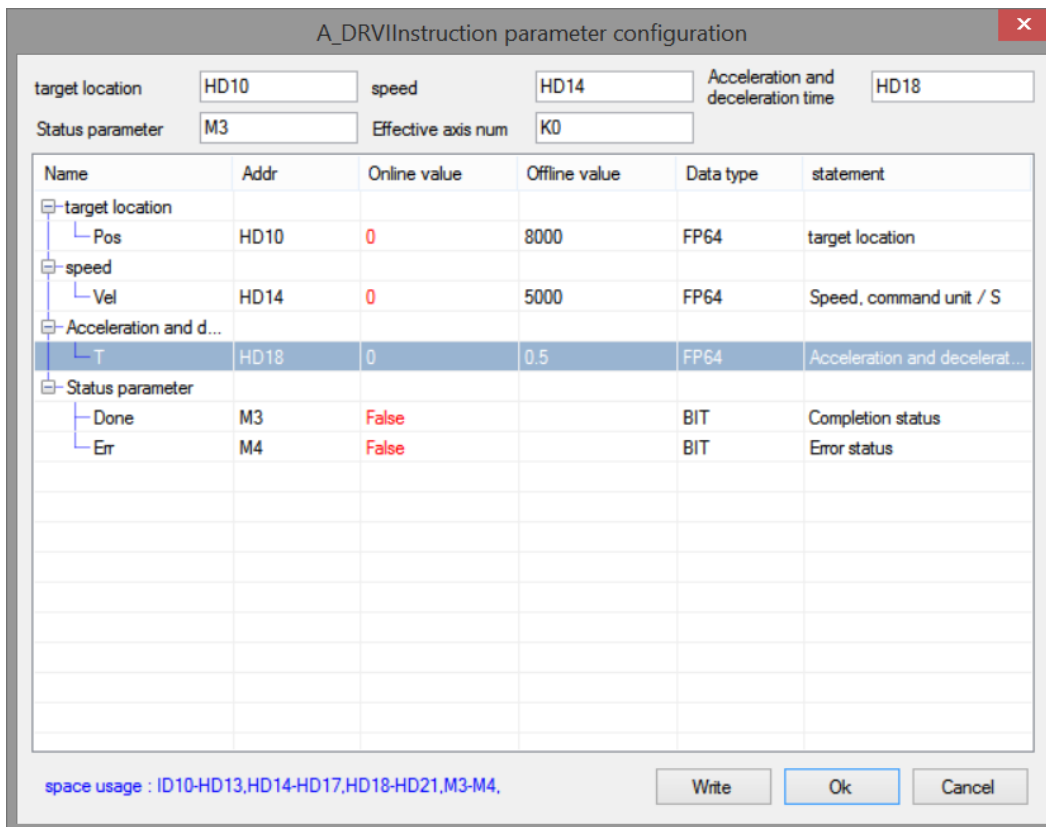

Explanation:

First turn on the enable through A_PWR instruction. When M2 is from OFF→ON, it moves to the target position with setting parameters.

The execution position curve is shown as the following:

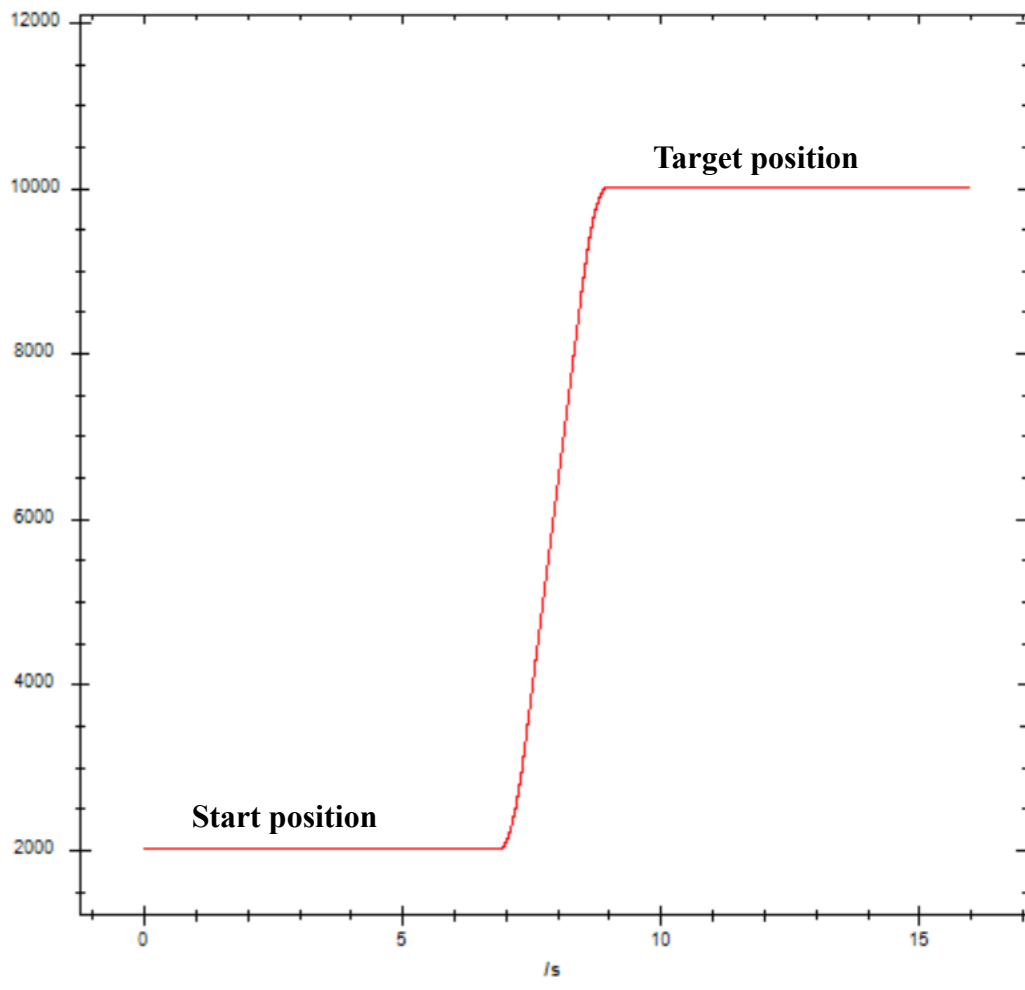

5-1-2-19. Probe function 【A_PROBE】

(1) Overview

The probe function is the position latch function, which latches the current position when the command is triggered.

Probe function [A_PROBE]			
Execution condition	Normally ON/OFF coil	Suitable	XDH, XLH
Firmware	V3.6.1b and above	Software	3.7.4 and above

(2) Operand

Operand	Function	Type
S0	Input parameter start address	16-bit, single word
S1	Output state word start address	16-bit, single word
S2	Output state bit start address	Bit
S3	Axis output terminal number	16-bit, single word

(3) Suitable soft component

Operand	Word soft component										Bit soft component						
	System								Constant K/H	Module ID QD		System					
	D*	FD	TD*	CD*	DX	DY	DM*	DS*				X	Y	M*	S*	T*	C*
S0	●	●	●	●	●	●	●	●									
S1	●	●	●	●	●	●	●	●									
S2														●			
S3									●								

*: D means D, HD; TD means TD and HTD; CD means CD, HCD, HSCD and HSD; DM means DM and DHM; DS means DS and DHS; M means M, HM, SM; S means S, HS; T means T, HT; C means C, HC.

(4) Function and action

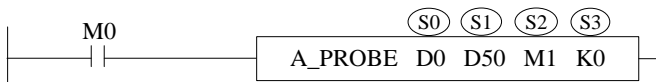

- S0 specifies input parameter start address, occupies the register S0~S0+24
- S1 specifies output state word start address, occupies the register S1~S1+11
- S2 specifies output state bit start address, occupies the relay S2~S2+3
- S3 specifies the axis terminal number, only can select EtherCAT axis
- When M0 is from OFF→ON, turn on the probe for the axis specified by S3. Write the current position value to the latch register
- It needs to distribute the specified axis Ethercat parameter 60B8h, 60B9h, 60Bah, 60BBh, 60BCh, 60BDh to the PDO mapping (60BAh~60BDh are distributed as the probe using condition, the PDO size cannot over 32 bytes). At present, only the signal from the slave station is supported as the probe trigger source. See EtherCAT motion control manual for the configuration mode of PDO.
- It takes a certain time from the generation of external trigger signal to the driver receiving signal and position locking. Therefore, the value of probe locking must have an error with the theoretical value. The error is related to the motor speed, hardware performance and software processing
- After executing the instruction, the slave station single axis state (D20000+200*N) keeps unchanged
- Only one probe command can be written for the same axis, otherwise double coils will be generated

(5) Notes

- Only one probe command can be written for the same axis, otherwise double coils will be generated
- When probe 1 and probe 2 are enabled at the same time, the position will not be refreshed until both probes are triggered
- When the trigger source is the master station, the trigger signal needs to select the corresponding external interrupt port, and there needs to be a corresponding external interrupt program in the program (see the example at the end of this section for specific use)
- The command is not supported by the pulse axis

(6) Related parameters

Input parameter	Parameter name	Data type	Unit	Note
S0	Index	INT16U	-	Probe number 0: probe 1 1: probe 2 2: probe 1 and probe 2
S0+1	Source1	INT16U	-	Probe 1 trigger source 0: slave station 1: main station
S0+2	Edge1	INT16U	-	Probe 1 trigger edge 0: rising edge 1: falling edge
S0+3	Signal1	INT16U	-	Probe 1 trigger signal 0: external signal 1: Z phase signal 2: external interrupt 0, X2 3: external interrupt 1, X3 4: external interrupt 2, X4 5: external interrupt 3, X5 6: external interrupt 4, X6 7: external interrupt 5, X7 8: external interrupt 6, X10 9: external interrupt 7, X11 10: external interrupt 8, X12 11: external interrupt 9, X13
S0+4	WindowStart1	FP64	Command unit	Probe 1 window start position
S0+8	WindowEnd1	FP64	Command unit	Probe 1 window end position
S0+12	WindowUsed1	INT16U	-	Window index 0: not use window 1: use window
S0+13	Source2	INT16U	-	Probe 2 trigger source 0: slave station 1: main station
S0+14	Edge2	INT16U	-	Probe 2 trigger edge 0: rising edge 1: falling edge
S0+15	Signal2	INT16U	-	Probe 2 trigger signal 0: external signal 1: Z phase signal 2: external interrupt 0, X2 3: external interrupt 1, X3 4: external interrupt 2, X4 5: external interrupt 3, X5 6: external interrupt 4, X6 7: external interrupt 5, X7 8: external interrupt 6, X10 9: external interrupt 7, X11 10: external interrupt 8, X12 11: external interrupt 9, X13
S0+16	WindowStart2	FP64	Command unit	Probe 2 window start position
S0+20	WindowEnd2	FP64	Command unit	Probe 2 window end position
S0+24	WindowUsed2	INT16U	-	Window index 0: not use window

Input parameter	Parameter name	Data type	Unit	Note
				1: use window
Output parameter	Parameter name	Data type	Unit	Note
S1	ErrCode	INT16U	-	Command error code
S1+4	Position1	FP64	Command unit	Probe 1 latch position
S1+8	Position2	FP64	Command unit	Probe 2 latch position
State parameter	Parameter name	Data type	Unit	Note
S2	Done	BOOL	-	Instruction execution completed
S2+1	Busy	BOOL	-	The instruction is being executed
S2+2	Abort	BOOL	-	Instruction is interrupted
S2+3	Error	BOOL	-	Instruction execution error
Axis number	Parameter name	Data type	Unit	Note
S3	Axis	INT16U	-	The axis number starts from 0

Note:

The window of the probe represents the range of the latch position. When the window is enabled, only the current position when the probe is triggered is written to the latch position within the window range.

(7) Sequence diagram

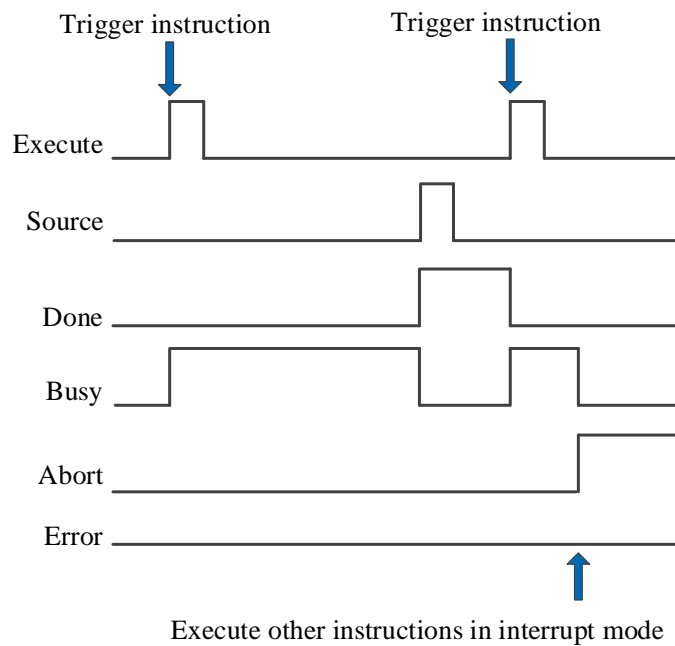

Explanation:

Generally, after the command is triggered, the Busy signal is set. Only after the edge signal of the trigger source is detected to refresh the position, the Done signal is set and the Busy signal is reset. Only after the command is triggered and executed again, the Done will be reset, otherwise it will not be reset automatically.

When there is an error in the instruction or the instruction is interrupted, the Error or Abort signal is set, other signals are reset, and the corresponding error code will be output in case of error.

(8) Application

Eg1: The specified axis is required to turn on the probe function, the probe trigger source is the slave station, and the probe trigger records the current position. The ladder diagram is as follows

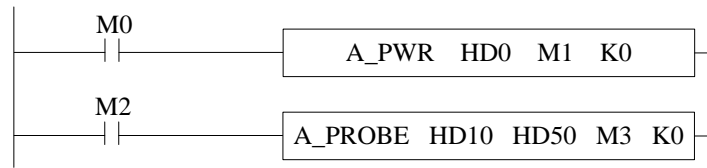

The command configuration is shown as below:

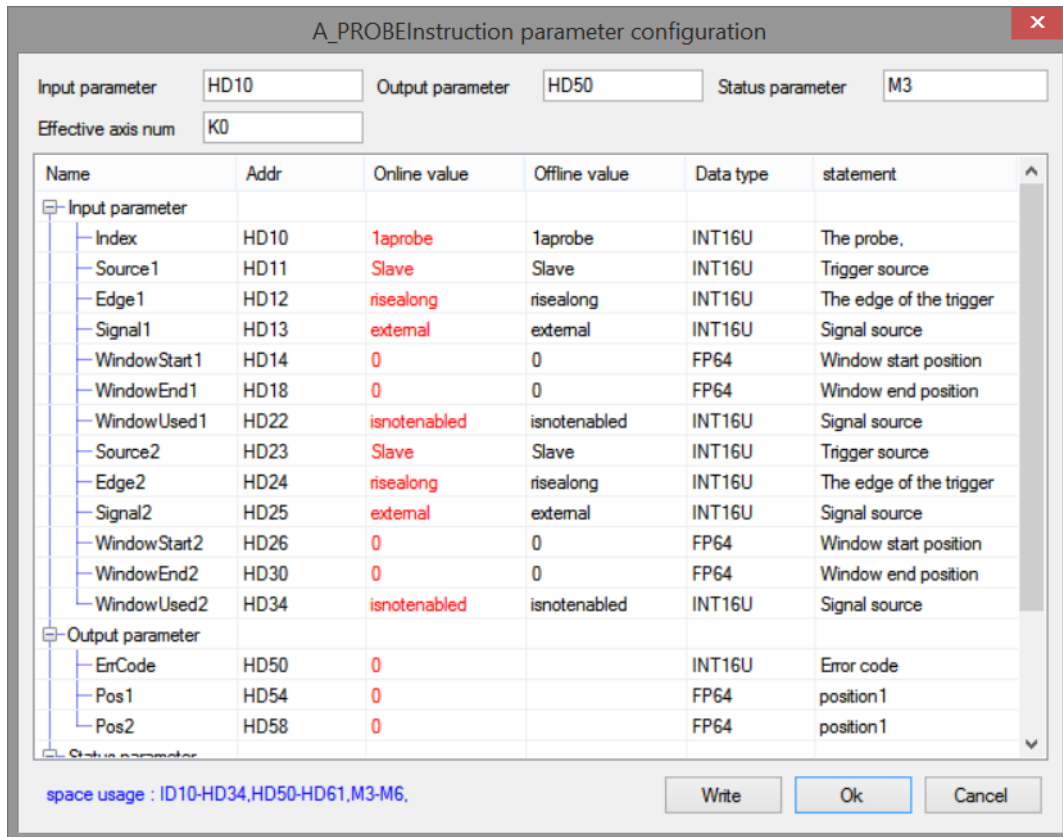

Explanation:

When selecting the slave station for the probe trigger source, the expert process data is required to configure the parameters related to the probe function 60B8h, 60B9h, 60Bah, 60BCh. After setting, trigger A_PROBE command can start the probe, and the probe signal terminal is set by the slave station.

Take DS5C as an example, P5-62 and P5-63 are used for terminal allocation of probe function. The default value of P5-62 is 5, that is, the terminal of probe 1 is P-, and the default value of P5-63 is 6, that is, the terminal of probe 2 is D-, probe 1 can only be allocated to P-, and probe 2 can only be allocated to D-.

When the probe is turned on, whenever the level signal of the probe terminal jumps, the probe will be triggered. At this time, the current position value will be stored in the probe latch position (register address specified by S1 + 4 and S1 + 8 in the instruction)

Expert process data configuration is shown as below:

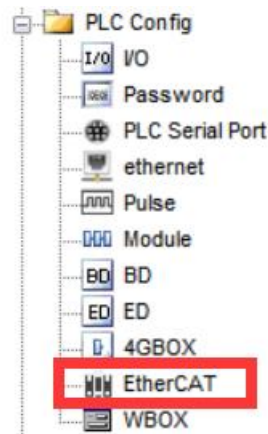

常规 专家过程数据 启动参数 IO映射 COE-Online ESC寄存器

同步管理器

SM	大小	类型
0		邮箱输出
1		邮箱输入
2	15.0	输出
3	23.0	输入

PDO分配

#x1600

#x1601

#x1602

#x1603

PDO列表

索引	大小	名称	标志	SM
#x1600	15.0	1st RxPDO Mapping		2
#x1601	6.0	2nd RxPDO Mapping		
#x1602	6.0	3rd RxPDO Mapping		
#x1603	4.0	4th RxPDO Mapping		
#x1a00	23.0	1st TxPDO Mapping		3
#x1a01	12.0	2nd TxPDO Mapping		
#x1a02	12.0	3rd TxPDO Mapping		
#x1a03	12.0	4th TxPDO Mapping		

PDO内容: 添加 编辑 删除 上移 下移

索引:子索引	大小	偏移	名称	类型
#x6040:00	2.0	0.0	Control Word	UINT
#x607A:00	4.0	2.0	TargetPosition	DINT
#x60FF:00	4.0	6.0	TargetVelocity	DINT
#x6071:00	2.0	10.0	TargetTorque	INT
#x6060:00	1.0	12.0	ModeOfOperation	SINT
#x60B8:00	2.0	13.0	Touch Probe Func...	UINT

配置读取 配置写入 激活 确定 取消

常规 专家过程数据 启动参数 IO映射 COE-Online ESC寄存器

同步管理器

SM	大小	类型
0		邮箱输出
1		邮箱输入
2	15.0	输出
3	23.0	输入

PDO分配

#x1a00

#x1a01

#x1a02

#x1a03

PDO列表

索引	大小	名称	标志	SM
#x1600	15.0	1st RxPDO Mapping		2
#x1601	6.0	2nd RxPDO Mapping		
#x1602	6.0	3rd RxPDO Mapping		
#x1603	4.0	4th RxPDO Mapping		
#x1a00	23.0	1st TxPDO Mapping		3
#x1a01	12.0	2nd TxPDO Mapping		
#x1a02	12.0	3rd TxPDO Mapping		
#x1a03	12.0	4th TxPDO Mapping		

PDO内容: 添加 编辑 删除 上移 下移

索引:子索引	大小	偏移	名称	类型
#x6041:00	2.0	0.0	Status Word	UINT
#x6064:00	4.0	2.0	ActualPosition	DINT
#x606C:00	4.0	6.0	Velocity actual ...	DINT
#x6077:00	2.0	10.0	ActualTorque	INT
#x6061:00	1.0	12.0	ModeOfOperationD...	SINT
#x60B9:00	2.0	13.0	Touch Probe Status	UINT
#x60BA:00	4.0	15.0	Touch Probe Pos1...	DINT
#x60BC:00	4.0	19.0	Touch Probe Pos2...	DINT

配置读取 配置写入 激活 确定 取消

Please add the PDO parameters according to the related index. As the above photo, 60B8h is added in RxPDO #x1600. 60B9h, 60Bah, 60BCh are added in TxPDO #x1a00. (this example uses the rising edge of the probe signal, if the falling edge is used, please add 60B9h, 60BBh, 60BDh in #x1a00)

Eg2: The specified axis is required to turn on the probe function, use the rising edge of X2 port of the master station as the trigger source, and the probe is triggered to record the current position. The ladder diagram is as follows:

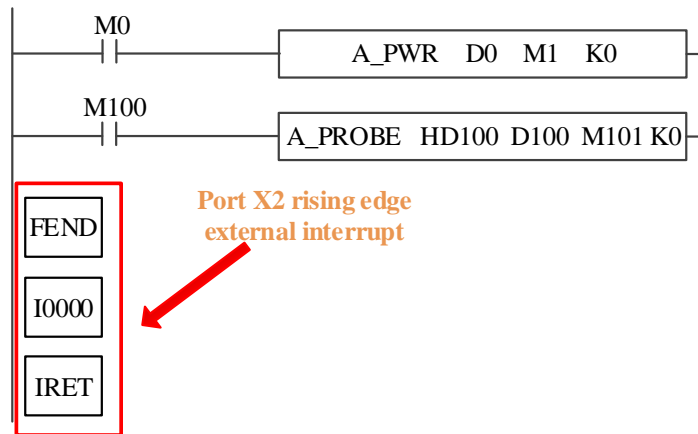

The command configuration is shown as below:

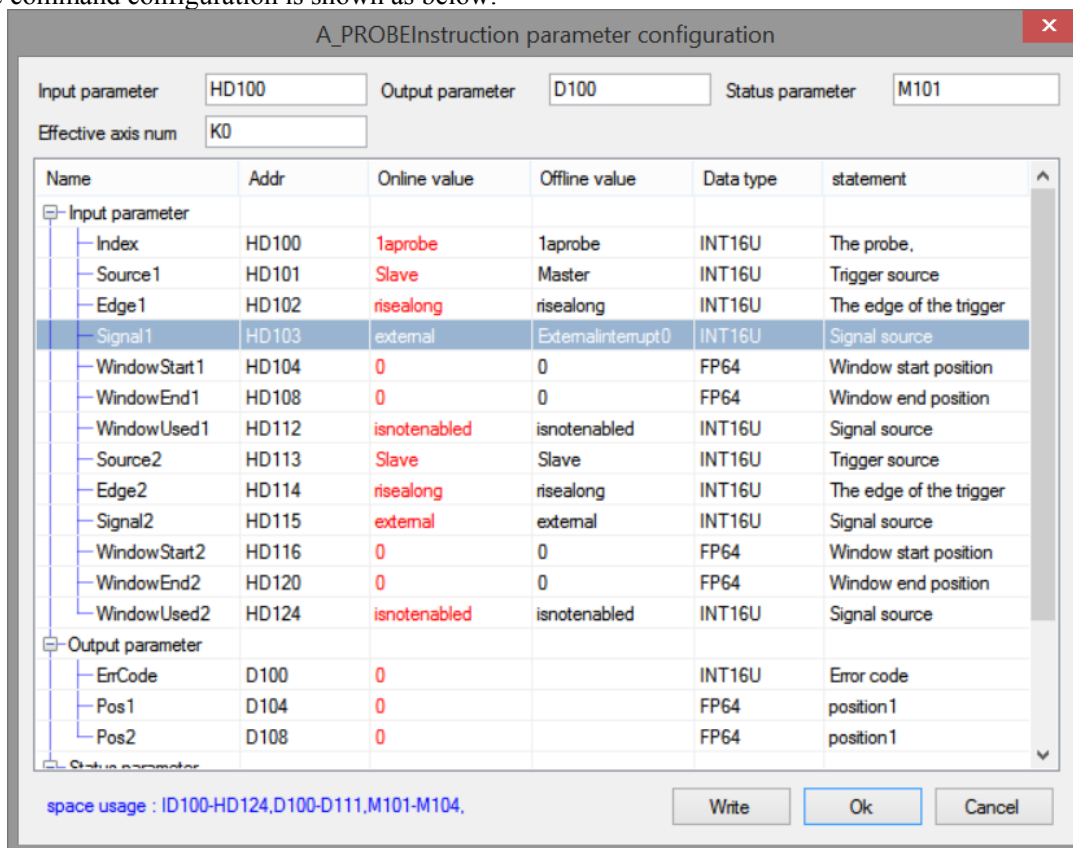

Explanation:

Since the master station is used as the trigger source, there should be an external interrupt program of the corresponding port in the program, and the corresponding external interrupt needs to be selected during instruction configuration. The relevant PDO configuration is the same as that in example 1.

After triggering the instruction and generating a rising edge at port X2, the instruction will latch the position of the specified axis into the corresponding register.

5-1-2-20. Periodic position control motion 【A_CYCPOS】

(1) Overview

Performs periodic position control on the specified axis.

Periodic position control motion [A_CYCPOS]			
Execution condition	Rising/falling edge of the coil	Suitable model	XDH, XLH
Firmware	V3.6.1b and above	Software	3.7.4 and above

(2) Operand

Operand	Function	Type
S0	Input parameter start address	64-bit, four words
S1	Output state word start address	16-bit, single word
S2	Output state bit start address	Bit
S3	Axis output terminal number	16-bit, single word

(3) Suitable soft component

Operand	Word soft component										Bit soft component						
	System								Constant	Module		System					
	D*	FD	TD*	CD*	DX	DY	DM*	DS*	K/H	ID	QD	X	Y	M*	S*	T*	C*
S0	●	●	●	●	●	●	●	●									
S1	●	●	●	●	●	●	●	●									
S2														●			
S3									●								

*: D means D, HD; TD means TD and HTD; CD means CD, HCD, HSCD and HSD; DM means DM and DHM; DS means DS and DHS; M means M, HM, SM; S means S, HS; T means T, HT; C means C, HC.

(4) Function and action



- S0 specifies input parameter start address, occupies the register S0~S0+5
- S1 specifies output state word start address
- S2 specifies output state bit start address, occupies the relay S2~S2+4
- S3 specifies the axis terminal number
- When M0 changes from off to on, perform periodic position control on the axis specified by S3. After successful execution, S2 is set to on, indicating that the axis is in periodic control state. The axis is controlled by periodically assigning values to S0
- Before triggering the command, please ensure that the value of S0 is the same as the current position, otherwise the position will produce a step
- The periodic position control needs to periodically write the target position value into the register, and the position change should not be too large to avoid the flying of the slave axis due to the large difference between the given periodic position and the previous periodic position.
- A_WRITE command can be used to change the target location or in combination with I9900 cycle interrupt. After executing the instruction, set on SM1995 to trigger the interrupt and continuously accumulate the values in the position register, so as to realize that the periodic position control. The direction is jointly determined by the parameter target position and the current position. It is positive when the target position is greater than the current position and negative when the target position is less than the current position.

(5) Related parameters

Input parameters	Parameter name	Data type	Unit	Note
S0	Position	FP64	Command unit	Target position
S0+4	Direction	INT16U	-	Direction. Not supported at the moment.
S0+5	BufferMode	INT16U	-	Buffer mode

Output parameter	Parameter name	Data type	Unit	Note
S1	ErrCode	INT16U	-	Command error code
State parameter	Parameter name	Data type	Unit	Note
S2	Incycle	BOOL	-	Periodic control
S2+1	Busy	BOOL	-	The instruction is being executed
S2+2	Active	BOOL	-	Command under control
S2+3	Abort	BOOL	-	Instruction is interrupted
S2+4	Error	BOOL	-	Instruction execution error
Axis number	Parameter name	Data type	Unit	Note
S3	Axis	INT16U	-	Axis number starts from 0

(6) Sequence diagram

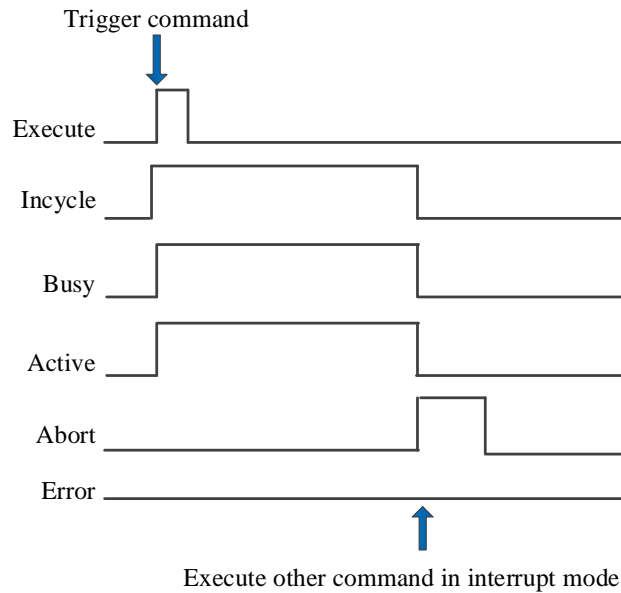

Explanation:

Trigger command, Busy and Active signals are set, and Incycle signal is set when the axis reaches periodic control.

During cycle control, other commands are executed in interrupt mode, Abort signal is set, and Incycle, Busy and Active signals are reset.

5-1-2-21. Periodic speed control motion 【A_CYCVEL】

(1) Overview

Switch the servo mode to CSV mode and output the given target speed to the servo in the task cycle.

Periodic speed control motion [A_CYCVEL]			
Execution condition	Rising/falling edge of the coil	Suitable model	XDH, XLH
Firmware	V3.7.1 and above	Software	3.7.4 and above

(2) Operand

Operand	Function	Type
S0	Input parameter start address	64-bit, four words
S1	Output state word start address	16-bit, single word
S2	Output state bit start address	Bit
S3	Axis output terminal number	16-bit, single word

(3) Suitable soft component

Operand	Word soft component								Bit soft component										
	System								Constant	Module		System							
	D*	FD	TD*	CD*	DX	DY	DM*	DS*	K/H	ID	QD	X	Y	M*	S*	T*	C*		
S0	●	●	●	●	●	●	●	●											
S1	●	●	●	●	●	●	●	●											
S2														●					
S3									●										

*: D means D, HD; TD means TD and HTD; CD means CD, HCD, HSCD and HSD; DM means DM and DHM; DS means DS and DHS; M means M, HM, SM; S means S, HS; T means T, HT; C means C, HC.

(4) Function and action



- S0 specifies input parameter start address
- S1 specifies output state word start address
- S2 specifies output state bit start address
- S3 specifies the axis terminal number
- When M0 changes from off → on, perform periodic speed motion control on the axis specified by S3. After successful execution, S2 is set, indicating that the target axis is in periodic control state, and the axis speed is controlled by periodically assigning values to S0

(5) Notes

- The switching mode is issued by the controller, but the actual switching time is determined by the servo
- Executing the motion command can switch the servo to CSP mode, but it needs to meet the current feedback speed of three cycles ≤ maximum speed * 0.1
- The last mode is still running between the start of mode switching and the success of mode switching
- The command is not supported by the pulse axis

(6) Related parameters

Input parameter	Parameter name	Data type	Unit	Note
S0	Velocity	FP64	Command unit/s	Target speed
S0+4	Buffermode	INT16U	-	Buffer mode 0: interrupt mode 1: buffer mode

Output parameter	Parameter name	Data type	Unit	Note
S1	ErrCode	INT16U	-	Command error code
State parameter	Parameter name	Data type	Unit	Note
S2	Incycle	BOOL	-	Periodic control
S2+1	Busy	BOOL	-	The instruction is being executed
S2+2	Active	BOOL	-	Command under control
S2+3	Abort	BOOL	-	Instruction is interrupted
S2+4	Error	BOOL	-	Instruction execution error
Axis number	Parameter name	Data type	Unit	Note
S3	Axis	INT16U	-	Axis number starts from 0

(7) Sequence diagram

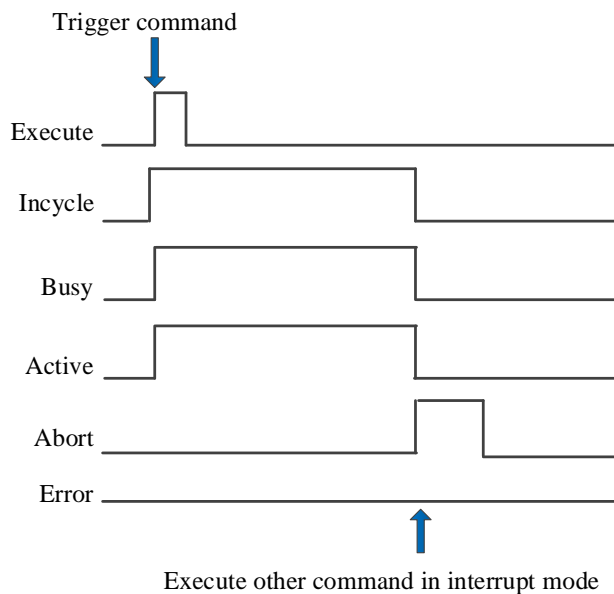

Explanation:

Trigger command, Busy and Active signals are set, and Incycle signal is set when the axis reaches periodic control.

During cycle control, other commands are executed in interrupt mode, Abort signal is set, and Incycle signal is reset.

(8) Application

For example, the servo is required to run at the speed of 131072 pulse/s in CSV mode, and then increase the speed by 131072 pulse/s every 5 seconds. When the speed reaches 3 times the initial speed, it will continue to run at this speed. The ladder diagram is shown in the following figure:

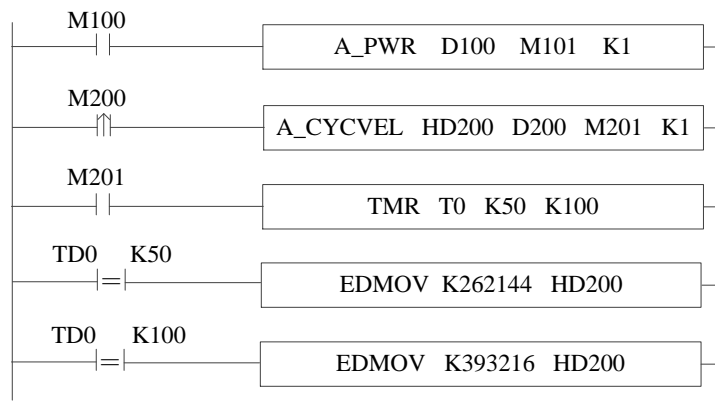

The command configuration is shown as below:

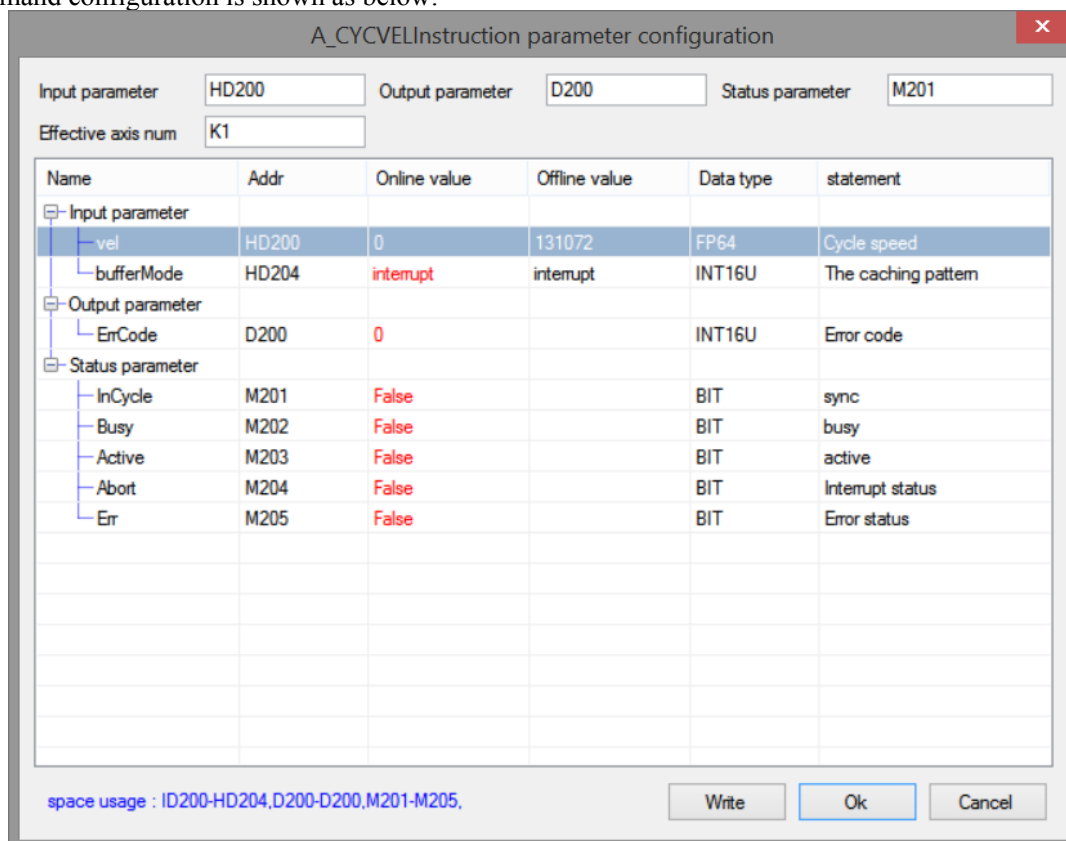

Explanation:

Turn M100 from off → on to enable the axis. When M200 from off → on, trigger the periodic speed control command, the axis switches to CSV mode and runs at a uniform speed of 131072. When the axis reaches the synchronous state, start timing. When 5s timing reached, assign the speed 262144 to the register of the corresponding cycle speed of CYCVEL command. The axis immediately accelerates to the speed value and runs at a uniform speed. When 10s timing reached, the operation and axis action are the same as above.

The speed curve is shown as below:

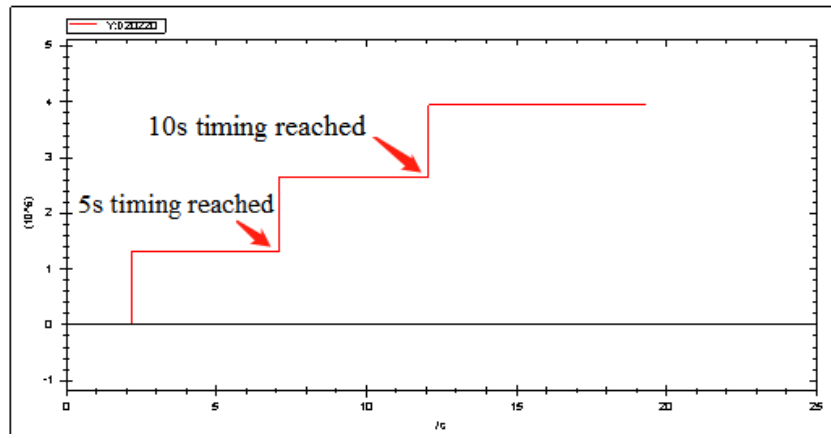

5-1-2-22. Periodic torque control motion 【A_CYCTRQ】

(1) Overview

Switch the servo mode to CST mode and output the given target torque to the servo in the task cycle.

Periodic torque control motion [A_CYCTRQ]			
Execution condition	Rising/falling edge of the coil	Suitable model	XDH, XLH
Firmware	V3.7.1 and above	Software	3.7.4 and above

(2) Operand

Operand	Function	Type
S0	Input parameter start address	64-bit, four words
S1	Output state word start address	16-bit, single word
S2	Output state bit start address	Bit
S3	Axis output terminal number	16-bit, single word

(3) Suitable soft component

Operand	Word soft component								Bit soft component								
	System								Constant	Module		System					
	D*	FD	TD*	CD*	DX	DY	DM*	DS*	K/H	ID	QD	X	Y	M*	S*	T*	C*
S0	●	●	●	●	●	●	●	●									
S1	●	●	●	●	●	●	●	●									
S2														●			
S3									●								

*: D means D, HD; TD means TD and HTD; CD means CD, HCD, HSCD and HSD; DM means DM and DHM; DS means DS and DHS; M means M, HM, SM; S means S, HS; T means T, HT; C means C, HC.

(4) Function and action



- S0 specifies input parameter start address
- S1 specifies output state word start address
- S2 specifies output state bit start address
- S3 specifies the axis terminal number
- When M0 changes from off to on, perform periodic torque motion control on the axis specified by S3. After successful execution, S2 is set on, indicating that the target axis is in periodic control state, and the control of the axis is achieved by periodically assigning values to S0.
- It needs to assign 6080h in EtherCAT parameters of the specified axis to PDO mapping to make [maximum speed limit] effective

(5) Notes

- The switching mode is issued by the controller, but the actual switching time is determined by the servo
- Executing the motion command can switch the servo to CSP mode, which needs to meet the current feedback speed of three cycles \leq maximum speed \times 0.1
- The last mode is still running between the start of mode switching and the success of mode switching
- The command is not supported by the pulse axis

(6) Related parameters

Input parameter	Parameter name	Data type	Unit	Note
S0	Trq	FP64	Command unit/s	Target torque
S0+4	Maxvel	FP64	Rpm	Max speed limit

S0+8	BufferMode	INT16U	-	Buffer mode
Output parameter	Parameter name	Data type	Unit	Note
S1	ErrCode	INT16U	-	Command error code
State parameter	Parameter name	Data type	Unit	Note
S2	Incycle	BOOL	-	Periodic control
S2+1	Busy	BOOL	-	The instruction is being executed
S2+2	Active	BOOL	-	Command under control
S2+3	Abort	BOOL	-	Instruction is interrupted
S2+4	Error	BOOL	-	Instruction execution error
Axis number	Parameter name	Data type	Unit	Note
S3	Axis	INT16U	-	Axis number starts from 0

(7) Sequence diagram

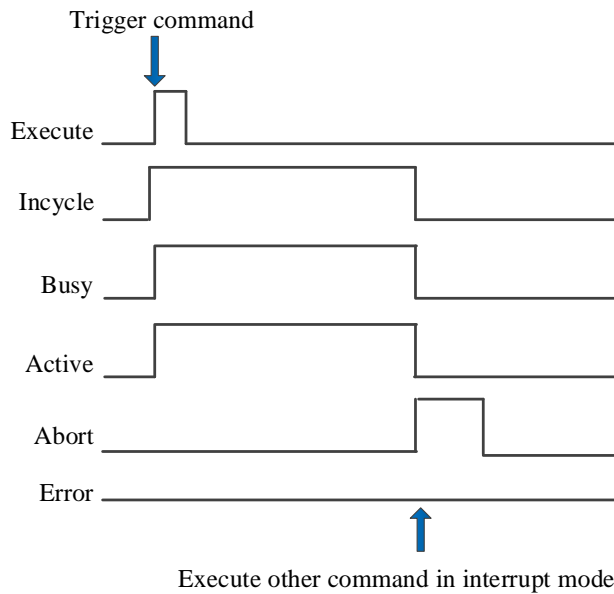

Explanation:

Trigger command, Busy and Active signals are set, and Incycle signal is set when the axis reaches periodic control.

During cycle control, other commands are executed in interrupt mode, Abort signal is set, and Incycle signal is reset.

(8) Application

For example, the servo is required to operate at 15% of the rated torque in CST mode, and then increase the speed by 5% of the rated torque every 5 seconds. When the torque reaches 3 times of the initial speed, it will continue to operate at this torque. The ladder diagram is shown in the following figure:

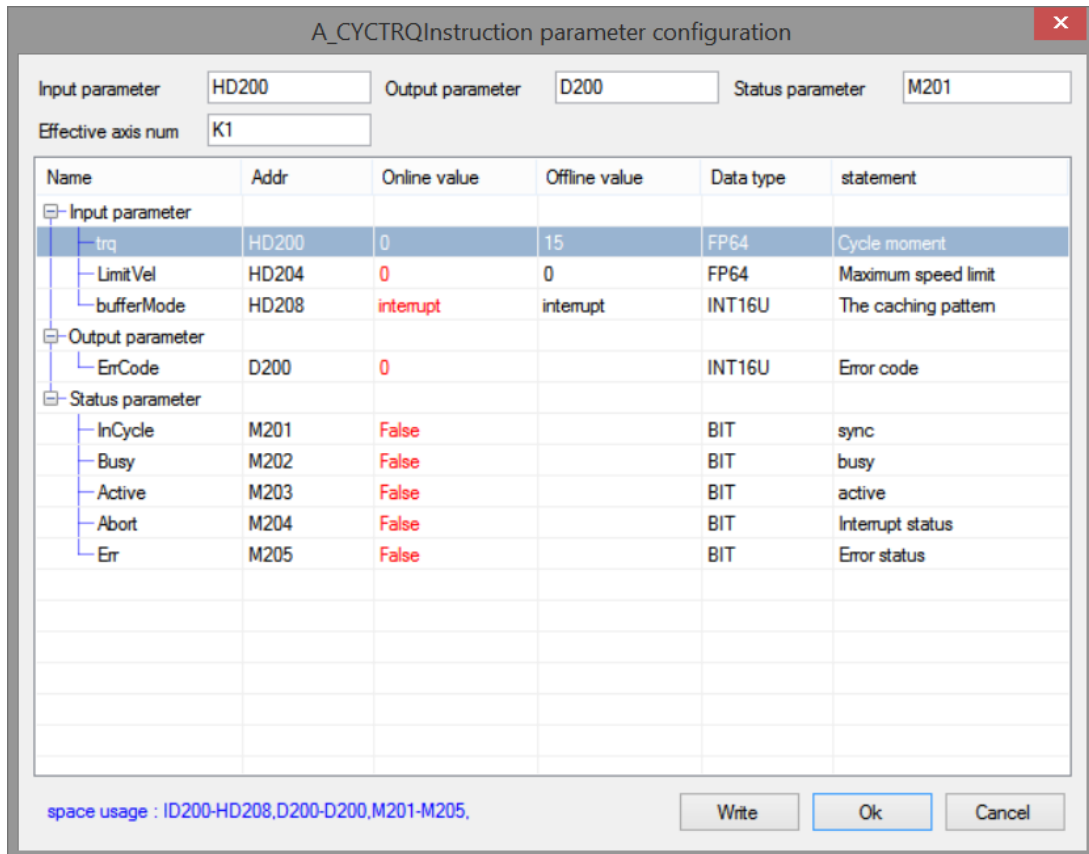
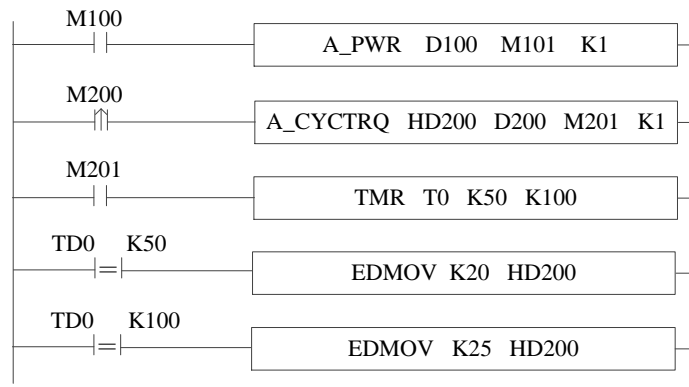

Explanation:

Turn M100 from off → on and enable the axis. When M200 is from off → on, trigger the periodic torque control command, the axis switches to CST mode and runs at a uniform speed of 15% of the rated torque. When the axis reaches the synchronous state, the timing starts. When 5s is timed, assign 20% of the rated torque to the register of the corresponding periodic torque of CYCTRQ command, and the axis immediately accelerates to the torque value and runs at a uniform speed. When 10s is counted, the operation and axis action are the same as above.

The speed curve is shown as below:

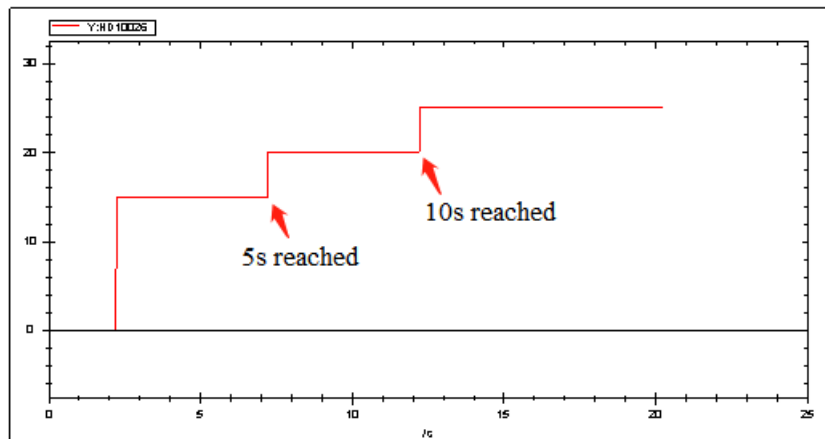

5-1-3. Related coil and register

After the relevant register is modified, it will take effect after power on again.

System parameters

Address	Definition	Data type	Initial value	Note
SFD810	Axis number	INT16U	32	Setting value \geq Actual number of connected axis
SFD811	Motion control mode startup mode	INT16U	0	0: C motion* ¹ 1: H motion 2: userdefine mode* ²
SFD814	Axis bit state start address	INT32U	20000	Axis related coil start address
SFD816	Axis word state start address	INT32U	20000	Axis related register start address

*1: C motion does not support all commands and parameters in this manual. See EtherCAT motion control user manual for specific usage.

*2: In userdefine mode, all servos will be switched to user-defined mode, and the user can change the object word at will.

Axis configuration parameters (N is corresponding axis number, N=0~31)

Basic parameters

Address	Definition	Data type	Unit	Initial value	Note
SFD8000+300*N	Axis type*	INT16U	-	0	0: Real axis 1: Virtual axis 2: Encoder axis
SFD8001+300*N	Command output channel	INT16U	-	0	0: EtherCAT 1: pulse 2: X-NET. Not supported at the moment
SFD8002+300*N	Corresponding slave station no. *	INT16U	-	N	Corresponding axis number in the command
SFD8003+300*N	Display unit	INT16U	-	0	0: pulse 1: mm 2: °
SFD8004+300N	Pulse per rotate	INT32U	Pulse number	131072	The count value feedback by one revolution of the encoder is set according to the actual number of motor encoder lines (for example, if the motor encoder is a 17-bit encoder, i.e. 131072 revolution, this parameter is set to 131072)
SFD8006+300*N	Encoder axis input terminal	INT16U	-	0	When the axis is set as the encoder axis, it is set as the number of the encoder corresponding to the high-speed counting port (if it is connected to high-speed counting HSC0, it is set as 0; if it is connected to high-speed counting HSC2, it is set as 1; if it is connected to high-speed counting HSC4, it is set as 2)
SFD8007+300*N	Gantry slave axis	INT16U	-	0	0: disable

Address	Definition	Data type	Unit	Initial value	Note
	enable				1: enable In synchronous binding, an error from the slave axis will not cancel the binding relationship
SFD8008+300*N	Movement per turn	FP64	Command unit	131072	Equivalent of motion. That is, how many pulses are sent in the command to turn the motor for one turn
SFD8012+300*N	Enable the reducer	INT16U	-	0	0: disable 1: enable
SFD8014+300*N	Workpiece side coefficient of reducer *	INT32U	-	0	SFD8012 set to 1, this parameter will take effect
SFD8016+300*N	Motor side coefficient of reducer *	INT32U	-	0	SFD8012 set to 1, this parameter will take effect
SFD8018+300*N	Motion direction	INT16U	-	0	0: not reverse 1: reverse direction
SFD8019+300*N	Position command output filter time	INT16U	ms	0	Position given filtering. This will cause the actual axis motion to lag
SFD8020+300*N	Count type	INT16U	-	0	0: line 1: rotation. Not support at the moment.
SFD8024+300*N	Rotation count upper limit	FP64	Command unit	0	Not support at the moment
SFD8028+300*N	Rotation count lower limit	FP64	Command unit	0	Not support at the moment
SFD8032+300*N	Back clearance compensation value	FP64	Command unit	0	Not support at the moment
SFD8036+300*N	Emergency stop mode	INT16U	-	0	Emergency stop mode when triggering emergency stop 0: given stop 1: feedback stop. When the speed is high, the use of feedback stop emergency stop may lead to servo alarm

***Note:**

[ENUM]: enumeration data, occupying single word register.

[axis type]: when the axis type is set to 2 (encoder axis), the encoder input port also needs to be set, and the two parameters need to be used together. At the same time, the encoder axis can only be used as the main axis in the binding command or cam command. The value of high-speed counting will directly affect the position of the encoder axis and drive the slave axis to move.

[slave station number]: the slave station number and the function mapping number in the EtherCAT configuration interface correspond to the axis number in the command, so the slave station number can be modified in the axis configuration interface or in the EtherCAT configuration interface.

[reducer]: workpiece side coefficient: motor side coefficient = set speed: actual speed

For example, if the ratio of workpiece side coefficient to motor side coefficient is 10:1, when the set speed is 10 r/min, the actual motor speed is 1 r/min.

Probe position

Address	Meaning	Data type	Unit	Initial value	Note
SFD8194+300*N	Probe encoder pulse equivalent	FP64	Command unit	0	When using the probe command on the encoder axis, the equivalent value needs to be set

Limit configuration parameters

Address	Definition	Data type	Unit	Initial value	Note
SFD8040+300*N	Hard limit stop mode	INT16U	-	0	1: Emergency stop 3: deceleration stop
SFD8041+300*N	Forward hard limit port	INT16U	-	65535	X terminal corresponding to forward hard limit signal. The parameter is octal, that is, the corresponding octal of X10 terminal is 10 and the corresponding decimal is 8
SFD8042+300*N	Forward hard limit polarity	INT16U	-	0	0: polarity not reversed 1: Polarity reversed
SFD8043+300*N	Reverse hard limit port	INT16U	-	65535	X terminal corresponding to reverse hard limit signal. The parameter is octal, that is, the corresponding octal of X10 terminal is 10 and the corresponding decimal is 8
SFD8044+300*N	Reverse hard limit polarity	INT16U	-	0	0: polarity not reversed 1: Polarity reversed
SFD8048+300*N	Hard limit stop deceleration speed	FP64	Command unit/s	65536000	
SFD8052+300*N	Hard limit stop max deceleration distance	FP64	Command unit	10000000000	Maximum stop distance after hard limit triggering. (if the deceleration is greater, stop by deceleration; if the deceleration distance is shorter, stop by deceleration distance)
SFD8060+300*N	Soft limit	INT16U	-	0	0: disable 1: enable
SFD8061+300*N	Soft limit detection mode and stop mode	INT16U	-	0	0: detection command, deceleration stop 1: detection command, emergency stop When the detection command D20016+ 200*N reaches soft limit, it will deceleration stop or emergency stop
SFD8064+300*N	Forward limit value of soft limit	FP64	Command unit	10000000000	
SFD8068+300*N	Reverse limit value of soft limit	FP64	Command unit	-10000000000	
SFD8072+300*N	Soft limit stop deceleration speed	FP64	Command unit /s	65536000	The actual stop deceleration speed is the larger value of the deceleration between this parameter and the motion command
SFD8076+300*N	Soft limit stop max deceleration distance	FP64	Command unit	10000000000	Maximum stop distance of soft limit. (if the deceleration is greater, stop by deceleration; if the deceleration distance is shorter, stop by

Address	Definition	Data type	Unit	Initial value	Note
					deceleration distance, and finally stop within the soft limit)

Performance parameters

Address	Definition	Data type	Unit	Initial value	Note
SFD8080+300*N	Max speed	FP64	Command unit/s	6553600	If the speed parameter in the command is higher than the maximum speed, it will run at the maximum speed
SFD8084+300*N	Max acceleration speed	FP64	Command unit /s ²	65536000	If the acceleration parameter in the command is higher than the maximum acceleration, it will run at the maximum acceleration
SFD8088+300*N	Max deceleration speed	FP64	Command unit /s ²	65536000	If the deceleration parameter in the command is higher than the maximum deceleration, it will run at the maximum deceleration
SFD8092+300*N	Max jerk speed	FP64	Command unit /s ³	655360000	If the jerk speed parameter in the command is higher than the maximum jerk speed, it will run at the maximum jerk speed
SFD8096+300*N	Default speed percentage	INT16U	-	100	Single axis mode does not take effect
SFD8097+300*N	Default acceleration speed percentage	INT16U	-	100	When the acceleration in the command is set to 0, it is executed as the highest acceleration * default acceleration percentage
SFD8098+300*N	Default deceleration speed percentage	INT16U	-	100	When the deceleration in the command is set to 0, it is executed as the maximum deceleration * default deceleration percentage
SFD8099+300*N	Default jerk speed percentage	INT16U	-	100	When the jerk speed in the command is set to 0, it is executed as the maximum jerk speed * default jerk speed percentage

Detection and alarm parameters

Address	Definition	Data type	Unit	Initial value	Note
SFD8120+300*N	Position offset alarm value	FP64	Command unit	0	When the deviation between the given position of the command and the feedback position exceeds this value, an error will be reported. When the parameter is set to 0, the position deviation alarm is not enabled.
SFD8124+300*N	Positioning complete width	FP64	Command unit	100	When the command target position reaches the set value and the difference from the

Address	Definition	Data type	Unit	Initial value	Note
					actual encoder position does not exceed the positioning completion width, the completion flag is set to on
SFD8128+300*N	Electrical zero detection width	FP64	Command unit	100	If the current position is within the range of electrical origin, M20004+50*N is set to on
SFD8132+300*N	Motion detection speed value	FP64	Command unit /s	100	When the current speed is greater than the set value, M20002+50*N is set to on
SFD8136+300*N	Motion detection filter	INT16U	ms	10	Filtering of motion detection, that is, after the detection speed is greater than the set value and lasts for the detection filtering time, the motion flag position is on. Max value is 10000
SFD8137+300*N	Speed warning percentage	INT16U	-	100	Not support at the moment
SFD8138+300*N	Acceleration warning percentage	INT16U	-	100	Not support at the moment
SFD8139+300*N	Deceleration warning percentage	INT16U	-	100	Not support at the moment

Homing configuration parameters

Address	Definition	Data type	Unit	Initial value	Note
SFD8160+300*N	Origin port	INT16U		177777	Origin signal input terminal number
SFD8161+300*N	Origin port polarity	ENUM		0	0-high level is 1 1-low level is 1
SFD8162+300*N	Near point port	INT16U		177777	Near point signal input terminal number. Not support at the moment
SFD8163+300*N	Near point port polarity	ENUM		0	Not support at the moment
SFD8164+300*N	Z-phase port	INT16U		177777	Z-phase signal input terminal
SFD8165+300*N	Z-phase port polarity	ENUM		0	0-high level is 1 1-low level is 1
SFD8166+300*N	Z-phase numbers	INT16U		0	Number of z-phase signals to be detected at the origin
SFD8168+300*N	Homing high speed	FP64	Command unit /s	0	
SFD8172+300*N	Homing creep speed	FP64	Command unit /s	0	The value needs to be smaller than homing high speed and larger than 0
SFD8176+300*N	Homing acceleration speed	FP64	Command unit/s ²	0	
SFD8180+300*N	Homing deceleration speed	FP64	Command unit /s ²	0	
SFD8184+300*N	Homing jerk speed	FP64	Command unit /s ³	0	
SFD8188+300*N	Zero point position	FP64	Command unit	0	The position set after the homing action is completed
SFD8192+300*N	Homing direction	ENUM		0	The direction when the homing action starts 0-forward

Address	Definition	Data type	Unit	Initial value	Note
					1-reverse

Pulse configuration parameters

Address	Definition	Data type	Unit	Initial value	Note
SFD8200+300*N	Pulse port	INT16U		177777	Pulse output terminal
SFD8201+300*N	Pulse direction port	INT16U		177777	Pulse direction output terminal
SFD8202+300*N	Pulse port polarity	ENUM		0	0-polarity does not reverse 1-polarity reversed
SFD8203+300*N	Pulse direction port polarity	ENUM		0	0-polarity does not reverse 1-polarity reversed

Closed-loop configuration parameters

Address	Definition	Data type	Unit	Initial value	Note
SFD8204+300*N	Closed-loop switch	ENUM		0	Closed loop function switch 0: OFF 1: ON
SFD8205+300*N	Closed loop feedback data source type	ENUM		0	Closed loop position feedback source 0: bus position feedback 1: high speed count. The high speed count terminal is set through SFD8006+300*N
SFD8206+300*N	Encoder equivalent	FP64		0	It only takes effect when the closed-loop position feedback source is high-speed counting. The encoder inputs the movement of each pulse. That is, the movement per turn (SFD8008 + 300*N) / encoder pulse numbers per turn. For example, the movement amount per revolution set by PLC is 10000, the closed-loop position feedback source is grating ruler or encoder counting, and the high-speed counting value of motor per revolution is 2500. Then the encoder equivalent value is set to 4.
SFD8210+300*N	Proportional gain	FP64		0	Proportional gain of PID in full closed loop control
SFD8214+300*N	Integral gain	FP64		0	Integral gain of PID in full closed loop control
SFD8218+300*N	Differential gain	FP64		0	Differential gain of PID in full closed loop control
SFD8222+300*N	Speed feedforward gain	FP64		0	Full closed loop speed feedforward gain
SFD8226+300*N	Feedback speed feedforward gain	FP64		0	Full closed loop speed feedback gain
SFD8230+300*N	Closed loop maximum position gain	FP64		0	Error code 2018 is returned when the closed-loop position deviation exceeds this limit value. When set to 0, it does not

Address	Definition	Data type	Unit	Initial value	Note
					take effect.
SFD8234+300*N	Speed forward looking filtering time	INT16U		0	Full closed loop speed feedforward filtering time
SFD8235+300*N	Feedback velocity filtering time	INT16U		0	Full closed loop speed feedback filtering time
SFD8236+300*N	2 degree free alpha	FP64		0	Full closed loop 2 free degree alpha. The range is 0 ~ 1. When the setting value is 0, instruction filtering is not performed. When the setting value is greater than 1, it is processed as 1.
SFD8240+300*N	2 degree free integral time	FP64		0	Full closed loop 2 free degree integration time.

Axis state coil (coil start address is decided by SFD814)

Address	Definition	Note
M20000+50*N	Axis enable	ON: axis enable state
M20001+50*N	Axis error	ON: axis error state
M20002+50*N	Axis motion	ON: the axis is in motion, the current speed of the axis is greater than the motion speed detection value and exceeds the motion detection filtering time, and the end of the motion is set to off
M20003+50*N	At the position	ON: the command movement is completed, and the deviation between the given and feedback is within the positioning completion width
M20004+50*N	At the origin	ON: the axis is within the electrical origin range
M20005+50*N	Speed warning	Not support at the moment
M20006+50*N	Acceleration warning	Not support at the moment
M20007+50*N	Deceleration warning	Not support at the moment
M20008+50*N	Axis motion completion	ON: command movement completion

Axis state register (register start address is decided by SFD816)

Address	Definition	Data type	Unit	Note
D20000+200*N	Axis state	INT16U	-	0: axis disable 1: axis enabled, not move 2: axis in motion (end speed is 0, include A_HALT) 3: axis in continuous motion 4: axis in synchronous motion 5: axis in homing 6: axis in deceleration stop (A_STOP) 7: axis error 8: the axis is in axis group motion
D20001+200*N	Error code	INT16U	-	Refer to the error code
D20008+200*N	Command given pulse	FP64	Pulse	Current given pulse of motion command
D20012+200*N	Command end position	FP64	Command unit	Target position of motion command
D20016+200*N	Axis given position	FP64	Command unit	Current given position of motion command
D20020+200*N	Axis given speed	FP64	Command	Current given speed of motion command

Address	Definition	Data type	Unit	Note
			unit /s	
D20024+200*N	Axis given acceleration/deceleration	FP64	Command unit /s ²	Current given acceleration and deceleration of motion command
D20040+200*N	Axis feedback pulse	FP64	Pulse	Axis actual motion pulse
D20044+200*N	Axis feedback position	FP64	Command unit	Axis actual motion position
D20048+200*N	Axis feedback speed	FP64	Command unit /s	Axis actual motion speed

5-2. Axis group function

5-2-1. Command list

Command	Function	Chapter
G PWR	Axis group enable	5-2-2-1
G CFGAXIS	Modify the composition axis	5-2-2-2
G PTP	point-to-point motion	5-2-2-3
G LINE	Linear interpolation	5-2-2-4
G CIRCLE	Arc interpolation	5-2-2-5
G HELICAL	Spiral motion	5-2-2-6
G MOVSUP	Superimposed motion	5-2-2-7
G COMPON	Compensation motion	5-2-2-8
G COMPOFF	Cancel compensation	5-2-2-9
G INTR	Interrupt the motion	5-2-2-10
G GOON	Continue the motion	5-2-2-11
G PATHMODE	Specify path mode selection	5-2-2-12
G PATHSEL	Select machining path	5-2-2-13
G PATHMOV	Path motion	5-2-2-14
G SETOVRD	Modify magnification	5-2-2-15

5-2-2. Command introduction

5-2-2-1. Axis group enable 【G_PWR】

(1) overview

turn on the axis group enable, make the axis group in operation state.

Axis group enable [G_PWR]			
Execution condition	Normally ON/OFF coil	Suitable model	XDH, XLH
Firmware	V3.6.1b and above	Software	3.7.4 and above

(2) operand

Operand	Function	Type
S0	Specify the output state word start address	16-bit, single word
S1	Specify the output state bit start address	Bit
S2	Specify axis group number	16-bit, single word

(3) Suitable soft component

Operand	Word soft component								Bit soft component										
	System								Constant	Module		System							
	D*	FD	TD*	CD*	DX	DY	DM*	DS*	K/H	ID	QD	X	Y	M*	S*	T*	C*		
S0	●	●	●	●	●	●	●	●											
S1														●					
S2									●										

*: D means D, HD; TD means TD and HTD; CD means CD, HCD, HSCD and HSD; DM means DM and DHM; DS means DS and DHS; M means M, HM, SM; S means S, HS; T means T, HT; C means C, HC.

(4) Function and action

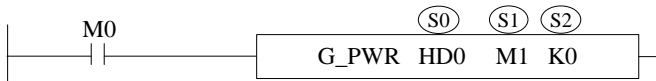

- S0 specifies output state word start address
- S1 specifies output state bit start address
- S2 specifies axis group number, starts from 0. The axis number in the axis group is set through $SFD48001+300*N \sim SFD48006+300*N$, N is axis group number.
- When M0 is set to on, enable the S2 specified axis group and switch the axis group to the operable state. Relevant axis group commands can be used only after the axis group is enabled
- After the command is executed, the single axis state of axis group ($D20000+200*N$) is 8, axis group state ($D46000+300*N$) is 1

(5) Notes

- Enabling the axis group requires that each single axis in the axis group is in the enabled state and the axis is in the unbound state
- After the axis group is enabled, the single axis specified by the axis group will not be able to use the single axis command
- The single axis number specified by the axis group cannot be repeated, the axis communication channels are consistent, the axis is in CSP mode, does not support encoder axis, and virtual axis can be set.

(6) Related parameters

Output parameter	Parameter name	Data type	Unit	Note
S0	ErrCode	INT16U	-	Command error code
State parameter	Parameter name	Data type	Unit	Note
S1	PwrStat	BOOL	-	Axis group enable state
Axis number	Parameter name	Data type	Unit	Note
S2	Axis	INT16U	-	Axis group number starts from 0

(7) Sequence diagram



(8) Application

For example, the axis group consists of axis 0, axis 1 and axis 2. It is required to enable the axis group. The ladder diagram is as follows:

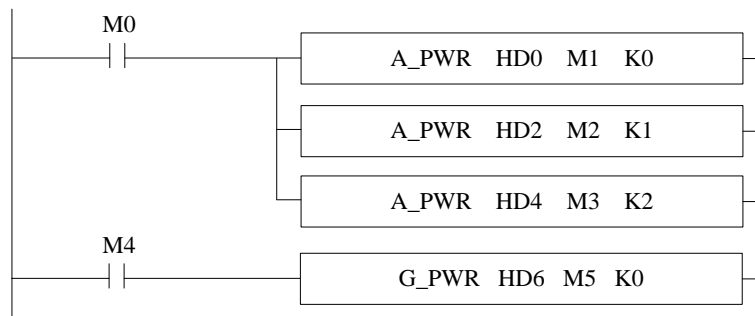

Axis group configurations:

Basic configuration	Performance parameter configuration	Alarm parameter configuration	Limit the configuration	Interpolation configuration	Looking forward to parameter
<input type="checkbox"/> Parameter names	address	Offline values	Online value	type	Parameter effec... instructions
<input type="checkbox"/> Kinematic type	SFD48000	XYZ	XYZ	ENUM	Power back on
<input checked="" type="checkbox"/> Configure axi...	SFD48001	0	0	INT16U	Power back on Uniaxial number match, 65535 is invalid
<input checked="" type="checkbox"/> Configure axi...	SFD48002	1	1	INT16U	Power back on Uniaxial number match, 65535 is invalid
<input checked="" type="checkbox"/> Configure axi...	SFD48003	2	2	INT16U	Power back on Uniaxial number match, 65535 is invalid
<input type="checkbox"/> Configure axi...	SFD48004	65535	65535	INT16U	Power back on Uniaxial number match, 65535 is invalid
<input type="checkbox"/> Configure axi...	SFD48005	65535	65535	INT16U	Power back on Uniaxial number match, 65535 is invalid
<input type="checkbox"/> Configure axi...	SFD48006	65535	65535	INT16U	Power back on Uniaxial number match, 65535 is invalid
<input type="checkbox"/> Axis group er...	SFD48007	Is not enabled	Is not enabled	ENUM	Power back on
<input type="checkbox"/> Stop mode	SFD48008	Given to stop	Given to stop	ENUM	Power back on 0: Given stop, the given position is unchanged when trig

The constituent axes of axis group 0 are set through SFD48001, SFD48002 and SFD48003. The axis group can be enabled only after all constituent axes of the axis group are enabled. After the axis group is enabled, the corresponding axis group state machine D46000 + 300*N changes to 1, indicating that the axis group is enabled. The single axis state machine D20000 + 200*N of the axis group changes to 8, indicating that the axis is in the axis group. Refer to chapter 5-1-3 for single axis related registers and 5-2-3 for axis group related registers.

寄存器	监控值	字长	进制	注释
D20000	8	单...	1...	轴0状态机
D20200	8	单...	1...	轴1状态机
D20400	8	单...	1...	轴2状态机
D46000	1	单...	1...	轴组状态机

5-2-2-2. Modify the composition axis 【G_CFGAXIS】

(1) Overview

Modify the composition axis of the axis group.

Modify the composition axis [G_CFGAXIS]			
Execution condition	Rising/falling edge of the coil	Suitable model	XDH, XLH
Firmware	V3.6.1b and above	Software	3.7.4 and above

(2) operand

Operand	Function	Type
S0	Specify the input parameter start address	16-bit, single word
S1	Specify the output state word start address	16-bit, single word
S2	Specify the output state bit start address	Bit
S3	Specify axis group number	16-bit, single word

(3) Suitable soft component

Operand	Word soft component								Bit soft component										
	System								Constant	Module		System							
	D*	FD	TD*	CD*	DX	DY	DM*	DS*	K/H	ID	QD	X	Y	M*	S*	T*	C*		
S0	●	●	●	●	●	●	●	●											
S1	●	●	●	●	●	●	●	●											
S2														●					
S3	●								●										

*: D means D, HD; TD means TD and HTD; CD means CD, HCD, HSCD and HSD; DM means DM and DHM; DS means DS and DHS; M means M, HM, SM; S means S, HS; T means T, HT; C means C, HC.

(4) Function and action



- S0 specifies the input parameter start address, occupies the register S0~S0+5
- S1 specifies the output state word start address
- S2 specifies the output state bit start address, occupies the relay S2~S2+3
- S3 specifies the axis group number
- When M0 is from off → on, S3 specifies the axis group and modifies the constituent axis of the axis group with the parameters set by the user

(5) Notes

- The constituent axis does not support encoder axis and duplicate axis number, and the communication channels of each axis of the axis group need to be consistent
- The axis group is in motion and cannot perform G_CFGAXIS
- The constituent axis cannot be the same as the axis number in other enabled axis groups
- The modified composition axis will be restored after PLC stop and power failure.

(6) Related parameters

Input parameter	Parameter name	Data type	Unit	Note
S0	AxisX	INT16U		X axis composition axis number
S0+1	AxisY	INT16U		Y axis composition axis number
S0+2	AxisZ	INT16U		Z axis composition axis number
S0+3	AxisA	INT16U		A axis composition axis number
S0+4	AxisB	INT16U		B axis composition axis number

S0+5	AxisC	INT16U		C axis composition axis number
Output parameter	Parameter name	Data type	Unit	Note
S1	ErrCode	INT16U	-	Command error code
State parameter	Parameter name	Data type	Unit	Note
S2	Done	BOOL		Instruction execution completed
S2+1	Busy	BOOL		The instruction is being executed
S2+2	Abort	BOOL		Instruction is interrupted
S2+3	Error	BOOL		Instruction execution error
Axis number	Parameter name	Data type	Unit	Note
S3	Axis	INT16U		Axis group number starts from 0

(7) Sequence diagram

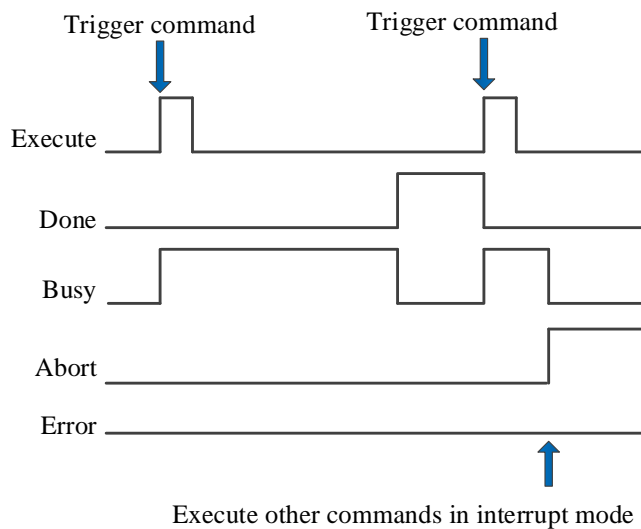

Explanation:

Generally, after the command is triggered, the Busy signal is set, reset after the command is executed, and the Done signal is set. Done is reset only after the command is triggered again, otherwise it will not be reset automatically.

When the instruction is interrupted or has an error, the corresponding Abort or Error signal is set, other signals are reset, and the corresponding error code will be output in case of error.

5-2-2-3. Point to point motion 【G_PTP】

(1) Overview

Each axis runs to the target position at the fastest speed.

Point to point motion [G_PTP]			
Execution condition	Rising/falling edge of the coil	Suitable model	XDH, XLH
Firmware	V3.6.1b and above	Software	3.7.4 and above

(2) operand

Operand	Function	Type
S0	Specify the input parameter start address	64-bit, four words
S1	Specify the output state word start address	16-bit, single word
S2	Specify the output state bit start address	Bit
S3	Specify axis group number	16-bit, single word

(3) Suitable soft component

Operand	Word soft component								Bit soft component								
	System								Constant	Module		System					
	D*	FD	TD*	CD*	DX	DY	DM*	DS*	K/H	ID	QD	X	Y	M*	S*	T*	C*
S0	●	●	●	●	●	●	●	●									
S1	●	●	●	●	●	●	●	●									
S2														●			
S3	●								●								

*: D means D, HD; TD means TD and HTD; CD means CD, HCD, HSCD and HSD; DM means DM and DHM; DS means DS and DHS; M means M, HM, SM; S means S, HS; T means T, HT; C means C, HC.

(4) Function and action



- S0 specifies the input parameter start address, occupies the register S0~S0+31
- S1 specifies the output state word start address
- S2 specifies output state bit start address, occupies the relay S2~S2+4
- S3 specifies the axis group number
- When M0 changes from off → on, each axis of the axis group reaches the target position at the fastest speed, and the speed uses the default speed configuration of single axis. The axis speed = max speed (SFD8080+300*N)*default speed percentage (SFD8096+300*N).
- After executing the command, the single axis state of axis group (D20000+200*N) is 8, axis group state (D46000+300*N) is 2.

(5) Notes

- When the G_PTP command is executed, each axis in its axis group is separated and moves to the target position with its own track
- The instruction supports buffer. At most one instruction can be cached. When the instruction is executed in buffer mode, it will wait for all axes in the current axis group to finish moving before executing the cached instruction.

(6) Related parameters

Input parameter	Parameter name	Data type	Unit	Note
S0	PositionX	FP64	Command unit	X axis position. X axis number is set through SFD48001+300*N.
S0+4	PositionY	FP64	Command unit	Y axis position. Y axis number is set through SFD48002+300*N.

S0+8	PositionZ	FP64	Command unit	Z axis position. Z axis number is set through SFD48003+300*N.
S0+12	PositionA	FP64	Command unit	A axis position. Not supported at the moment.
S0+16	PositionB	FP64	Command unit	B axis position. Not supported at the moment.
S0+20	PositionC	FP64	Command unit	C axis position. Not supported at the moment.
S0+24	Coordinate	INT16U	-	Coordinate system. Not supported at the moment.
S0+25	Buffermode	INT16U	-	Buffer mode 0: interrupt mode 1: buffer mode
S0+26	TransitionMode	INT16U	-	Transition mode. Not supported at the moment
S0+28	TransitionVel	FP64	-	Transition speed.
Output parameter	Parameter name	Data type	Unit	Note
S1	ErrCode	INT16U	-	Command error code
State parameter	Parameter name	Data type	Unit	Note
S2	Done	BOOL	-	Instruction execution completed
S2+1	Busy	BOOL	-	The instruction is being executed
S2+2	Active	BOOL	-	Command under control
S2+3	Abort	BOOL	-	Instruction is interrupted
S2+4	Error	BOOL	-	Instruction execution error
Axis number	Parameter name	Data type	Unit	Note
S3	Axis	INT16U	-	Axis group number starts from 0

(7) Sequence diagram

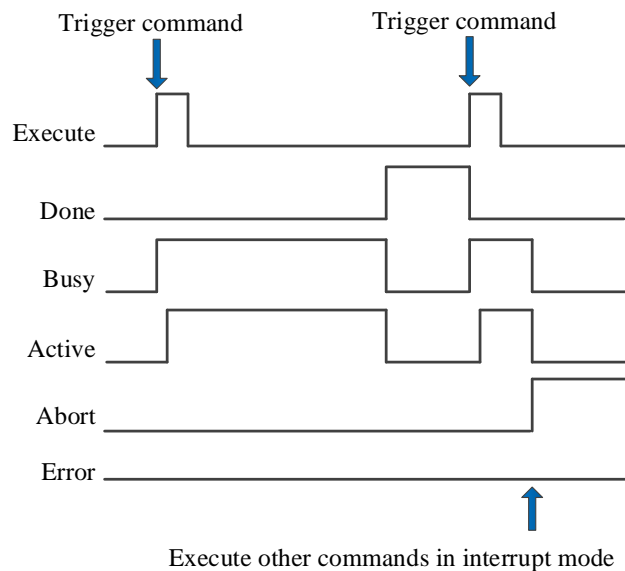

Explanation:

Generally, after the command is triggered, the Busy and Active signals are set, and reset after the command is executed. At the same time, the Done signal is set. Done will reset only after the command is triggered again, otherwise it will not reset automatically.

When the instruction is triggered in the buffer mode and there are currently instructions being executed, the Active signal will be set immediately. The execution of the current instruction ends. When the instruction is executed, the Busy signal will be set. After the execution of the instruction ends, the Busy and Active signals will be reset and

the Done signal will be set.

When a new instruction is triggered in interrupt mode during instruction execution, the Busy and Active signals are reset immediately and the Abort signal is set.

When there is an error in the command, the Error signal is set, other signals are reset, and the corresponding error code is output.

(8) Application

For example, it requires the axis group moves to the point (10000,0,0) with command G_PTP. The ladder chart is shown as below:

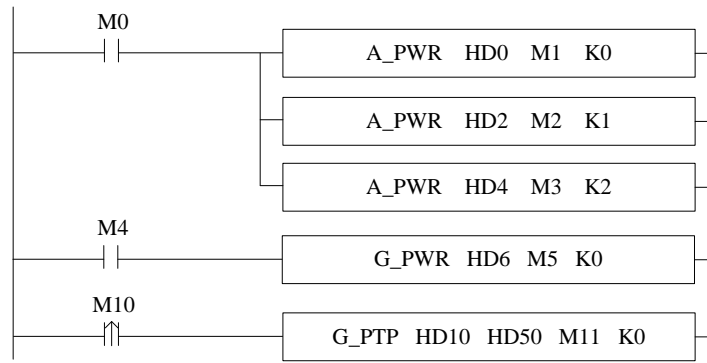

The instruction configuration:

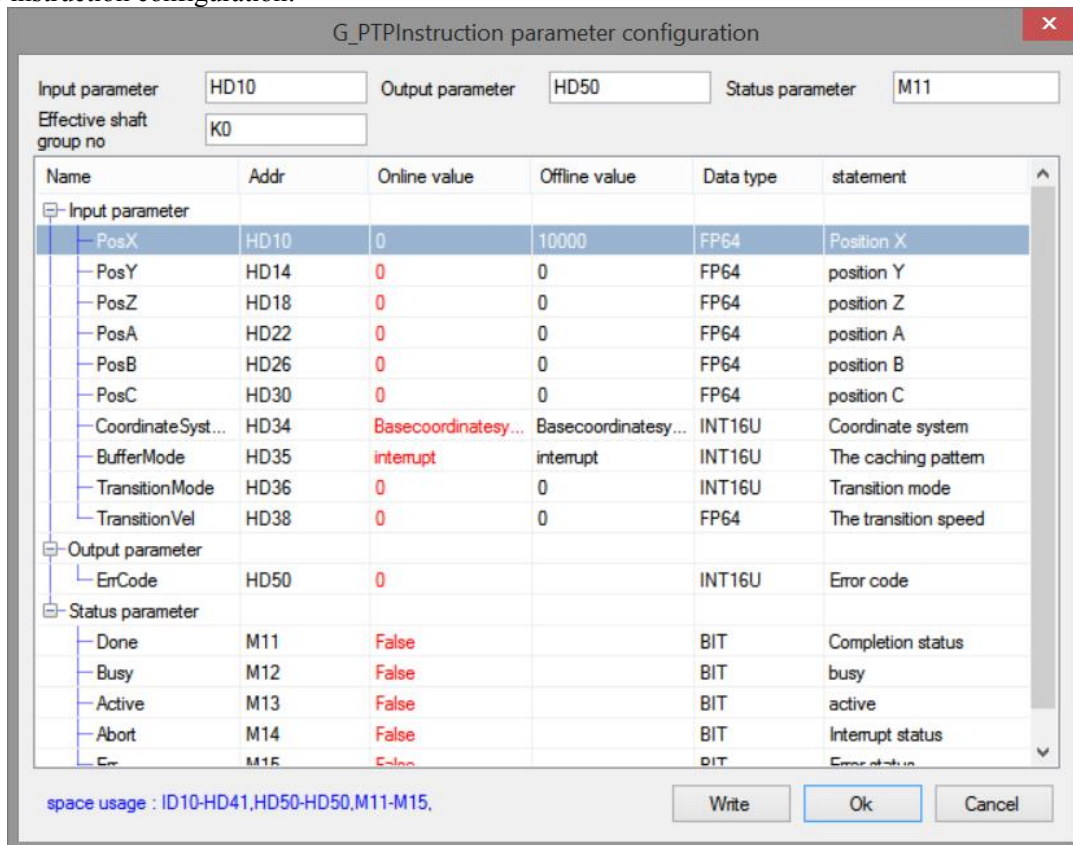

Explanation:

The relevant axis group movement command can be executed only after the axis group is enabled. The axis group enabling requires each component axis to be enabled first. Refer to chapter 5-2-2-1 command G_PWR for details. G_PTP command runs to the specified point at the default speed of each constituent axis.

The default speed = max speed (SFD8080+300*N) * default speed percentage (SFD8096+300*N). Please refer to chapter 5-1-3 for the parameter details.

Basic configuration	Probe configuration	Limit the configuration	Performance configuration	Detection and alarm configuration	Return to origin configuration	Pulse configuration	A closed-loop configuration
<input type="checkbox"/>	Parameter names	address	Offline values	Online value	type	Parameter effec...	instructions
<input type="checkbox"/>	The highest s...	SFD8080	100000	100000	FP64	Power back on	
<input type="checkbox"/>	Maximum acc...	SFD8084	1000000	1000000	FP64	Power back on	
<input type="checkbox"/>	Maximum decel...	SFD8088	1000000	1000000	FP64	Power back on	
<input type="checkbox"/>	Maximum acc...	SFD8092	10000000	10000000	FP64	Power back on	
<input type="checkbox"/>	Default speed...	SFD8096	10	10	INT16U	Power back on	
<input type="checkbox"/>	Default accel...	SFD8097	10	10	INT16U	Power back on	
<input type="checkbox"/>	Default decel...	SFD8098	10	10	INT16U	Power back on	
<input type="checkbox"/>	The default ra...	SFD8099	10	10	INT16U	Power back on	

As the above figure, the default speed=100000 (max speed) *10% (default speed percentage) =10000. If the maximum speed of the single axis is set low, the axis group will calculate the linear speed according to the maximum speed of the single axis, so that the linear speed of the axis group cannot reach the target speed set in the command.

Its running track is as follows (taking XY axis as an example):

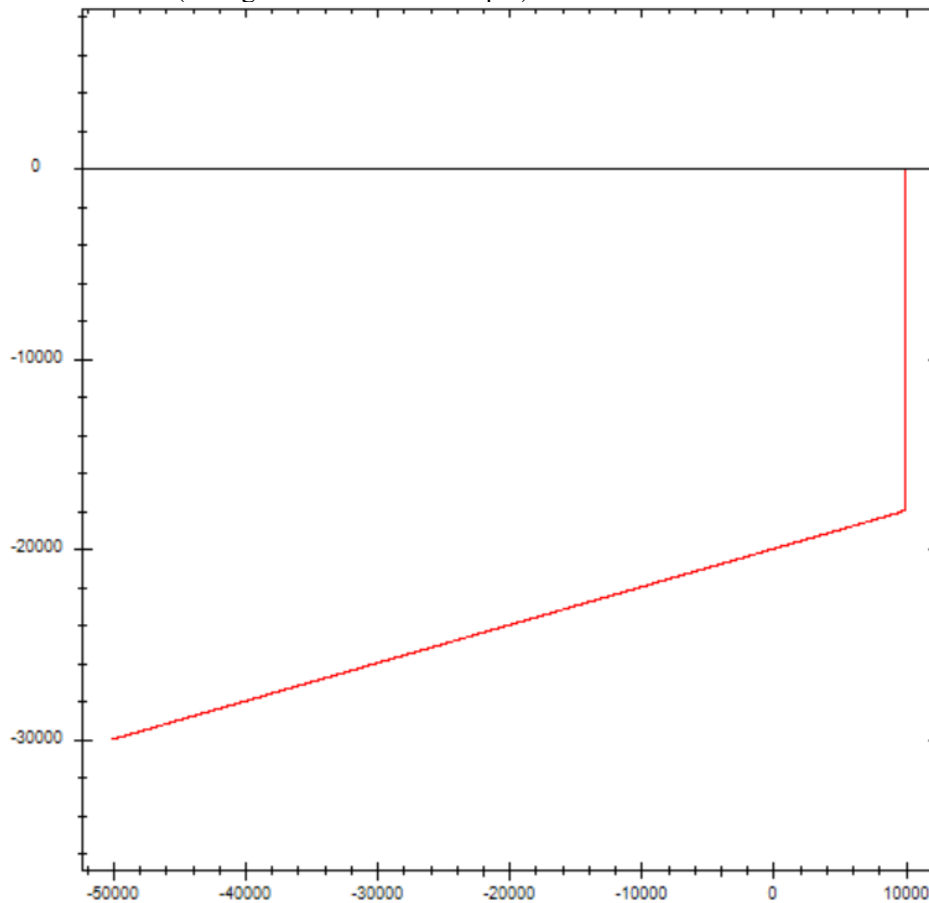

In the figure, the abscissa is X axis and the ordinate is Y axis. Coordinate starting point (- 50000, - 30000), after G_PTP motion, the X and Y axes move to the target position (10000,0) at their respective default speeds.

5-2-2-4. Linear interpolation 【G_LINE】

(1) Overview

The axis group performs spatial linear motion with the set parameters.

Linear interpolation [G_LINE]			
Execution condition	Rising/falling edge of the coil	Suitable model	XDH, XLH
Firmware	V3.6.1b and above	Software	3.7.4 and above

(2) operand

Operand	Function	Type
S0	Specify the input parameter start address	64-bit, four words
S1	Specify the output state word start address	16-bit, single word
S2	Specify the output state bit start address	Bit
S3	Specify axis group number	16-bit, single word

(3) Suitable soft component

Operand	Word soft component								Bit soft component								
	System								Constant	Module		System					
	D*	FD	TD*	CD*	DX	DY	DM*	DS*	K/H	ID	QD	X	Y	M*	S*	T*	C*
S0	●	●	●	●	●	●	●	●									
S1	●	●	●	●	●	●	●	●									
S2														●			
S3	●								●								

*: D means D, HD; TD means TD and HTD; CD means CD, HCD, HSCD and HSD; DM means DM and DHM; DS means DS and DHS; M means M, HM, SM; S means S, HS; T means T, HT; C means C, HC.

(4) Function and action



- S0 specifies the input parameter start address, occupies the register S0~S0+51
- S1 specifies the output state word start address
- S2 specifies output state bit start address, occupies the relay S2~S2+4
- S3 specifies the axis group number
- When M0 changes from off → on, the axis group specified by S3 performs linear interpolation at the speed, acceleration/deceleration and jerk speed set by the user
- After the command is executed, single axis state of axis group (D20000+200*N) is 8, axis group state (D46000+300*N) is 2.

(5) Related parameters

Input parameter	Parameter name	Data type	Unit	Note
S0	PositionX	FP64	Command unit	X axis position. X axis number is set through SFD48001+300*N
S0+4	PositionY	FP64	Command unit	Y axis position. Y axis number is set through SFD48002+300*N
S0+8	PositionZ	FP64	Command unit	Z axis position. Z axis number is set through SFD48003+300*N
S0+12	PositionA	FP64	Command unit	A axis position. Not supported at the moment
S0+16	PositionB	FP64	Command unit	B axis position. Not supported at the moment
S0+20	PositionC	FP64	Command unit	C axis position. Not supported at the moment

Input parameter	Parameter name	Data type	Unit	Note
S0+24	Velocity	FP64	Command unit /s	Target speed
S0+28	Acceleration	FP64	Command unit /s ²	Target acceleration speed
S0+32	Deceleration	FP64	Command unit /s ²	Target deceleration speed
S0+36	Jerk	FP64	Command unit /s ³	Target jerk speed, the change rate of acceleration/deceleration
S0+40	Coordinate	INT16U	-	Coordinate system. Not supported at the moment
S0+41	Buffermode	INT16U	-	Buffer mode 0: interrupt mode 1: buffer mode
S0+42	TransitionMode	INT16U	-	Transition method (currently only speed transition is supported) 0: speed transition
S0+44	Endvel	FP64	Command unit /s	End speed. Not supported at the moment
S0+48	TransitionVel	FP64	Command unit /s	Transition speed
Output parameter	Parameter name	Data type	Unit	Note
S1	ErrCode	INT16U	-	Command error code
State parameter	Parameter name	Data type	Unit	Note
S2	Done	BOOL	-	Instruction execution completed
S2+1	Busy	BOOL	-	The instruction is being executed
S2+2	Active	BOOL	-	Command under control
S2+3	Abort	BOOL	-	Instruction is interrupted
S2+4	Error	BOOL	-	Instruction execution error
Axis number	Parameter name	Data type	Unit	Note
S3	Axis	INT16U	-	Axis group number starts from 0

- The relationship between acceleration, deceleration and jerk speed is the same as A_MOVEA instruction, see relevant parameters in chapter 5-1-2-7 (5) for details.
- The speed, acceleration/deceleration and jerk speed parameters set by the user are all parameters of the axis group. If the parameter set by the user is greater than the maximum parameter value of the axis group, it will be treated as the maximum parameter value of the axis group. If the parameter value set by the user is greater than the maximum parameter value of each single axis, the linear speed and other parameters of the axis group will be calculated based on the maximum parameter value of the single axis.
- The trajectory of G_LINE is a straight line in space, and its acceleration and deceleration parameters are the acceleration and deceleration of axis group, which is independent of the speed direction of each single axis.
- Support buffer instruction. When the buffer mode is set to 0, the instruction will interrupt the axis group instruction in the current motion and execute a new instruction immediately. When the buffer mode is set to 1, the instruction will enter the buffer area and wait for the execution of the currently moving instruction to end before executing a new instruction. If the buffer is full, the buffer cannot be cached and error code 5011 is returned.
- If the acceleration, deceleration and jerk speed entered by the user are 0, the default values of the axis group will be used:
Acceleration speed = XYZ max acceleration (SFD48024+300*N) *XYZ default acceleration percentage (SFD48053+300*N)
Deceleration speed = XYZ max deceleration (SFD48028+300*N) *XYZ default deceleration percentage (SFD48054+300*N)
Jerk speed = XYZ max jerk speed (SFD48032+300*N) *XYZ default jerk speed percentage (SFD48055+300*N)
N is axis group number.

- The transition speed parameter is only valid in the buffer mode when there are instructions in the buffer area (the cached instructions cannot be G_PTP, and the currently executed instructions cannot be G_PTP). When the moving instructions reach the deceleration stage and the speed is less than the transition speed, the cached instructions will be triggered automatically, so there will be deviation from the specified track. The greater the transition speed, the smoother the inflection point between the two lines.

(6) Sequence diagram

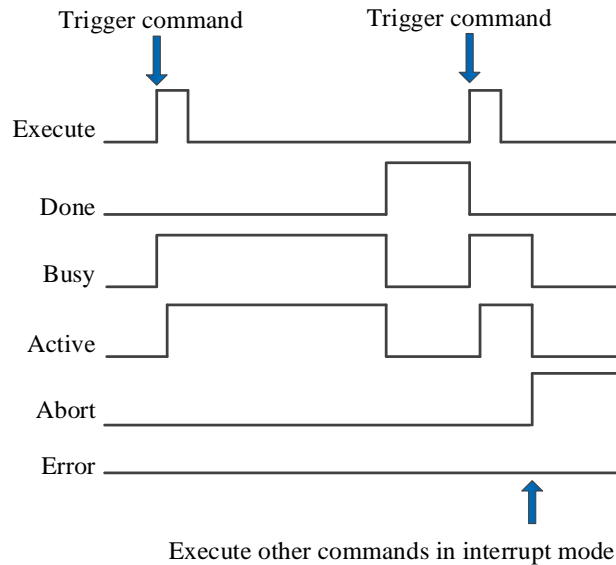

Explanation:

Generally, after the command is triggered, the Busy and Active signals are set, and reset after the command is executed. At the same time, the Done signal is set. Done will reset only after the command is triggered again, otherwise it will not reset automatically.

When the instruction is triggered in the buffer mode and there are currently instructions being executed, the Active signal will be set immediately. The execution of the current instruction ends. When the instruction is executed, the Busy signal will be set. After the execution of the instruction ends, the Busy and Active signals will be reset and the Done signal will be set.

When a new instruction is triggered in interrupt mode during instruction execution, the Busy and Active signals are reset immediately and the Abort signal is set.

When there is an error in the command, the Error signal is set, other signals are reset, and the corresponding error code is output.

(7) Application

- ① ladder chart:

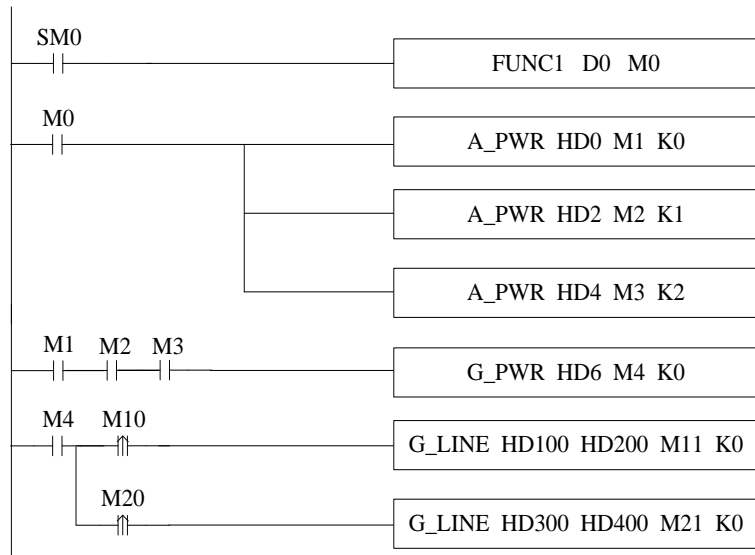

Among them, FUNC1 function block is used to set value for G_LINE command, M0 turns on the enabling of each axis. When all three axes enabling are turned on (flag bits M1, M2 and M3 are on), turn on the axis group enabling. After the axis group is enabled (the flag M4 is on), execute the first G_LINE command when M10 is set to on, execute the second G_LINE command when M20 is set to on.

②_set value for command G_LINE (right click the command to set the value, or set value through C program):

```

9 void FUNC1( WORD W , BIT B )
10 {
11 #define SysRegAddr_HD_D_HM_M
12 #define DFHD *(FP64*)&HD //DFHD represents a double precision floating-point number HD register
13
14 //the first G_LINE command value setting
15 DFHD[100] = 100000;//command position X
16 DFHD[104] = 200000;//command position Y
17 DFHD[124] = 20000;//command speed
18 DFHD[128] = 100000;//command acceleration
19 DFHD[132] = 100000;//command deceleration
20 DFHD[136] = 200000;//command jerk speed
21 HD[141] = 0;//command buffer mode
22 DFHD[148] = 0;//command transition speed
23
24 //second G-LINE command value setting
25 DFHD[300] = 200000;//command position X
26 DFHD[304] = 0;//command position Y
27 DFHD[324] = 20000;//command speed
28 DFHD[328] = 100000;//command acceleration
29 DFHD[332] = 100000;//command deceleration
30 DFHD[336] = 200000;//command jerk speed
31 HD[341] = 1;//command buffer mode
32 DFHD[348] = 0;//command transition speed
33 }
34

```

The instruction demonstrated in this example is the linear interpolation of XY axis (the axis group type only supports XYZ type, and the axis group of XY axis can be realized by setting the corresponding axis configuration of Z axis as virtual axis). The movement amount of X and Y axes per cycle is 10000. The axis group can run to (100000, 200000) at the speed of 20000 command unit/s by setting values to the parameters as shown in the figure and turning on M10 and M20 in turn. Then run to the position (20000,0) at the speed of 20000 command unit/s.

③ The operation track of the axis group is shown in the figure below (where the x-axis position is the abscissa and the y-axis position is the ordinate):

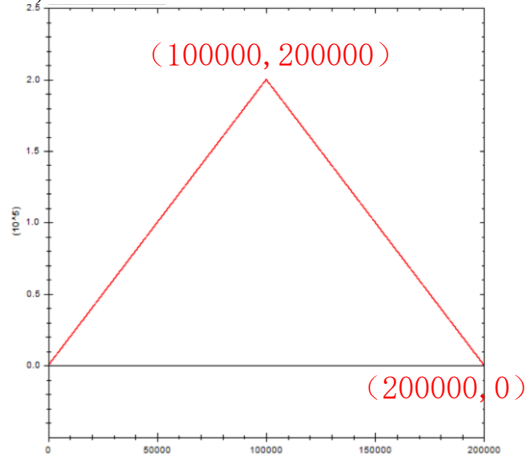

When the transition speed of the second command is set to different values, the effect is as follows:

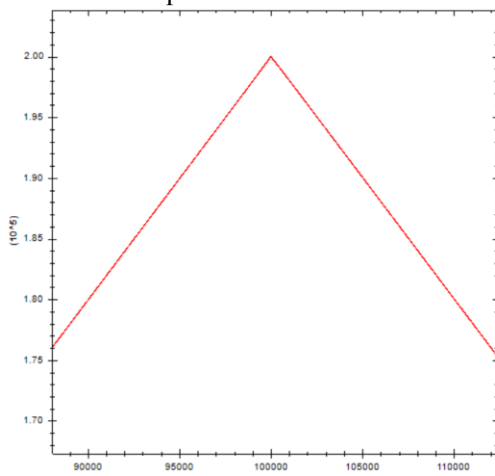

transition speed = 0

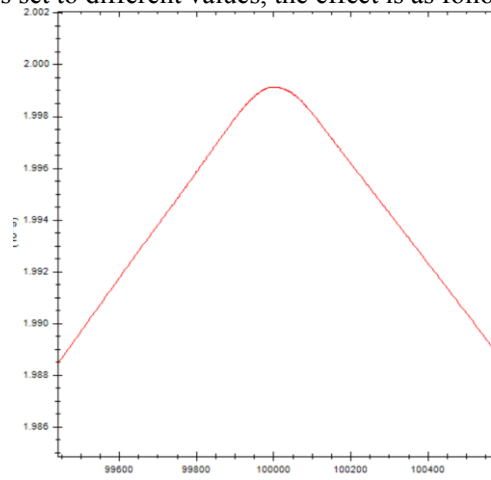

transition speed = 5000

5-2-2-5. Circular interpolation 【G_CIRCLE】

(1) Overview

The axis group performs spatial arc motion with the set parameters.

Circular interpolation [G_CIRCLE]			
Execution condition	Rising/falling edge of the coil	Suitable model	XDH, XLH
Firmware	V3.6.1b and above	Software	3.7.4 and above

(2) operand

Operand	Function	Type
S0	Specify the input parameter start address	64-bit, four words
S1	Specify the output state word start address	16-bit, single word
S2	Specify the output state bit start address	Bit
S3	Specify axis group number	16-bit, single word

(3) Suitable soft component

Operand	Word soft component								Bit soft component								
	System								Constant	Module		System					
	D*	FD	TD*	CD*	DX	DY	DM*	DS*	K/H	ID	QD	X	Y	M*	S*	T*	C*
S0	●	●	●	●	●	●	●	●									
S1	●	●	●	●	●	●	●	●									
S2														●			
S3	●								●								

*: D means D, HD; TD means TD and HTD; CD means CD, HCD, HSCD and HSD; DM means DM and DHM; DS means DS and DHS; M means M, HM, SM; S means S, HS; T means T, HT; C means C, HC.

(4) Function and action



- S0 specifies the input parameter start address, occupies the register S0~S0+79
- S1 specifies the output state word start address
- S2 specifies output state bit start address, occupies the relay S2~S2+4
- S3 specifies the axis group number
- When M0 changes from off → on, the axis group specified by S3 performs arc interpolation at the speed, acceleration/deceleration and jerk speed set by the user
- After the command is executed, the single axis state of axis group (D20000+200*N) is 8, the axis group state (D46000+300*N) is 2.

(5) Related parameters

Input parameter	Parameter name	Data type	Unit	Note
S0	Mode	INT16U	-	Arc mode (currently only three-point arc is supported) 0: three-point arc
S0+1	PathSelected	INT16U	-	Path selection. Not supported at the moment
S0+4	AuxiliaryX	FP64	Command unit	X axis auxiliary point position X axis number is set through SFD48001+300*N
S0+8	AuxiliaryY	FP64	Command unit	Y axis auxiliary point position Y axis number is set through SFD48002+300*N
S0+12	AuxiliaryZ	FP64	Command unit	Z axis auxiliary point position Z axis number is set through

Input parameter	Parameter name	Data type	Unit	Note
				SFD48003+300*N
S0+16	AuxiliaryA	FP64	Command unit	A axis auxiliary point position, not supported at the moment
S0+20	AuxiliaryB	FP64	Command unit	B axis auxiliary point position, not supported at the moment
S0+24	AuxiliaryC	FP64	Command unit	C axis auxiliary point position, not supported at the moment
S0+28	PositionX	FP64	Command unit	X axis target position. X axis number is set through SFD48001+300*N
S0+32	PositionY	FP64	Command unit	Y axis target position. Y axis number is set through SFD48002+300*N
S0+36	PositionZ	FP64	Command unit	Z axis target position. Z axis number is set through SFD48003+300*N
S0+40	PositionA	FP64	Command unit	A axis target position. Not supported at the moment
S0+44	PositionB	FP64	Command unit	B axis target position. Not supported at the moment
S0+48	PositionC	FP64	Command unit	C axis target position. Not supported at the moment
S0+52	Velocity	FP64	Command unit /s	Target speed
S0+56	Acceleration	FP64	Command unit /s ²	Target acceleration speed
S0+60	Deceleration	FP64	Command unit /s ²	Target deceleration speed
S0+64	Jerk	FP64	Command unit /s ²	Target jerk speed, the change rate of acceleration and deceleration
S0+68	Coordinate	INT16U	-	Coordinate system. Not supported at the moment
S0+69	Buffermode	INT16U	-	Buffer mode 0: interrupt mode 1: buffer mode
S0+70	TransitionMode	INT16U	-	Transition method (only support speed transition) 0: speed transition
S0+72	Endvel	FP64	Command unit /s	End speed. Not supported at the moment
S0+76	TransitionVel	FP64	Command speed/s	Transition speed
Output parameter	Parameter name	Data type	Unit	Note
S1	ErrCode	INT16U	-	Command error code
State parameter	Parameter name	Data type	Unit	Note
S2	Done	BOOL	-	Instruction execution completed
S2+1	Busy	BOOL	-	The instruction is being executed
S2+2	Active	BOOL	-	Command under control
S2+3	Abort	BOOL	-	Instruction is interrupted
S2+4	Error	BOOL	-	Instruction execution error
Axis number	Parameter name	Data type	Unit	Note
S3	Axis	INT16U	-	Axis group number starts from 0

- The relationship between acceleration, deceleration and jerk speed is the same as A_MOVEA instruction, see relevant parameters in chapter 5-1-2-7 (5) for details.
- The speed, acceleration/deceleration and jerk speed parameters set by the user are all parameters of the axis group. If the parameter set by the user is greater than the maximum parameter value of the axis group, it will be treated as the maximum parameter value of the axis group. If the parameter value set by the user is greater than the maximum parameter value of each single axis, the linear speed and other parameters of the axis group will be calculated based on the maximum parameter value of the single axis.
- The trajectory of G_CIECLE is a arc in space, and its acceleration and deceleration parameters are the acceleration and deceleration of axis group, which is independent of the speed direction of each single axis.
- The three points of the three-point arc are the current point, auxiliary point and end point respectively. The arc will pass through the auxiliary point and finally reach the end position. The three points cannot be on the same straight line and do not support the whole circle (that is, the current point and end point are the same point).
- Support buffer instruction. When the buffer mode is set to 0, the instruction will interrupt the axis group instruction in the current motion and execute a new instruction immediately. When the buffer mode is set to 1, the instruction will enter the buffer area and wait for the execution of the currently moving instruction to end before executing a new instruction. If the buffer is full, the buffer cannot be cached and error code 5011 is returned.
- If the acceleration, deceleration and jerk speed entered by the user are 0, the default values of the axis group will be used:
Acceleration speed = XYZ max acceleration (SFD48024+300*N) *XYZ default acceleration percentage (SFD48053+300*N)
Deceleration speed = XYZ max deceleration (SFD48028+300*N) *XYZ default deceleration percentage (SFD48054+300*N)
Jerk speed = XYZ max jerk speed (SFD48032+300*N) *XYZ default jerk speed percentage (SFD48055+300*N).
N is axis group number.
- The transition speed parameter is only valid in the buffer mode when there are instructions in the buffer area. When the moving instructions reach the deceleration stage and the speed is less than the transition speed, the cached instructions will be triggered automatically, so there will be deviation from the specified track. The greater the transition speed, the smoother the inflection point between the two curves.

(6) Sequence diagram

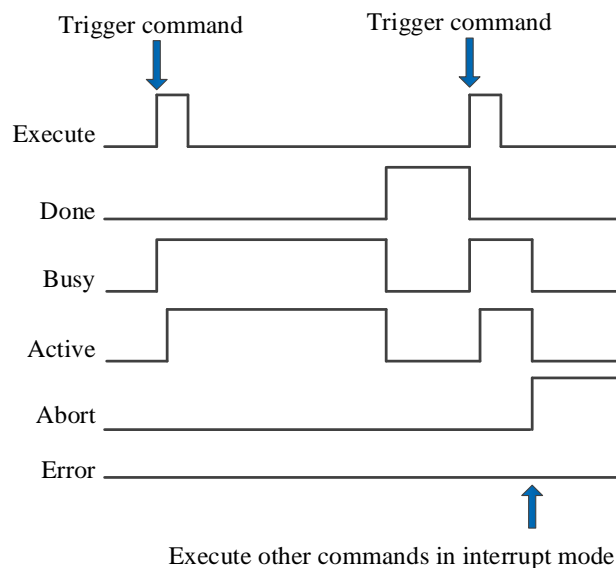

Explanation:

Generally, after the command is triggered, the Busy and Active signals are set, and reset after the command is executed. At the same time, the Done signal is set. Done will reset only after the command is triggered again, otherwise it will not reset automatically.

When the instruction is triggered in the buffer mode and there are currently instructions being executed, the Active signal will be set immediately. The execution of the current instruction ends. When the instruction is executed, the

Busy signal will be set. After the execution of the instruction ends, the Busy and Active signals will be reset and the Done signal will be set.

When a new instruction is triggered in interrupt mode during instruction execution, the Busy and Active signals are reset immediately and the Abort signal is set.

When there is an error in the command, the Error signal is set, other signals are reset, and the corresponding error code is output.

(7) Application

① ladder diagram

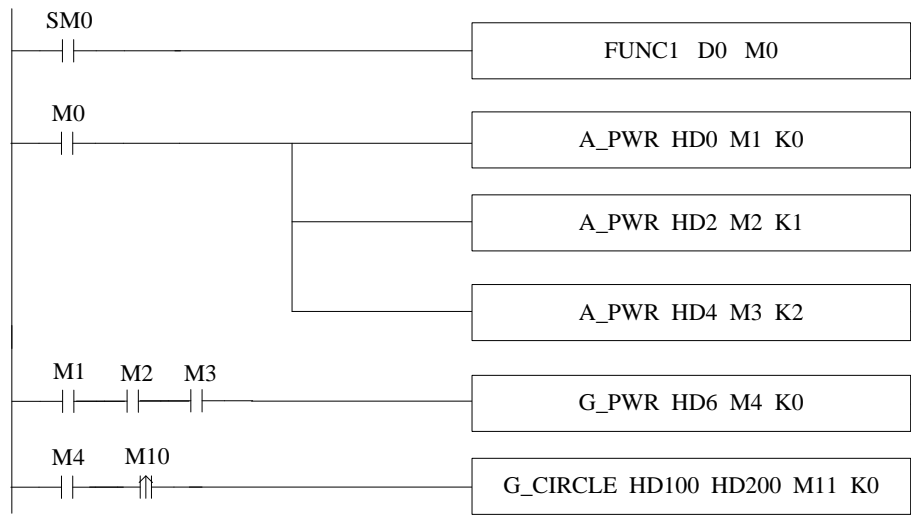

Among them, FUNC1 function block is used to set value for G_CIRCLE command, M0 turns on the enabling of each axis. When all three axes enabling are turned on (flag bits M1, M2 and M3 are on), turn on the axis group enabling. After the axis group is enabled (the flag M4 is on), when M10 is set to on, execute the G_CIRCLE command.

② set value for command G_CIRCLE (right click the command to set the value, or set value through C program):

```

9 void FUNC1( WORD W , BIT B )
10 {
11 #define SysRegAddr_HD_D_HM_M
12 #define DFHD *(FP64*)&HD //DFHD represents a double precision floating-point number HD register
13
14 //G_CIRCLE command value setting
15 DFHD[104] = 50000;//auxiliary position X
16 DFHD[108] = 25000;//auxiliary position Y
17 DFHD[128] = 100000;//target position X
18 DFHD[132] = 0;//target position Y
19 DFHD[152] = 20000;//command speed
20 DFHD[156] = 100000;//command acceleration
21 DFHD[160] = 100000;//command deceleration
22 DFHD[164] = 200000;//command jerk speed
--

```

The instruction demonstrated in this example is the circular arc interpolation of XY axis (the axis group type only supports XYZ type, and the axis group of XY axis can be realized by setting the corresponding axis configuration of Z axis as virtual axis). The movement of X and Y axes per cycle is 10000. The axis group can run at the speed of 20000 command units/s, passing through the auxiliary point (50000, 25000) to the end point (100000,0) by assigning values to the parameters as shown in the figure and set ON M10.

③ The operation track of the axis group is shown in the figure below (where the X-axis position is the abscissa and the Y-axis position is the ordinate):

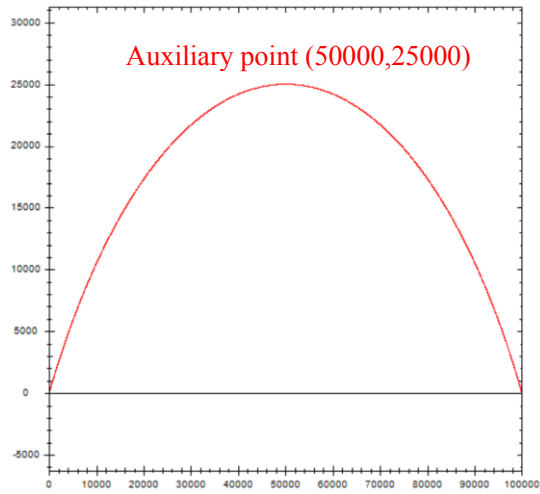

5-2-2-6. Spiral motion 【G_HELICAL】

(1) Overview

Performs spiral motion control on the specified axis group.

Spiral motion [G_HELICAL]			
Execution condition	Rising/falling edge of the coil	Suitable model	XDH, XLH
Firmware	V3.7.1 and above	Software	3.7.4 and above

(2) operand

Operand	Function	Type
S0	Specify the input parameter start address	64-bit, four words
S1	Specify the output state word start address	16-bit, single word
S2	Specify the output state bit start address	Bit
S3	Specify axis group number	16-bit, single word

(3) Suitable soft component

Operand	Word soft component								Bit soft component								
	System								Constant	Module		System					
	D*	FD	TD*	CD*	DX	DY	DM*	DS*	K/H	ID	QD	X	Y	M*	S*	T*	C*
S0	●	●	●	●	●	●	●	●									
S1	●	●	●	●	●	●	●	●									
S2														●			
S3	●								●								

*: D means D, HD; TD means TD and HTD; CD means CD, HCD, HSCD and HSD; DM means DM and DHM; DS means DS and DHS; M means M, HM, SM; S means S, HS; T means T, HT; C means C, HC.

(4) Function and action



- S0 specifies the input parameter start address
- S1 specifies the output state word start address
- S2 specifies output state bit start address
- S3 specifies the axis group number
- When M0 is from off → on, the spiral motion control is performed for the axis group specified by S3. Its mode is determined by S0, the trajectory direction is jointly determined by S0 + 1 and S0 + 2, the spiral height is jointly determined by S0 + 40 and S0 + 44, the speed is S0 + 48, the acceleration and deceleration are S0 + 52, S0 + 56, and the jerk speed is S0 + 60

(5) Related parameters

Input parameter	Parameter name	Data type	Unit	Note
S0	Mode	INT16U	-	Arc mode 0: three points 1: circle center 2: radius
S0+1	Pathselected	INT16U	-	Path selection 0: Clockwise, radius mode inferior arc 1: Counterclockwise, radius mode, superior arc
S0+2	Planeselcted	INT16U	-	Plane selection 0: XOY plane 1: ZOX plane 2: YOZ plane

Input parameter	Parameter name	Data type	Unit	Note
S0+3	Velselected	INT16U	-	Speed mode 0: linear speed 1: arc speed 2: axis speed
S0+4	AuxX	FP64	Command unit	Auxiliary point X1
S0+8	AuxY	FP64	Command unit	Auxiliary point Y1
S0+12	AuxZ	FP64	Command unit	Auxiliary point Z1
S0+16	PosX	FP64	Command unit	Target point X2
S0+20	PosY	FP64	Command unit	Target point Y2
S0+24	PosZ	FP64	Command unit	Target point Z2
S0+28	PosA	FP64	Command unit	Target point A
S0+32	PosB	FP64	Command unit	Target point B
S0+36	PosC	FP64	Command unit	Target point C
S0+40	Pitch	FP64	Command unit	Pitch P
S0+44	Count	FP64	-	Turns N
S0+48	Vel	FP64	Command unit /s	Speed
S0+52	Acc	FP64	Command unit /s ²	Acceleration
S0+56	Dec	FP64	Command unit /s ²	Deceleration
S0+60	Jerk	FP64	Command unit /s ³	Jerk speed
S0+64	CoordinatSystem	INT16U	-	Coordinate system. Not supported at the moment
S0+65	Buffer	INT16U	-	Buffer mode 0: interrupt 1: buffer
S0+66	TransitionMode	INT16U	-	Transition method. Not supported at the moment
S0+68	EndVel	FP64	Command unit /s	End speed. Not supported at the moment
S0+72	TransitionVel	FP64	Command unit /s	Transition speed
Output parameter	Parameter name	Data type	Unit	Note
S1	ErrCode	INT16U	-	Command error code
State parameter	Parameter name	Data type	Unit	Note
S2	Done	BOOL	-	Instruction execution completed
S2+1	Busy	BOOL	-	The instruction is being executed
S2+2	Active	BOOL	-	Command under control
S2+3	Abort	BOOL	-	Instruction is interrupted
S2+4	Error	BOOL	-	Instruction execution error
Axis number	Parameter name	Data type	Unit	Note

Input parameter	Parameter name	Data type	Unit	Note
S3	Axis	INT16U	-	Axis number starts from 0

Note: the relationship between deceleration and jerk speed is same to command A_MOVEA, refer to chapter 5-1-2-7 item (5) for details.

- Parameter [plane selection] determines the plane of the arc, and the other direction is radial.
- The parameter [pitch] is the lead of one revolution.
- When the parameter [number of turns] is 0, the arc moves synchronously with the axial direction, and the end point is the target point. When it is greater than 0, the system calculates the end point according to the number of turns, pitch and starting point.
- Arc mode 0 3-points:
 The spiral trajectory is determined by the current position (X, Y, Z), auxiliary point (X1, Y1, Z1) and target point (X2, Y2, Z2). In this mode, the [path selection] parameter is not effective, and the radial position in the auxiliary point is invalid.
 Taking the XOY plane as an example, the unique arc is determined on the plane according to the current position (X, Y), auxiliary point (X1, Y1) and target point (X2, Y2) (at this time, the z-axis coordinate is invalid), and the arc track of XOY plane is determined. After the plane trajectory is defined, the radial motion direction is determined according to the radial coordinates, that is, the current coordinate Z of the Z axis and the target point coordinate Z2 (the current position is in the direction of the target position). Finally, the start point and end point distance of a single rotation in the Z-axis direction is determined by the pitch P, and the movement stops after repeating the number of turns N times. The pitch and the number of turns jointly determine the Z-axis coordinate of the stop position. Please refer to examples for detailed effects.
- Arc mode 1 circle center:
 The spiral track is determined by plane selection, path selection and axial direction. In this mode, the radial position of auxiliary point is invalid.
 Taking the XOY plane as an example, two arcs can be determined on the plane according to the current position coordinates (X, Y), the center coordinates of auxiliary points (X1, Y1) and the end coordinates (X2, Y2) (at this time, the Z-axis coordinates are invalid), and then the arc trajectory of the final XOY plane is determined by the path selection parameters. After the plane trajectory is defined, the radial motion direction is determined by the radial coordinates, that is, the current coordinate Z of the Z axis and the target point coordinate Z2 (the current position is in the direction of the target position). Finally, the start point and end point distance of a single rotation in the Z-axis direction is determined by the pitch P, and the movement stops after repeating the number of turns N times. The pitch and the number of turns jointly determine the Z-axis coordinate of the stop position. Please refer to examples for detailed effects.
 The judgment rules of clockwise and counterclockwise are: make a fist with your right hand.
 The thumb is in the radial direction, the four fingers are counter-clockwise and the reverse direction is clockwise.
- Arc mode 2 radius:
 The spiral track is determined by user input parameters, plane selection and path selection. In this mode, the auxiliary point is only valid for the radial vector value.
 Taking the XOY plane as an example, the Z axis coordinate absolute value (0,0, Z) is set as radius |Z| by the auxiliary point. On the plane, two semicircles or four arcs (two superior arcs and two inferior arcs) can be determined by the current position coordinates (X, Y), radius and end point coordinates (X2, Y2) (at this time, the Z axis coordinates are invalid), and then the superior and inferior arcs can be selected by the path selection parameters. The positive and negative values of the Z-axis of the auxiliary point determine the trajectory rotation direction (positive counter-clockwise/negative clockwise), which determines the final XOY plane arc trajectory. After the plane trajectory is defined, the radial motion direction is determined by the radial coordinates, that is, the current coordinate Z of the Z axis and the target point coordinate Z2 (the current position is in the direction of the target position). Finally, the start point and end point distance of a single rotation in the Z-axis direction is determined by the pitch P, and the movement stops after repeating the number of turns N times. The pitch and the number of turns jointly determine the Z-axis coordinate of the stop position. Please refer to examples for detailed effects.
 The judgment rules of clockwise and counterclockwise are: make a fist with your right hand.
 The thumb is in the radial direction, the four fingers are counter-clockwise and the reverse direction is clockwise.

(6) Sequence diagram

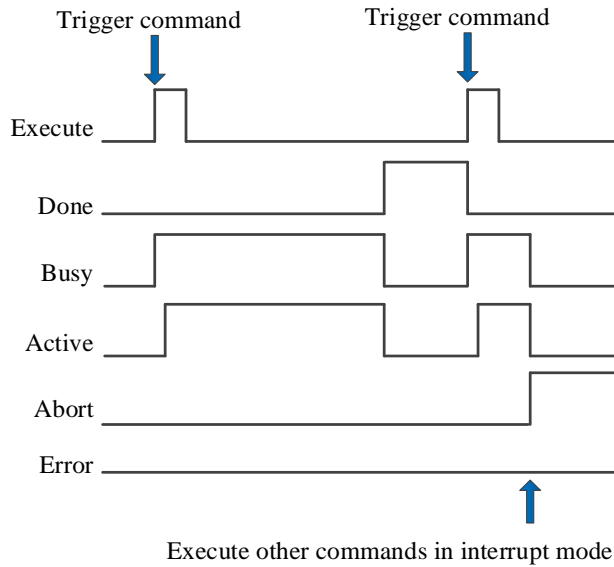

Explanation:

Generally, after the command is triggered, the Busy and Active signals are set, and reset after the command is executed. At the same time, the Done signal is set. Done will reset only after the command is triggered again, otherwise it will not reset automatically.

When the instruction is triggered in the buffer mode and there are currently instructions being executed, the Active signal will be set immediately. The execution of the current instruction ends. When the instruction is executed, the Busy signal will be set. After the execution of the instruction ends, the Busy and Active signals will be reset and the Done signal will be set.

When a new instruction is triggered in interrupt mode during instruction execution, the Busy and Active signals are reset immediately and the Abort signal is set.

When there is an error in the command, the Error signal is set, other signals are reset, and the corresponding error code is output.

(7) Application

- Arc mode 0 3-points:
Start point (0,0,0), target point (131072,131072,131072), auxiliary point (60000, 80000, Z1), pitch 100000, turns number 3, perform spiral at the linear speed 100000. The ladder diagram is shown as below:

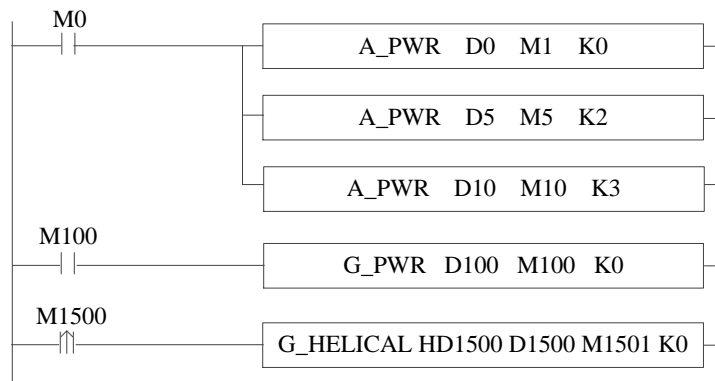

The command parameters:

G_HELICALInstruction parameter configuration

Input parameter: Output parameter: Status parameter:

Effective shaft group no:

Name	Addr	Online value	Offline value	Data type	statement
Input parameter					
Mode	HD1500	Threepoints	Threepoints	INT16U	The circular arc model
PathSelected	HD1501	Clockwise	Clockwise	INT16U	Path selection
PlaneSelected	HD1502	XOY	XOY	INT16U	Plane selection
VelMode	HD1503	Linearvelocity	Linearvelocity	INT16U	Speed Mode
AuxX	HD1504	0	60000	FP64	Auxiliary position X
AuxY	HD1508	0	80000	FP64	Auxiliary position Y
AuxZ	HD1512	0	0	FP64	Auxiliary position Z
PosX	HD1516	0	131072	FP64	Position X
PosY	HD1520	0	131072	FP64	position Y
PosZ	HD1524	0	131072	FP64	position Z
PosA	HD1528	0	0	FP64	position A
PosB	HD1532	0	0	FP64	position B
PosC	HD1536	0	0	FP64	position C
Pitch	HD1540	0	100000	FP64	pitch
Count	HD1544	0	3	FP64	Number of turns
Vel	HD1548	0	100000	FP64	speed
Acc	HD1552	0	0	FP64	The acceleration
Dec	HD1556	0	0	FP64	Reduce speed

space usage : ID1500-HD1575,D1500-D1500,M1501-M1505.

The grabbing track of oscilloscope is as follows:

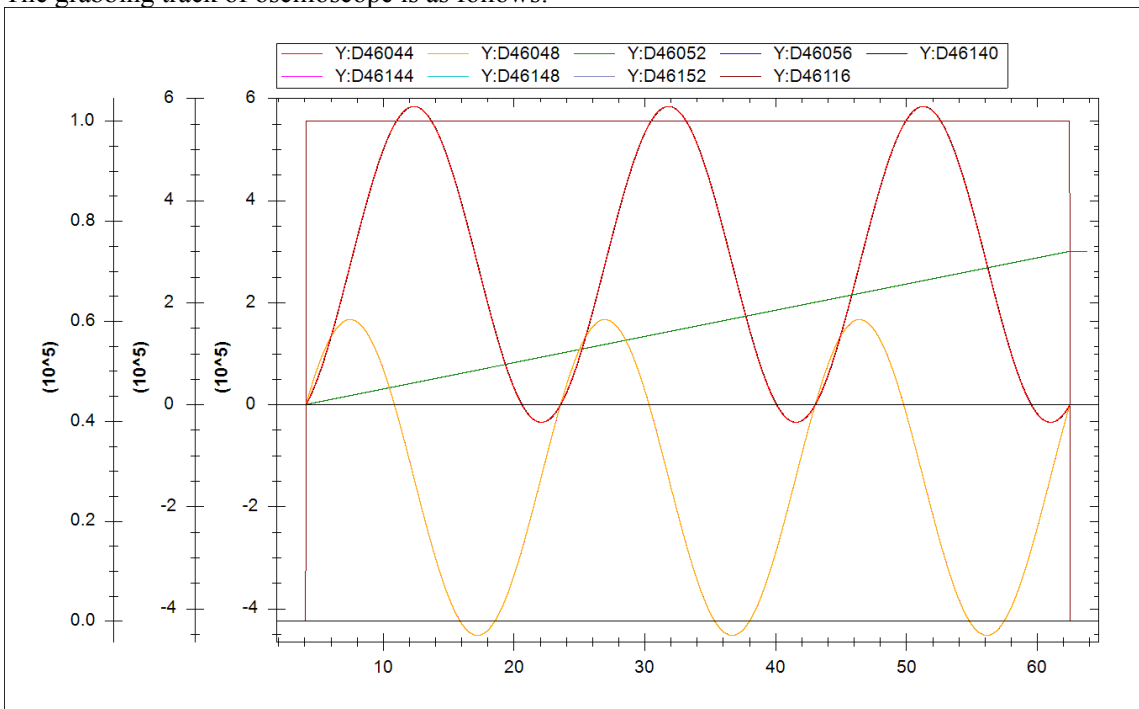

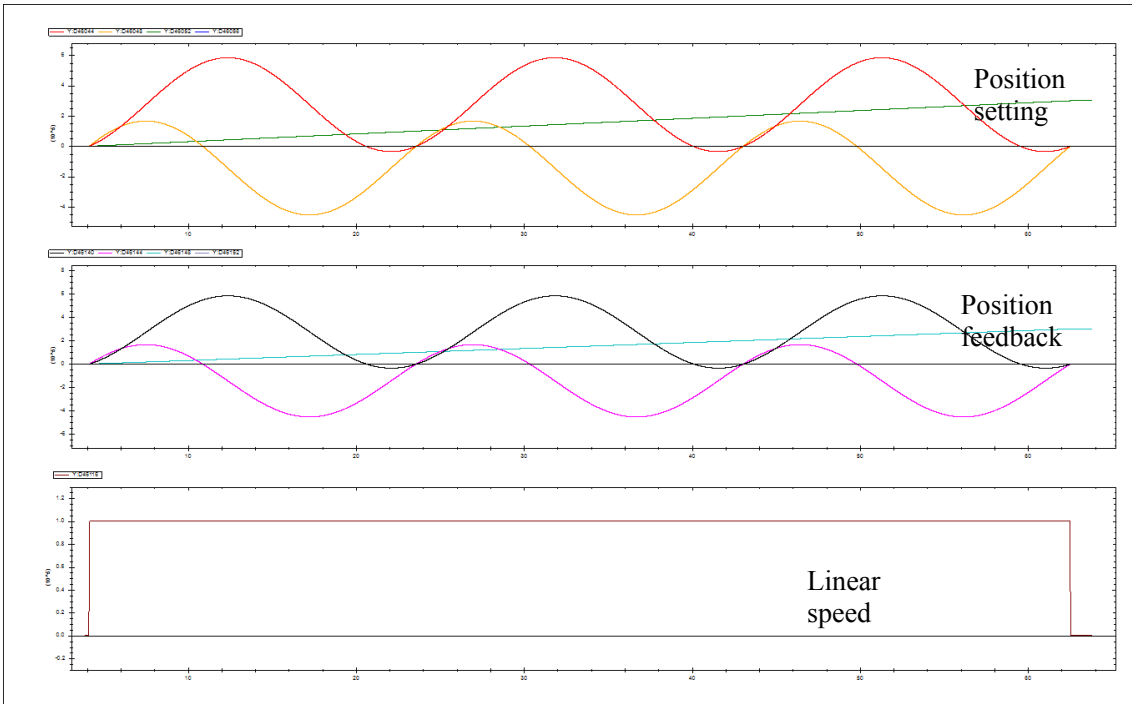

LABVIEW synthetic trajectory is as follows:

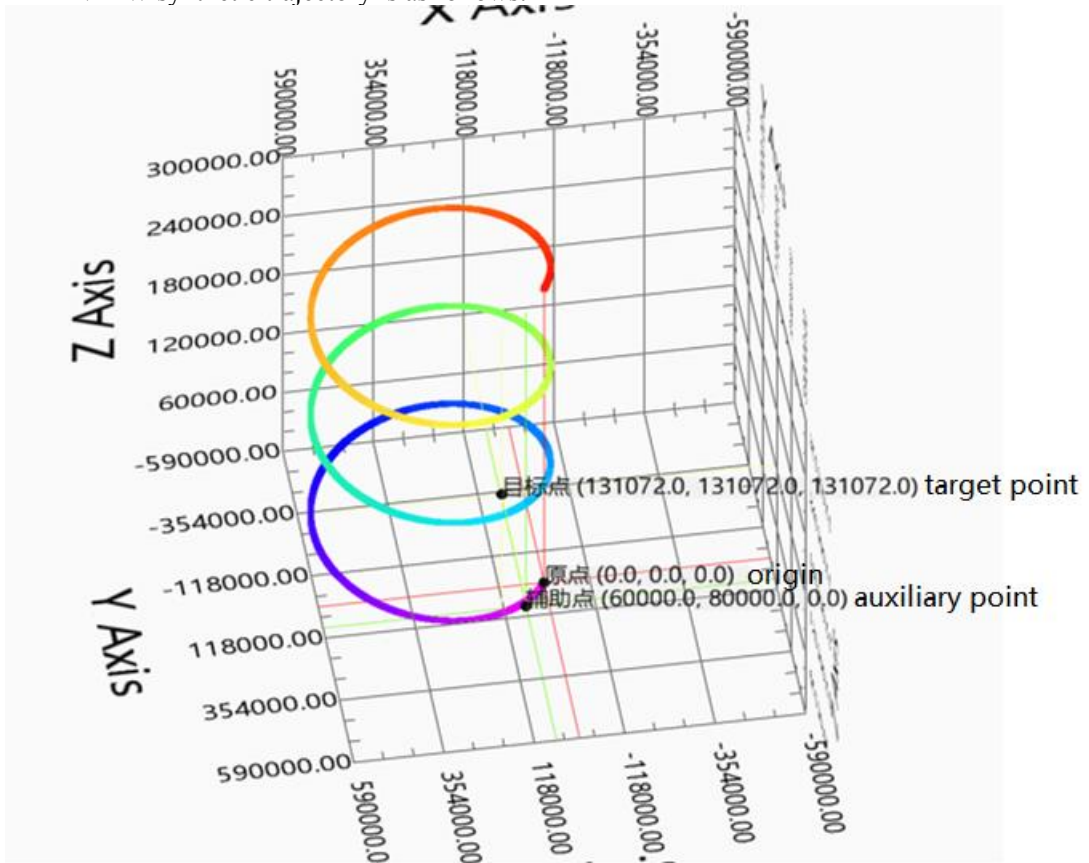

The exploded views of each plan are as follows:

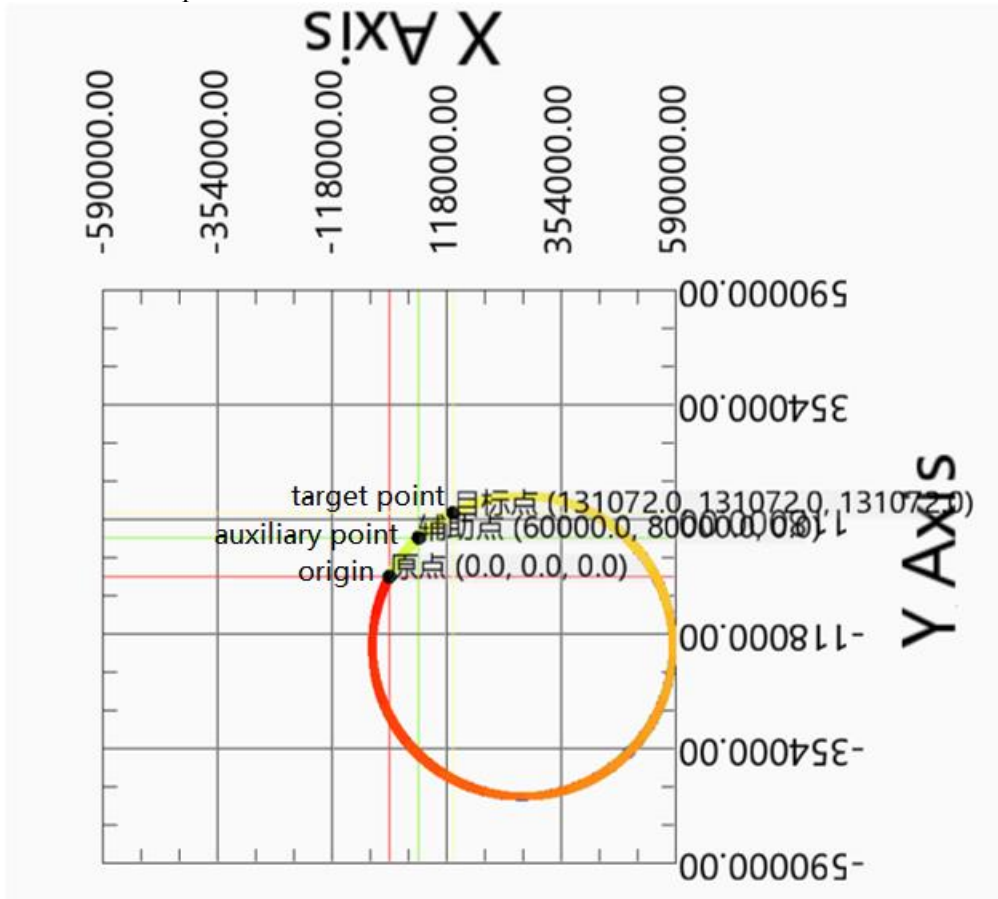

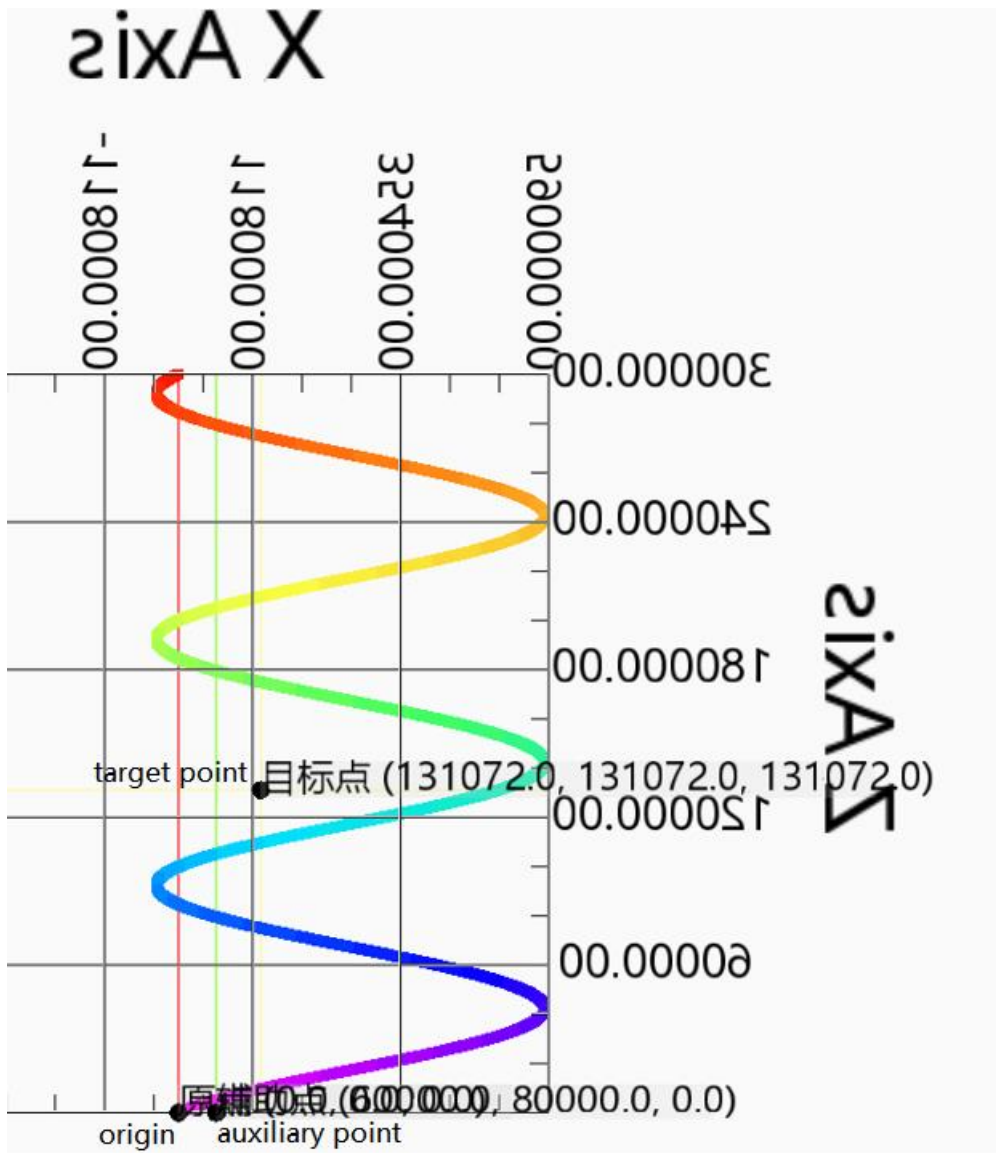

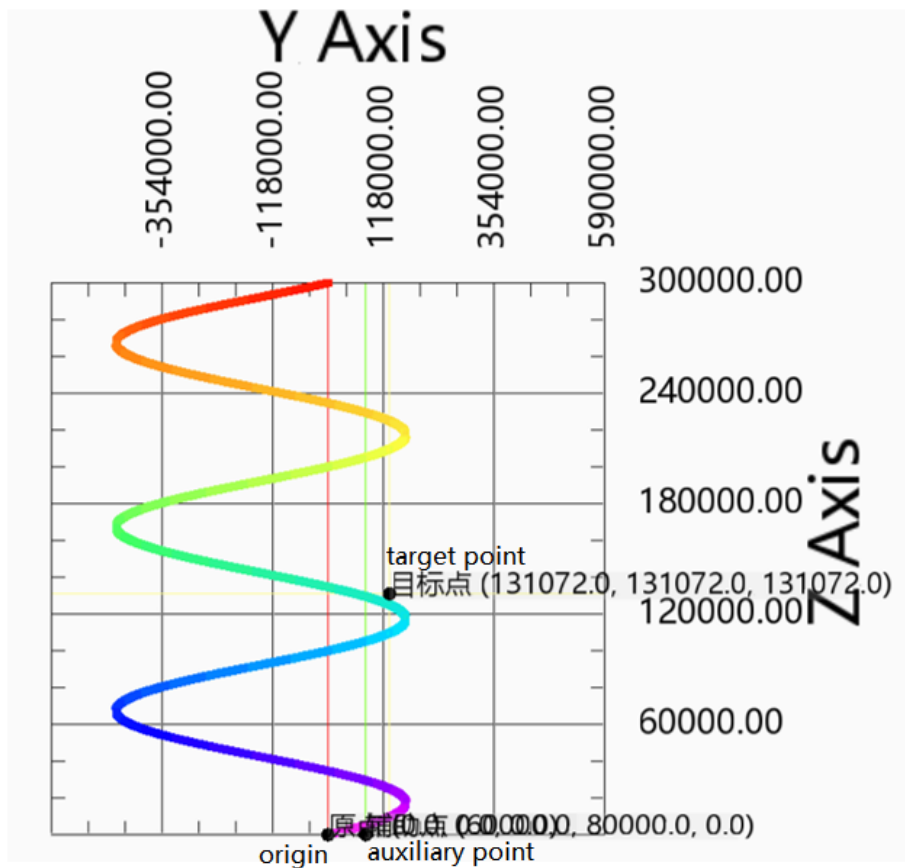

Action decomposition: the two axes of the XOY plane perform the plane circle action. The circle track is determined by the coordinates of the starting point, auxiliary point and target point on the selected plane. The circle motion is repeated for 3 times. The Z-axis moves in a straight line at a uniform speed, and the moving distance is the number of turns \times Pitch. The three axes start and stop at the same time, and the three-axis speed is decomposed into XOY plane linear speed and Z-axis linear speed.

Note: if the number of turns is greater than 0, the actual motion trajectory of the curve does not necessarily pass through the auxiliary point and target point.

Other parameters remain unchanged, and the running track is as follows when the number of turns is 0:

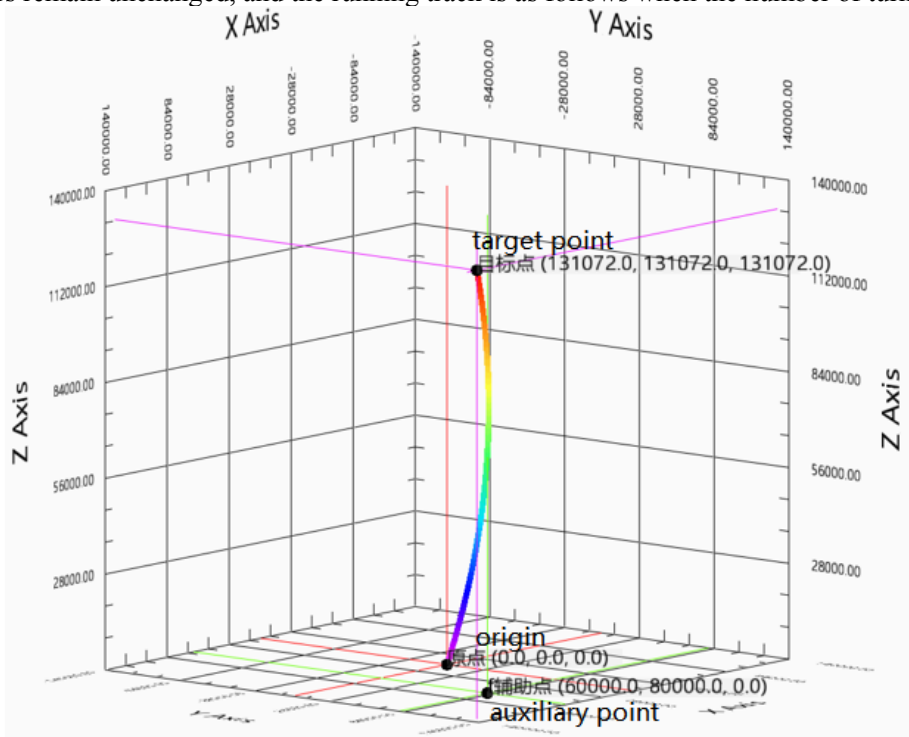

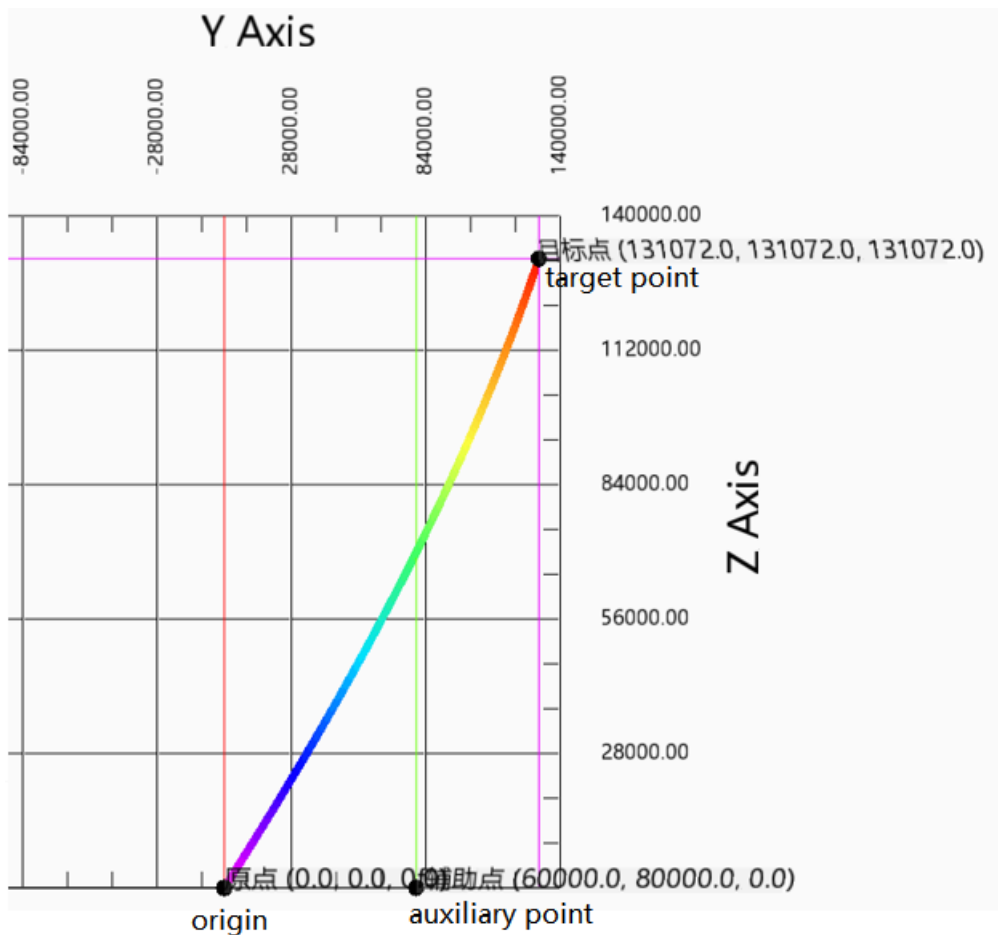

Action decomposition: the two axes of XOY plane perform plane arc action, and the arc track is determined by the coordinates of the starting point, auxiliary point and target point on the selected plane. The Z-axis moves in a straight line at a uniform speed, and the moving distance is the difference between the starting point of the Z-axis and the target point. The three axes start and stop at the same time, and the three-axis speed is decomposed into XOY plane linear speed and Z-axis linear speed.

- Arc mode 1 circle center:
Start point (0,0,0), target point (131072,0,131072), circle center (65536,10000, Z1), pitch 100000, turn numbers 3, execute the spiral at 100000 linear speed, and the spiral line rotates clockwise.

The command parameters are shown as below:

G_HELICALInstruction parameter configuration

Input parameter: Output parameter: Status parameter:

Effective shaft group no:

Name	Addr	Online value	Offline value	Data type	statement
Input parameter					
Mode	HD1500	Threepoints	Threepoints	INT16U	The circular arc model
PathSelected	HD1501	Clockwise	Clockwise	INT16U	Path selection
PlaneSelected	HD1502	XOY	XOY	INT16U	Plane selection
VelMode	HD1503	Linearvelocity	Linearvelocity	INT16U	Speed Mode
AuxX	HD1504	0	65535	FP64	Auxiliary position X
AuxY	HD1508	0	10000	FP64	Auxiliary position Y
AuxZ	HD1512	0	0	FP64	Auxiliary position Z
PosX	HD1516	0	131072	FP64	Position X
PosY	HD1520	0	0	FP64	position Y
PosZ	HD1524	0	131072	FP64	position Z
PosA	HD1528	0	0	FP64	position A
PosB	HD1532	0	0	FP64	position B
PosC	HD1536	0	0	FP64	position C
Pitch	HD1540	0	100000	FP64	pitch
Count	HD1544	0	3	FP64	Number of turns
Vel	HD1548	0	100000	FP64	speed
Acc	HD1552	0	0	FP64	The acceleration
Dec	HD1556	0	0	FP64	Reduce speed

space usage : ID1500-HD1575,D1500-D1500,M1501-M1505.

The grabbing track of oscilloscope is as follows:

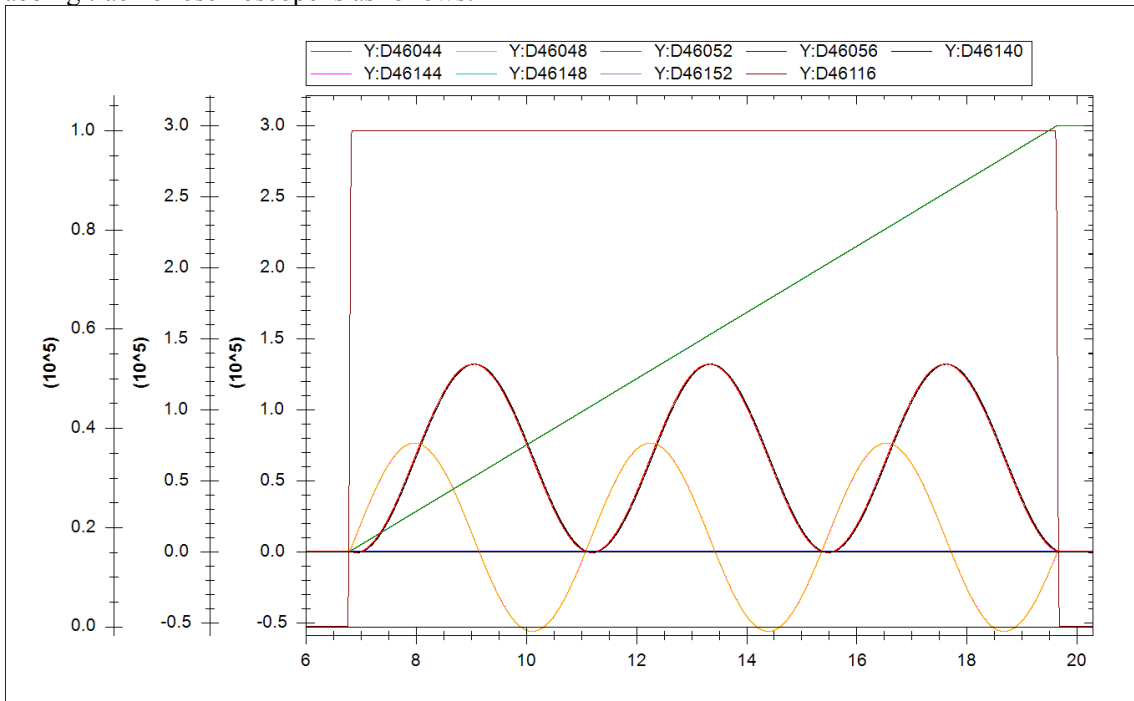

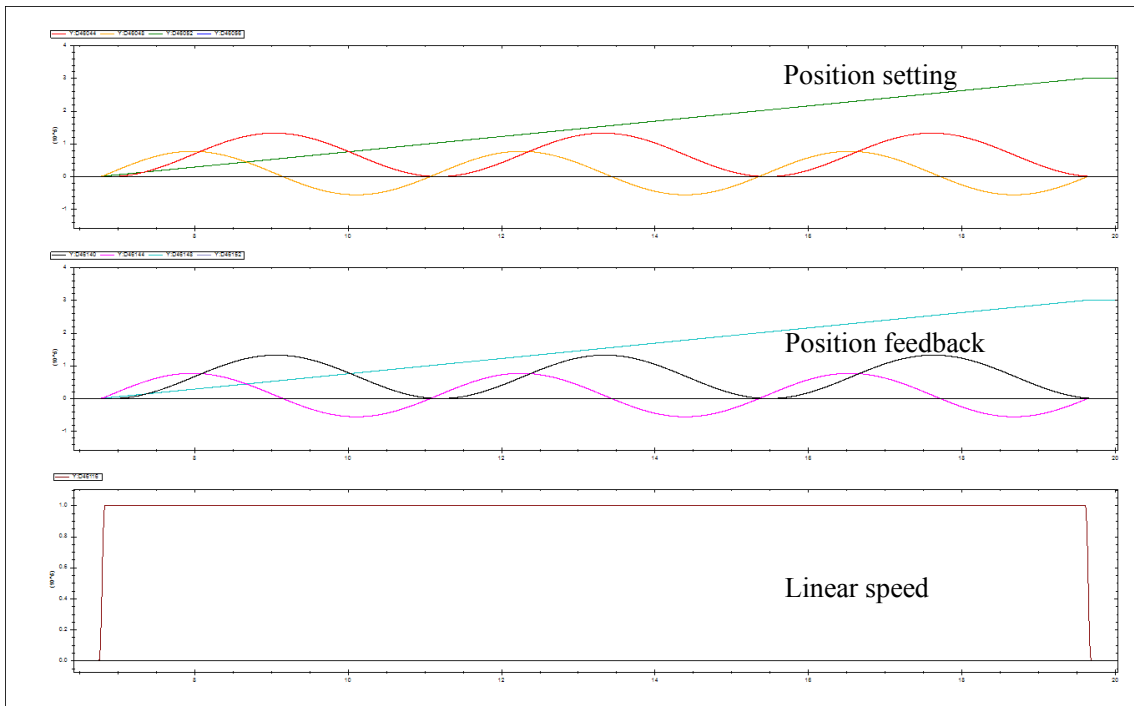

The synthesis trajectory of LabVIEW is as follows:

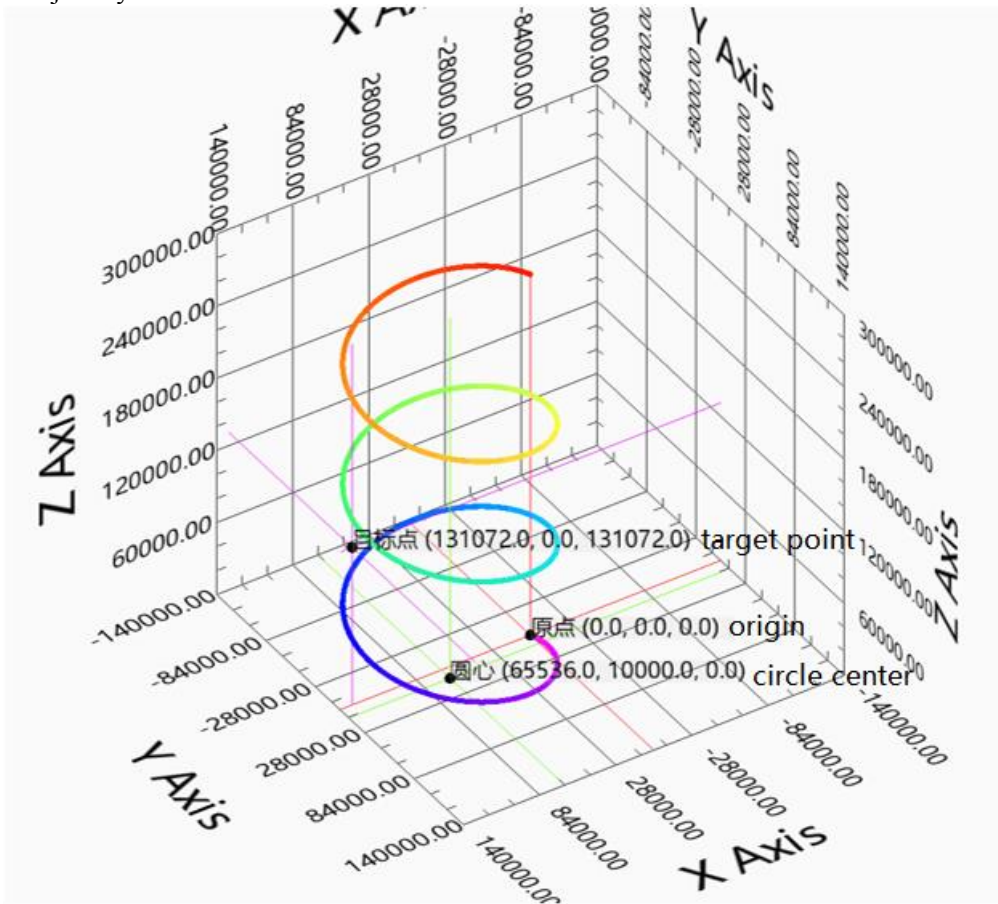

The breakdown drawing of each plane:

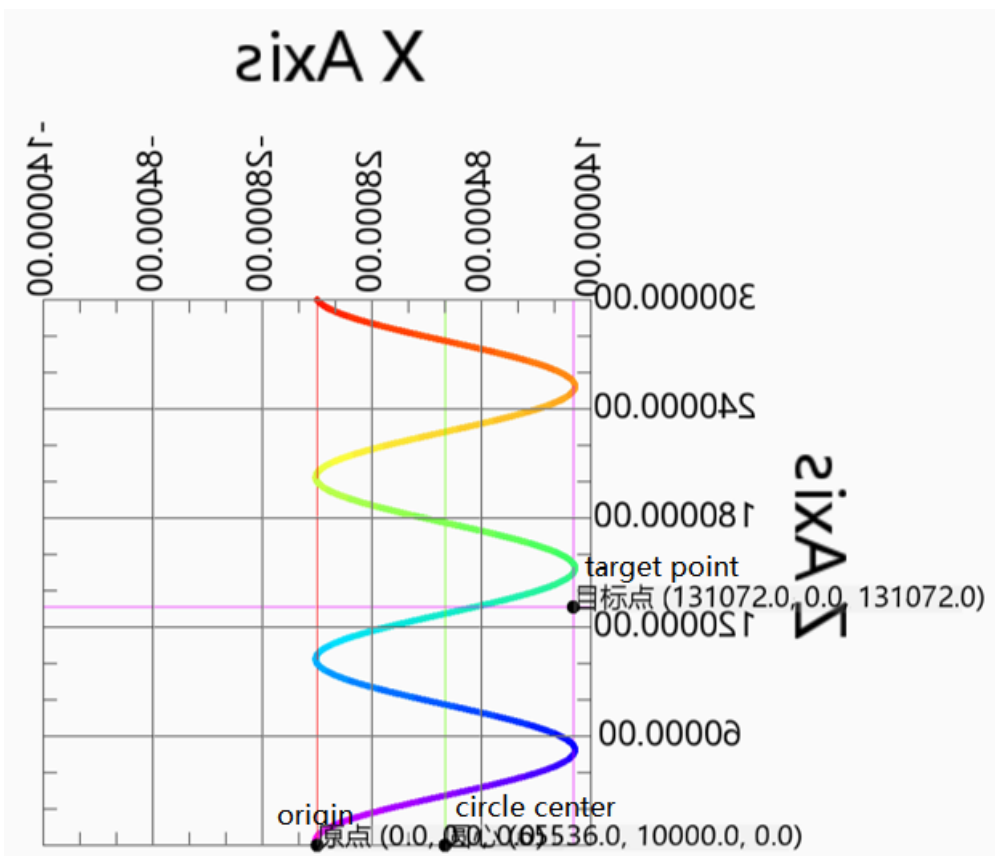
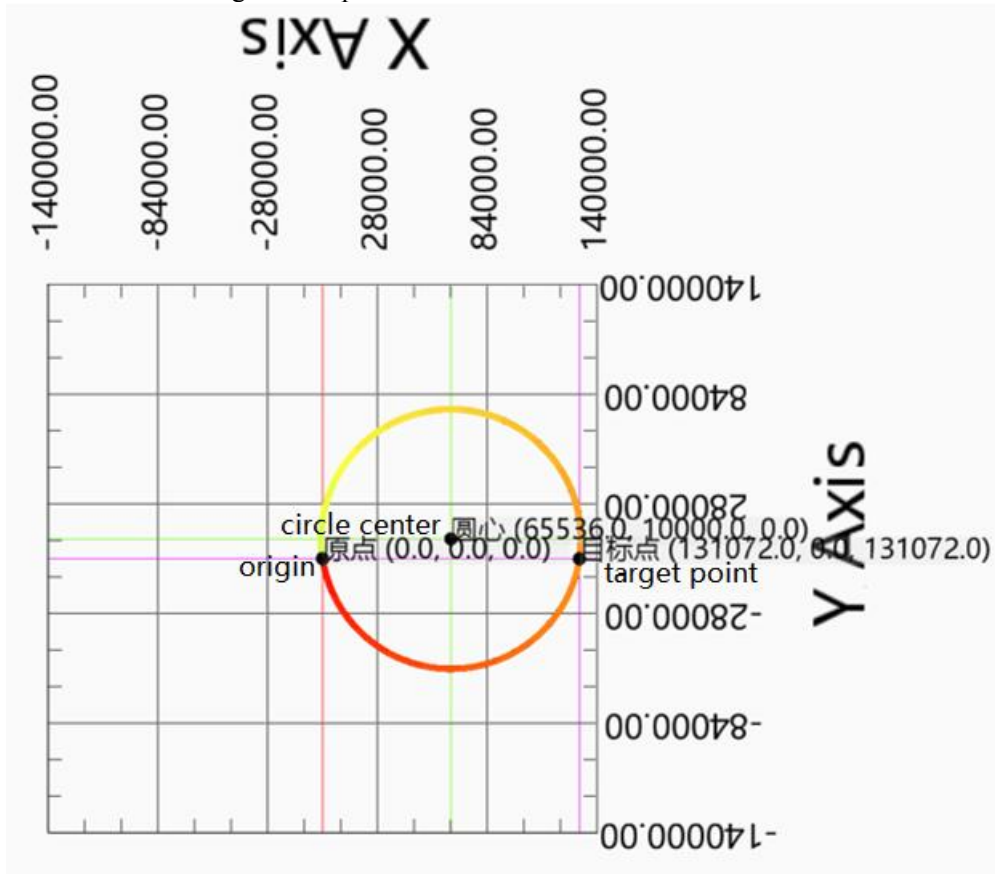

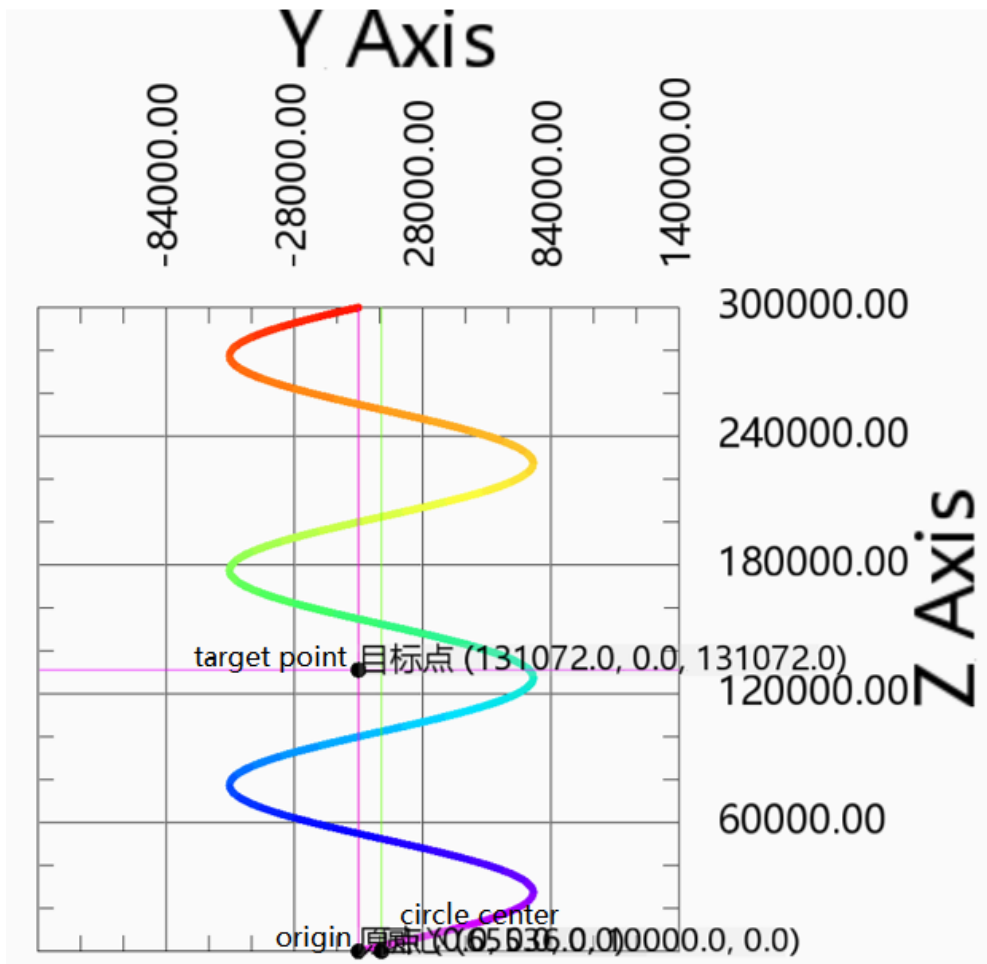

Action decomposition: the two axes of the XOY plane do the plane circle action. The circle track is determined by the starting point, center, target coordinates and path selection on the selected plane. The circle motion is repeated for 3 times. The Z-axis moves in a straight line at a uniform speed, and the moving distance is the number of turns \times Pitch. The three axes start and stop at the same time, and the three-axis speed is decomposed into XOY plane linear speed and Z-axis linear speed.

Note: If the number of turns is greater than 0, the actual motion trajectory of the curve does not necessarily pass through the target point.

Other parameters remain unchanged. When the number of turns is 0, the running track is as follows:

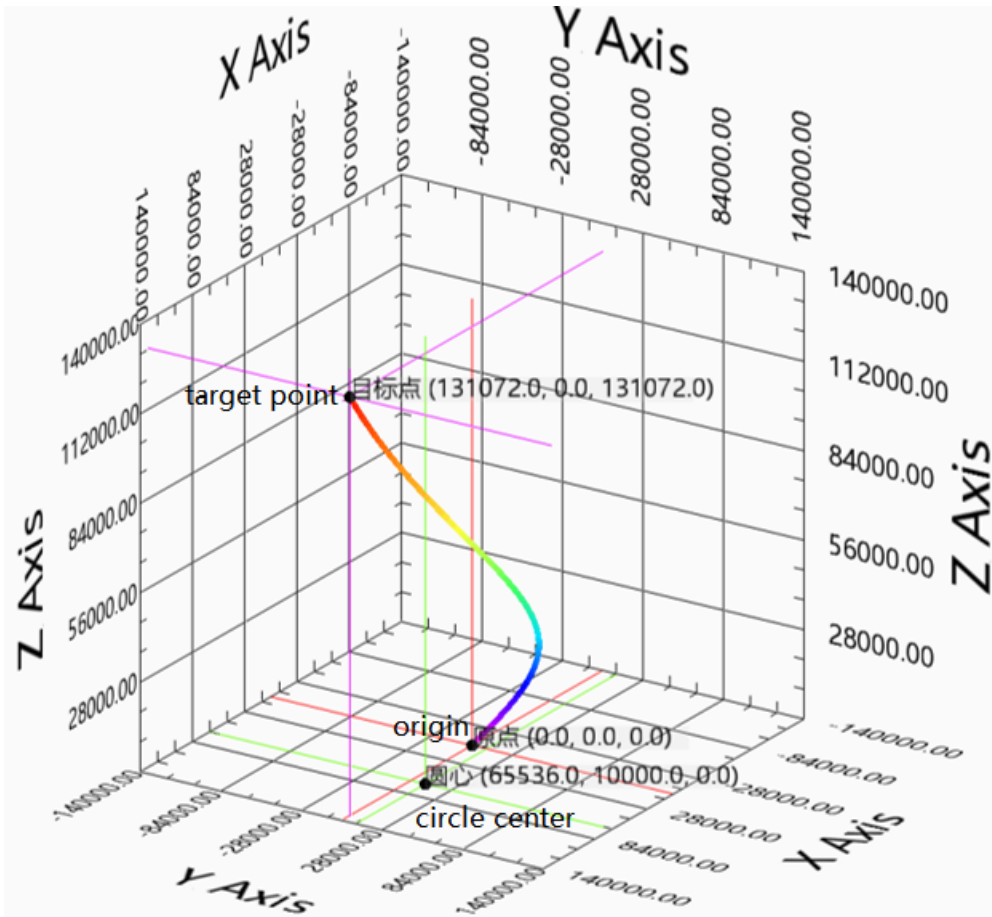

The breakdown drawing of each plane:

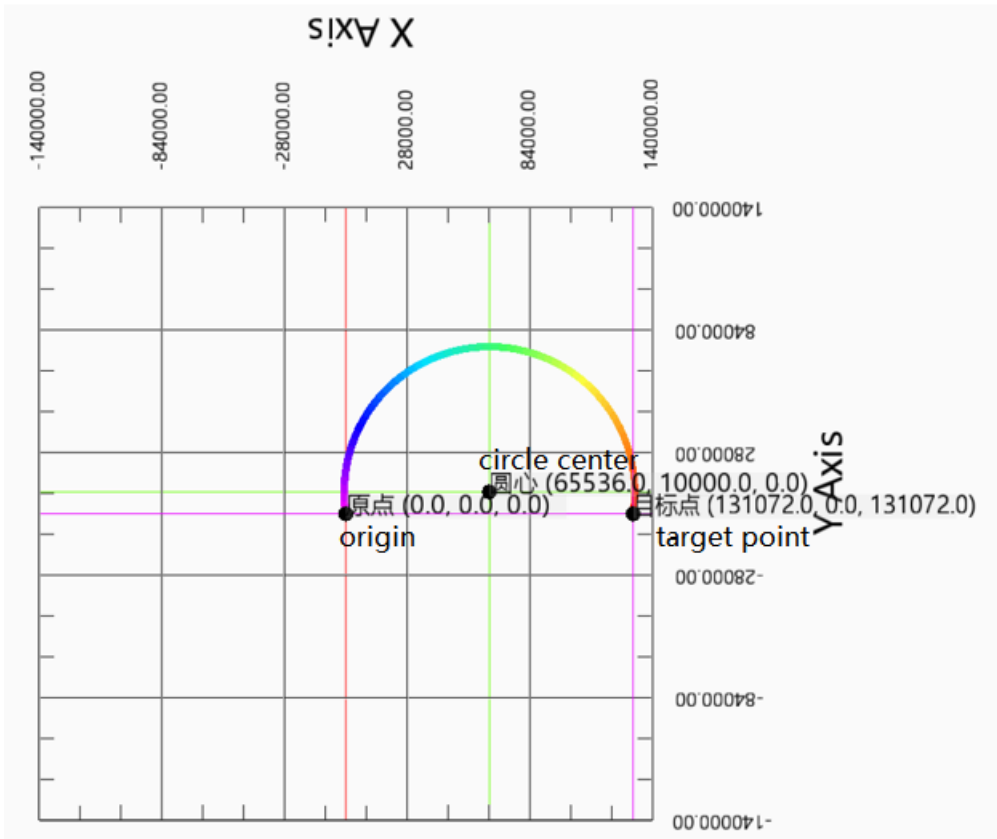

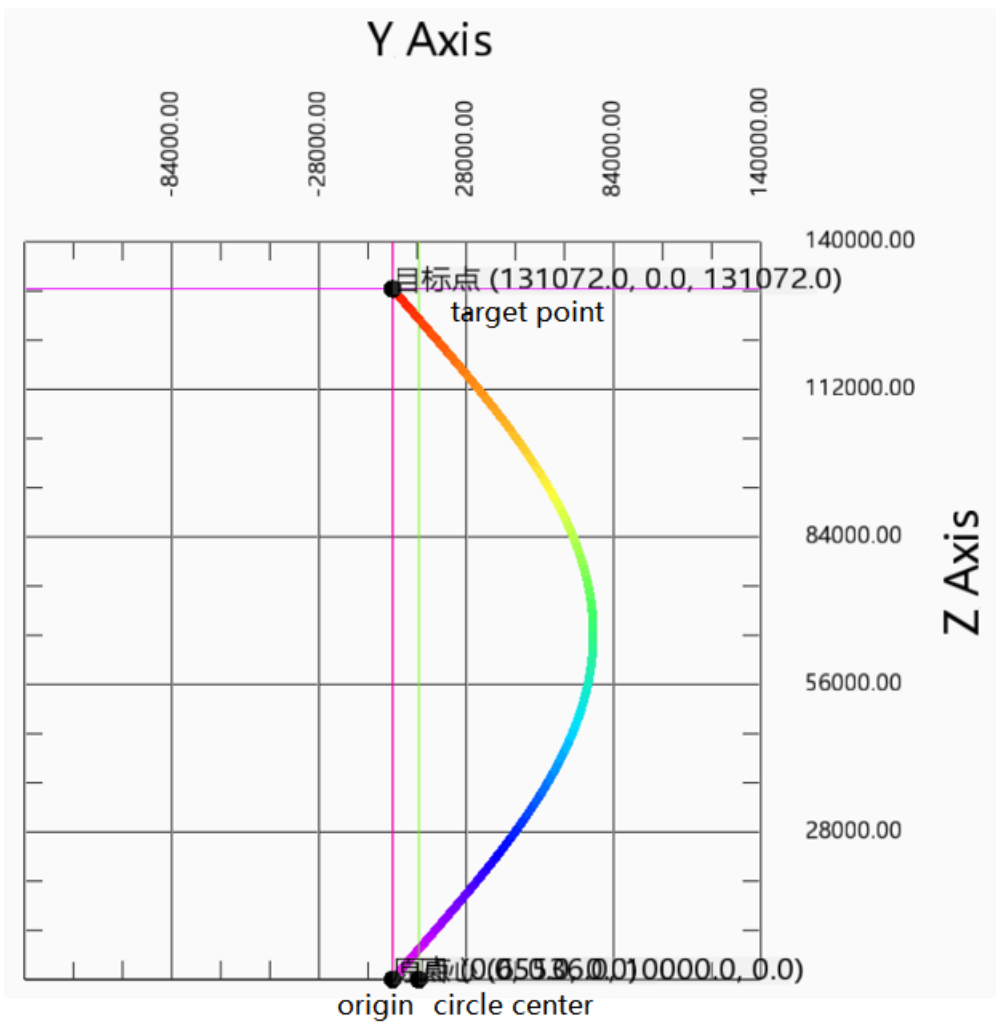
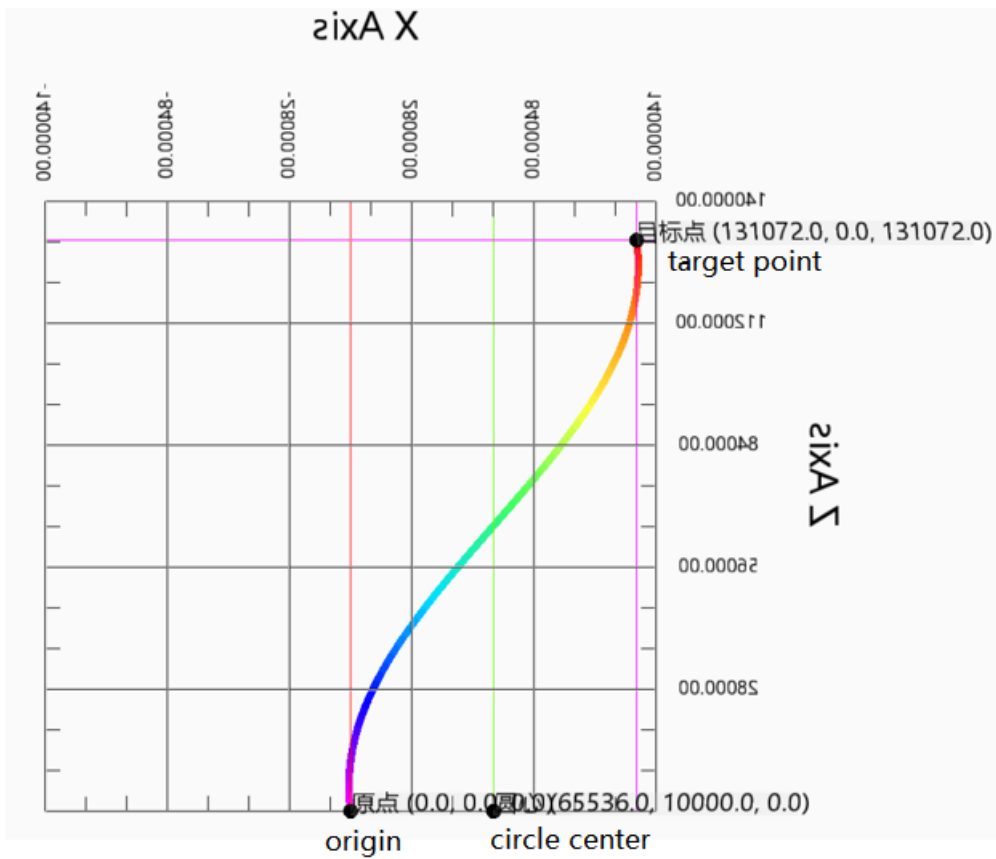

Action decomposition: the two axes of XOY plane do plane arc action, and the arc track is determined by the starting point, center, target coordinates and path selection on the selected plane. The Z-axis moves in a straight line at a uniform speed, and the moving distance is the difference between the starting point of the Z-axis and the target point. The three axes start and stop at the same time, and the three-axis speed is decomposed into XOY plane linear speed and Z-axis linear speed.

Note: when the number of turns is 0 and the starting and ending points are consistent, the track is a plane circle.

- Arc mode 2 radius:

Start point (0,0,0), target point (131072,131072,131072), radius 131072, pitch 100000, turns number 3, execute the helix at 100000 linear speed, and the helix rotates counterclockwise and moves towards the target point through the inferior arc.

The command parameters are shown as below:

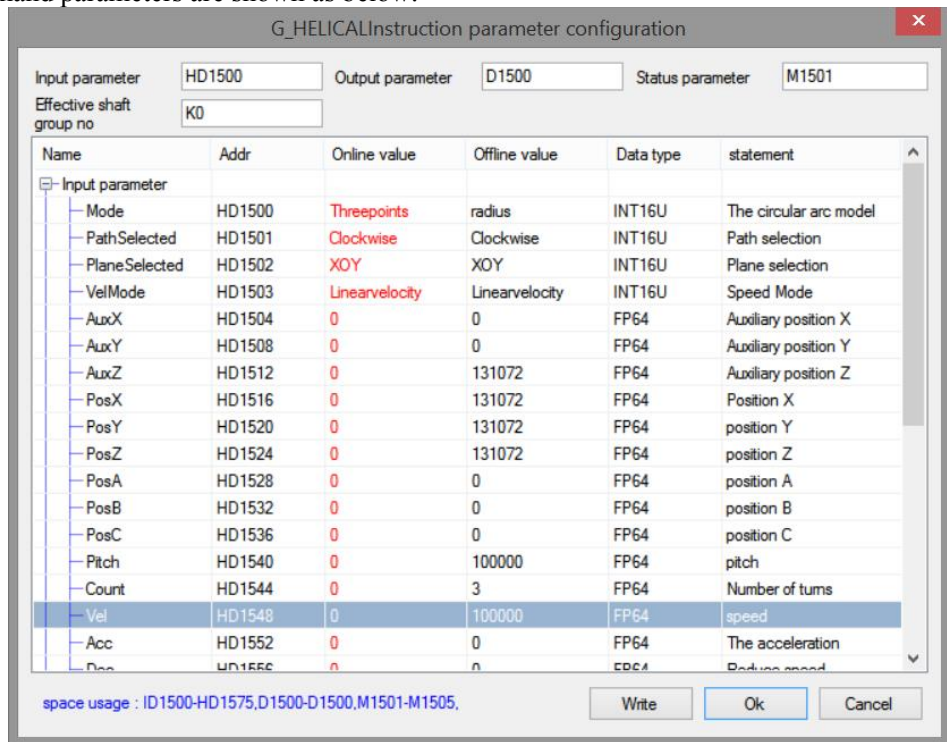

The grabbing track of oscilloscope is as follows:

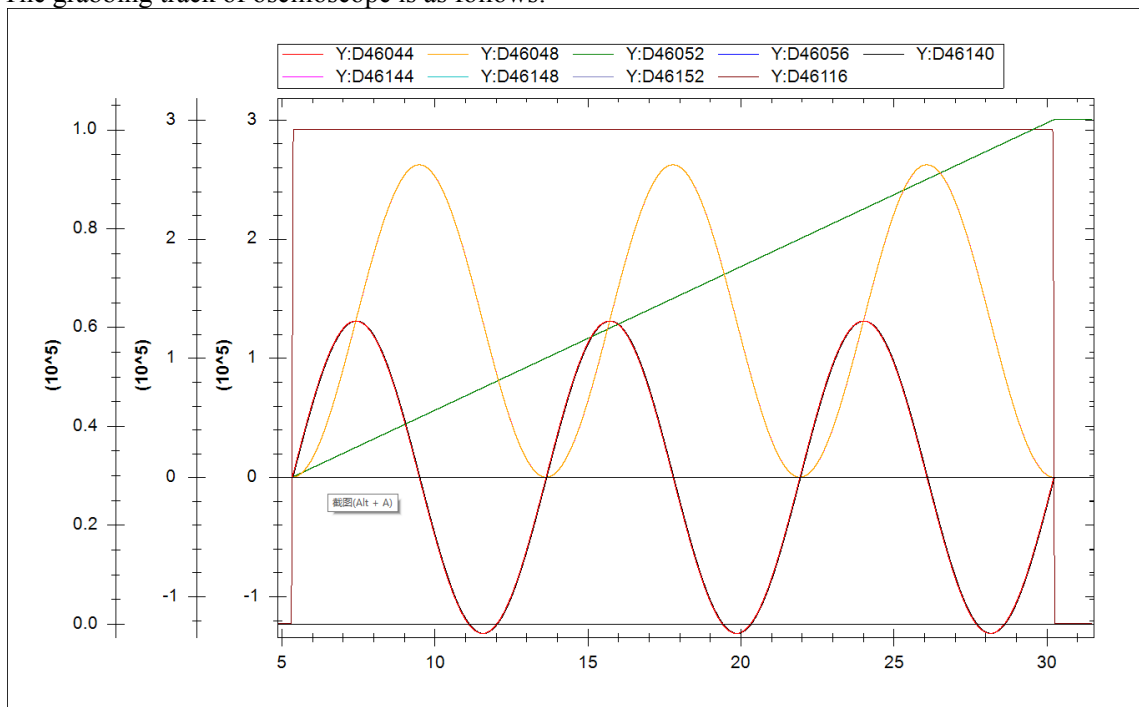

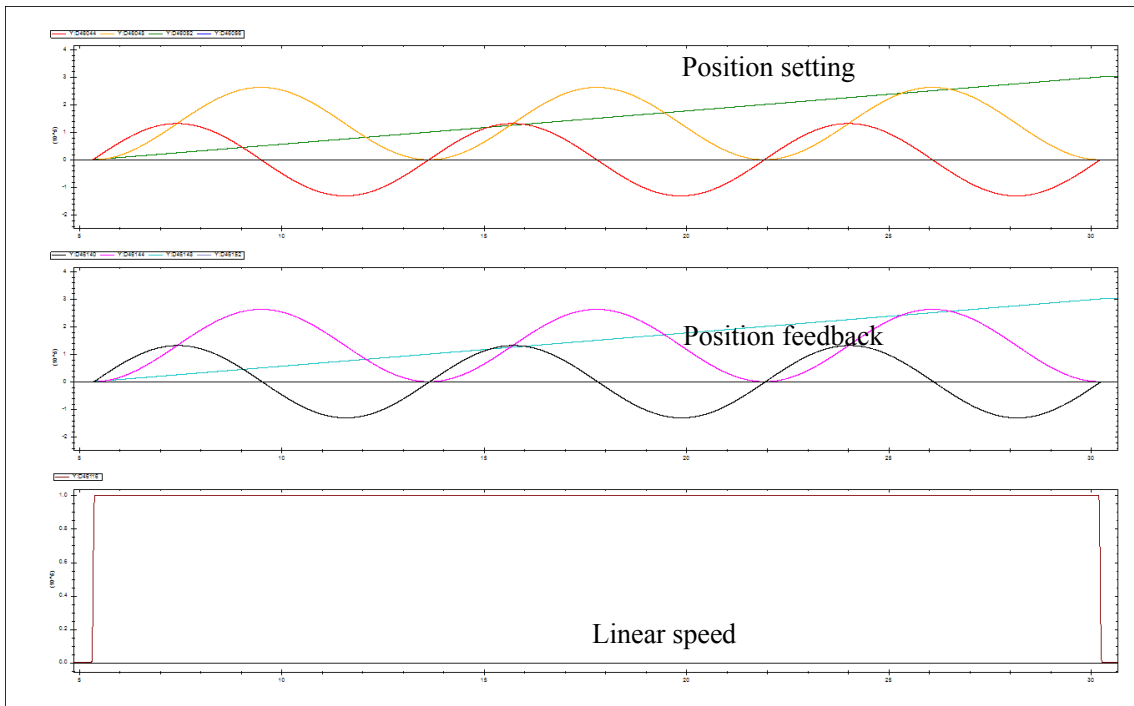

The synthesis trajectory of LabVIEW is as follows:

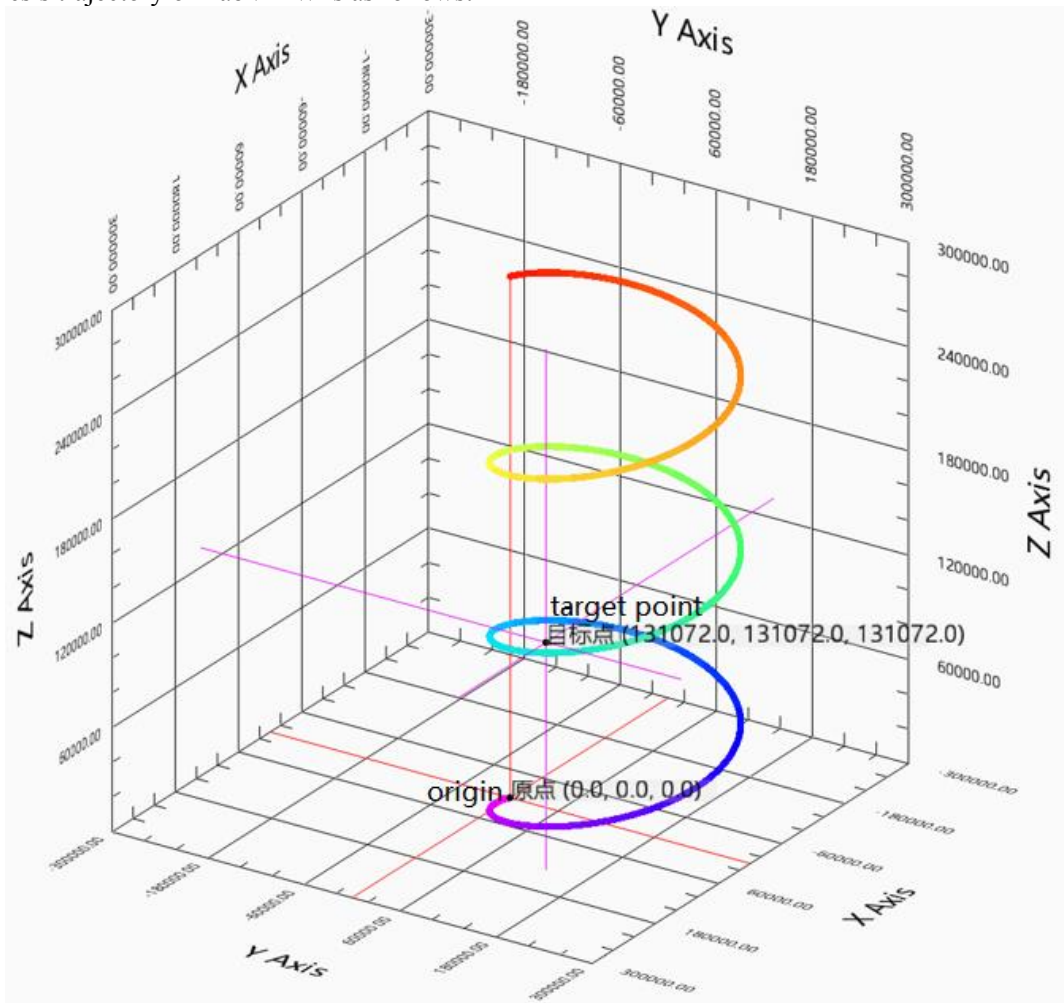

Exploded views of each plan are as follows:

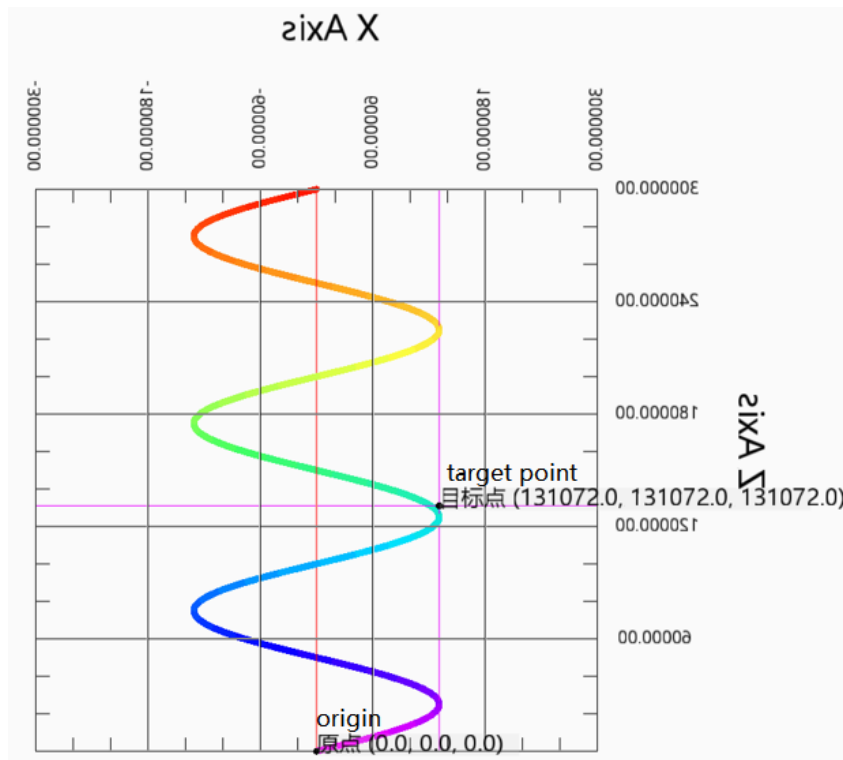
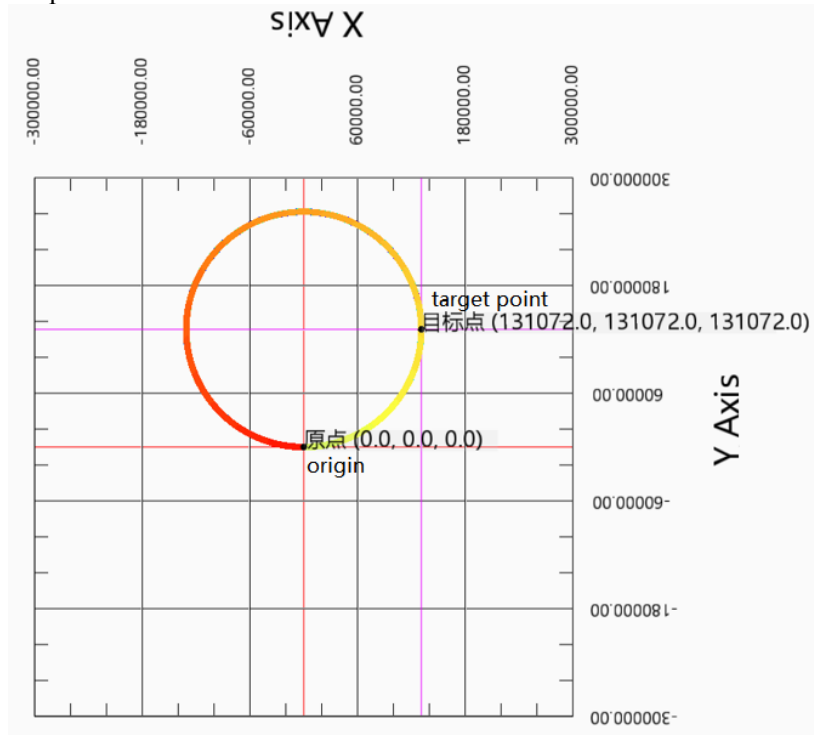

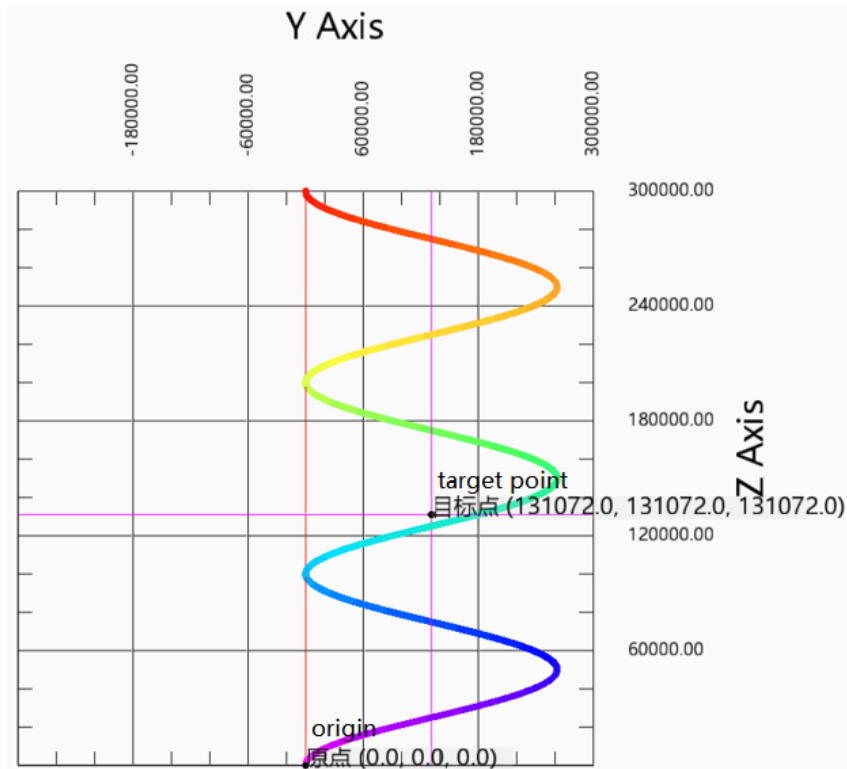

Action decomposition: the two axes of the XOY plane do the plane circle action. The circle track consists of the starting point, radius, target coordinates, rotation direction (positive and negative of Z axis) and arc type on the selected plane. The circle motion is repeated for 3 times. The Z-axis moves in a straight line at a uniform speed, and the moving distance is the number of turns \times Pitch. The three axes start and stop at the same time, and the three-axis speed is decomposed into XOY plane linear speed and Z-axis linear speed.
 Note: if the number of turns is greater than 0, the actual motion trajectory of the curve does not necessarily pass through the target point.

Other parameters remain unchanged. When the number of turns is 0, the running track is as follows:

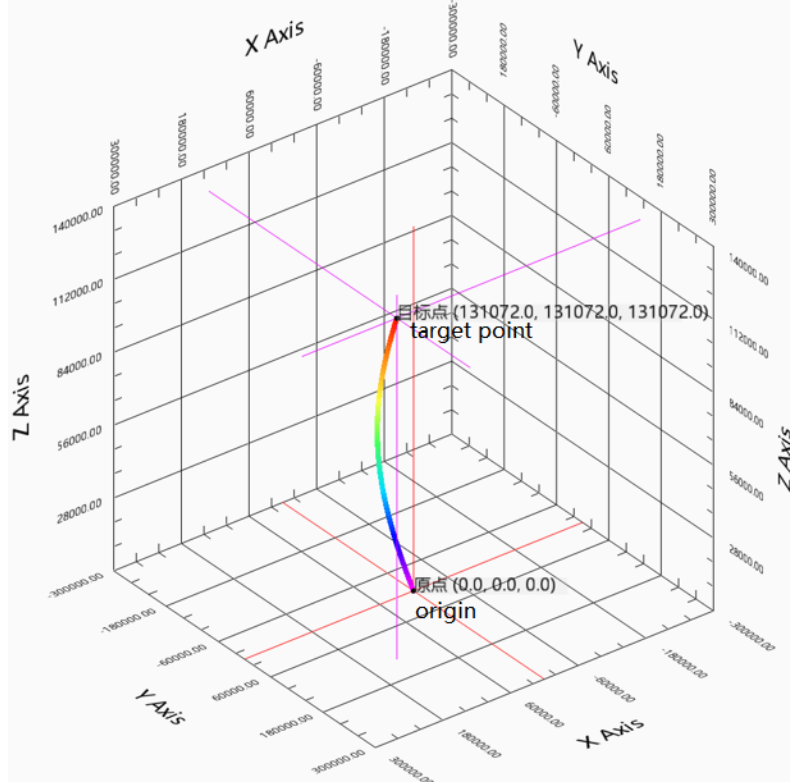

Exploded views of each plan are as follows:

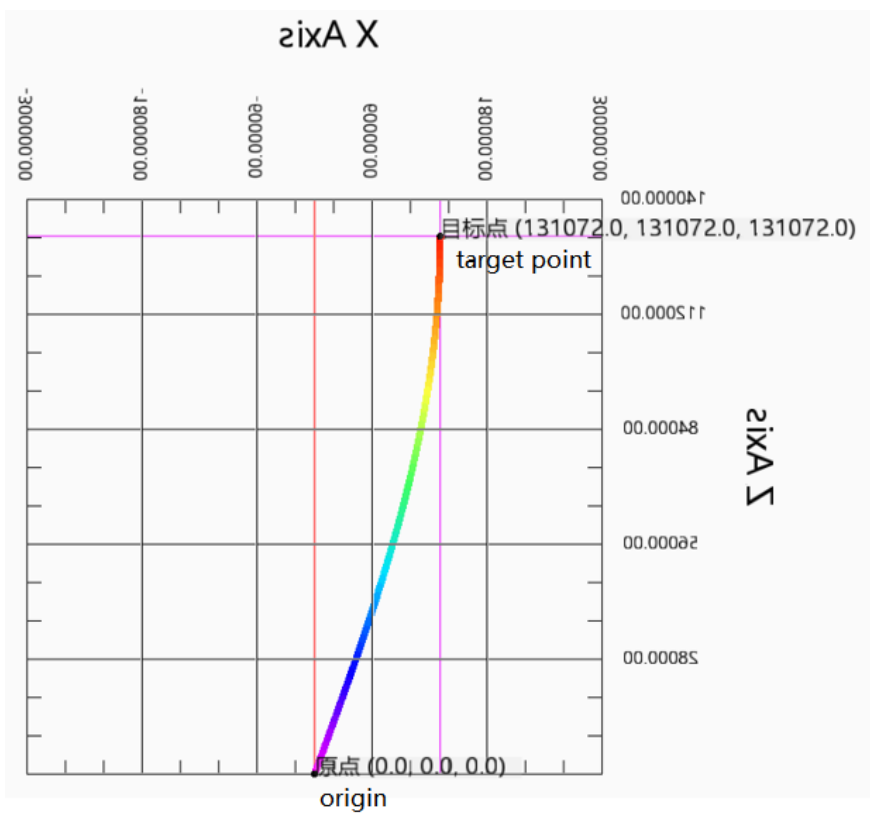
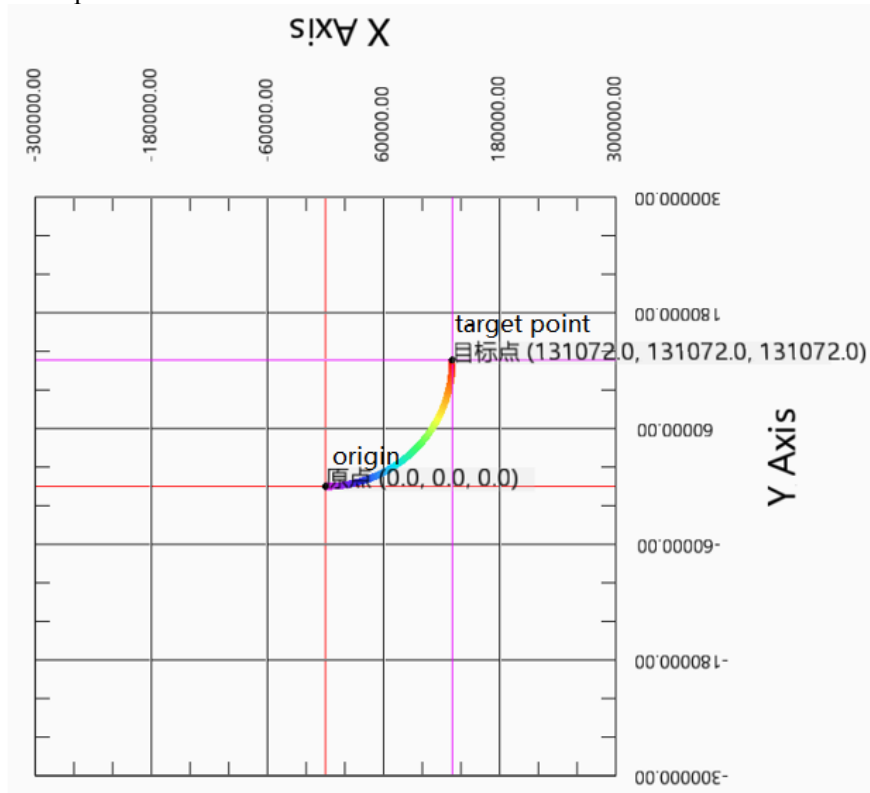

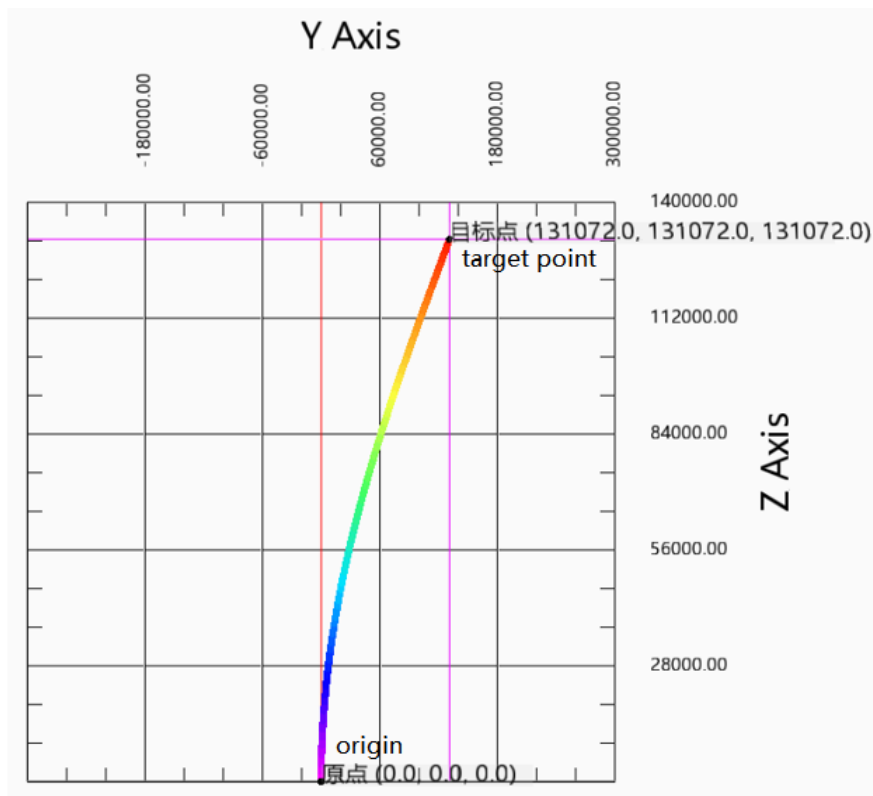

Action decomposition: the two axes of XOY plane perform plane arc action. The arc track consists of the starting point, radius, target coordinates, rotation direction (positive and negative of Z axis) and arc type on the selected plane. The Z-axis moves in a straight line at a uniform speed, and the moving distance is the difference between the starting point of the Z-axis and the target point. The three axes start and stop at the same time, and the three-axis speed is decomposed into XOY plane linear speed and Z-axis linear speed.

5-2-2-7. Superimposed motion 【G_MOVSUP】

(1) Overview

Performs superimposed motion control on the specified axis group.

Superimposed motion [G MOVSUP]			
Execution condition	Rising/falling edge of the coil	Suitable model	XDH, XLH
Firmware	V3.7.1 and above	Software	3.7.4 and above

(2) operand

Operand	Function	Type
S0	Specify the input parameter start address	64-bit, four words
S1	Specify the output state word start address	16-bit, single word
S2	Specify the output state bit start address	Bit
S3	Specify axis output terminal number	16-bit, single word

(3) Suitable soft component

Operand	Word soft component								Bit soft component										
	System								Constant	Module		System							
	D*	FD	TD*	CD*	DX	DY	DM*	DS*	K/H	ID	QD	X	Y	M*	S*	T*	C*		
S0	●	●	●	●	●	●	●	●											
S1	●	●	●	●	●	●	●	●											
S2														●					
S3	●								●										

*: D means D, HD; TD means TD and HTD; CD means CD, HCD, HSCD and HSD; DM means DM and DHM; DS means DS and DHS; M means M, HM, SM; S means S, HS; T means T, HT; C means C, HC.

(4) Function and action

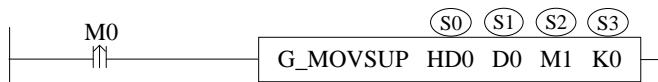

- S0 specifies the input parameter start address
- S1 specifies the output state word start address
- S2 specifies output state bit start address
- S3 specifies the axis output terminal number
- When M0 changes from off to on, the superposition motion control is performed for the specified axis group of S3. The distances of each axis are S0, S0 + 4 and S0 + 8 respectively, the speed is S0 + 24, the acceleration is S0 + 28, the deceleration is S0 + 32 and the jerk speed is S0 + 36. When the command execution is completed, S2 is set to on

(5) Notes

- The command can be carried out simultaneously with the motion command to superimpose the positions of each axis, and the speeds of the two commands will also be superimposed at the same time.
- The compensation value for each axis only takes effect in the current motion, and is invalid after the command ends.
- The instruction can be interrupted by the interrupted mode of the latter instruction, and it is also allowed to follow the cached instruction.
- The effect of executing the instruction alone is consistent with that of LINE instruction.
- The latter instruction can interrupt the previous superimposed instruction.

(6) Related parameters

Input parameter	Parameter name	Data type	Unit	Note
S0	PosX	FP64	-	Position X. The axis number can be set thorough SFD48001+300*N
S0+4	PosY	FP64	-	Position Y. The axis number can be set thorough SFD48002+300*N
S0+8	PosZ	FP64	-	Position Z. The axis number can be set thorough SFD48003+300*N
S0+12	PosA	FP64	-	Position A. Not support at the moment
S0+16	PosB	FP64	-	Position B. Not support at the moment
S0+20	PosZ	FP64	-	Position C. Not support at the moment
S0+24	Vel	FP64	Command unit/s	Speed
S0+28	Acc	FP64	Command unit/s ²	Acceleration
S0+32	Dec	FP64	Command unit/s ²	Deceleration
S0+36	Jerk	FP64	Command unit/s ³	Jerk speed
Output parameter	Parameter name	Data type	Unit	Note
S1	ErrCode	INT16U	-	Command error code
Status parameter	Parameter name	Data type	Unit	Note
S2	Done	BOOL	-	Instruction execution completed
S2+1	Busy	BOOL	-	The instruction is being executed
S2+2	Active	BOOL	-	Command under control
S2+3	Abort	BOOL	-	Instruction is interrupted
S2+4	Error	BOOL	-	Instruction execution error
Axis number	Parameter name	Data type	Unit	Note
S3	Axis	INT16U	-	Axis number starts from 0

***Note:** the relationship between deceleration and jerk speed is same to instruction A_MOVEA, refer to chapter 5-1-2-7 item (5).

(7) Sequence diagram

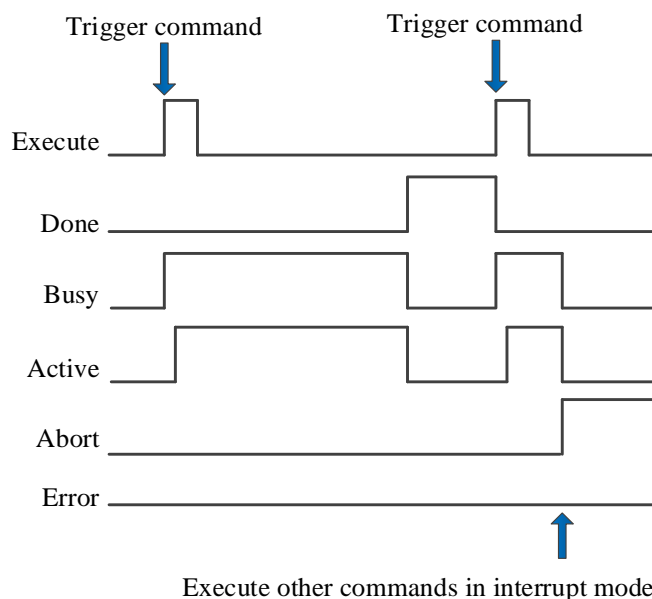

Explanation:

Generally, after the command is triggered, the Busy and Active signals are set, and reset after the command is executed. At the same time, the Done signal is set. Done signal will reset only after the command is triggered again, otherwise it will not reset automatically.

When a new instruction is triggered in interrupt mode during instruction execution, the Busy and Active signals are reset immediately and the Abort signal is set.

When there is an error in the command, the Error signal is set, other signals are reset, and the corresponding error code is output.

(8) Application

For example, the current position of each axis of the axis group is 0, the linear speed 5000 pulse/s, acceleration and deceleration 25000 pulse/ s², jerk speed 50000 pulse/s³, move each axis to the position of 50000, and in the process, the position is superimposed with 20000 by linear speed 5000 pulse/s, acceleration and deceleration 10000 pulse/s², jerk speed 20000 pulse/s³. After the above movement, move to the position of 60000 at the speed of 5000 pulses/s, acceleration and deceleration 25000 pulses/s² and jerk speed 50000 pulses/s³. The ladder diagram is shown in the following figure:

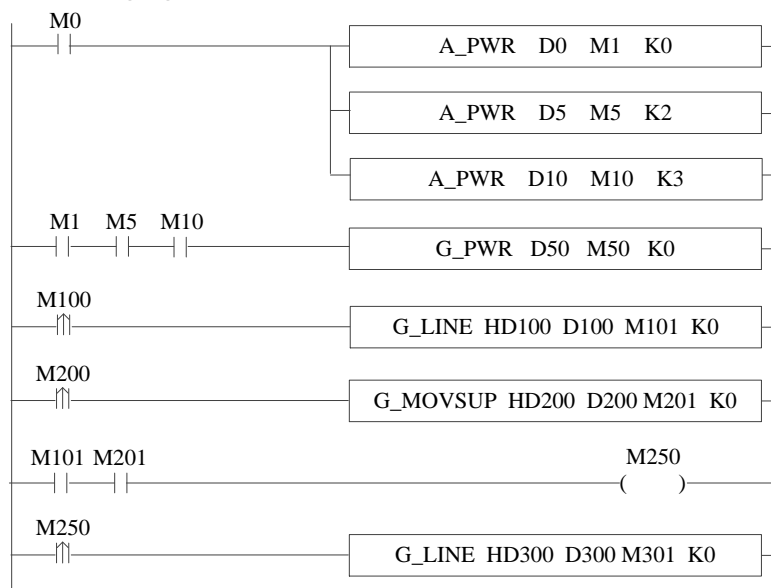

The command configuration is shown as below:

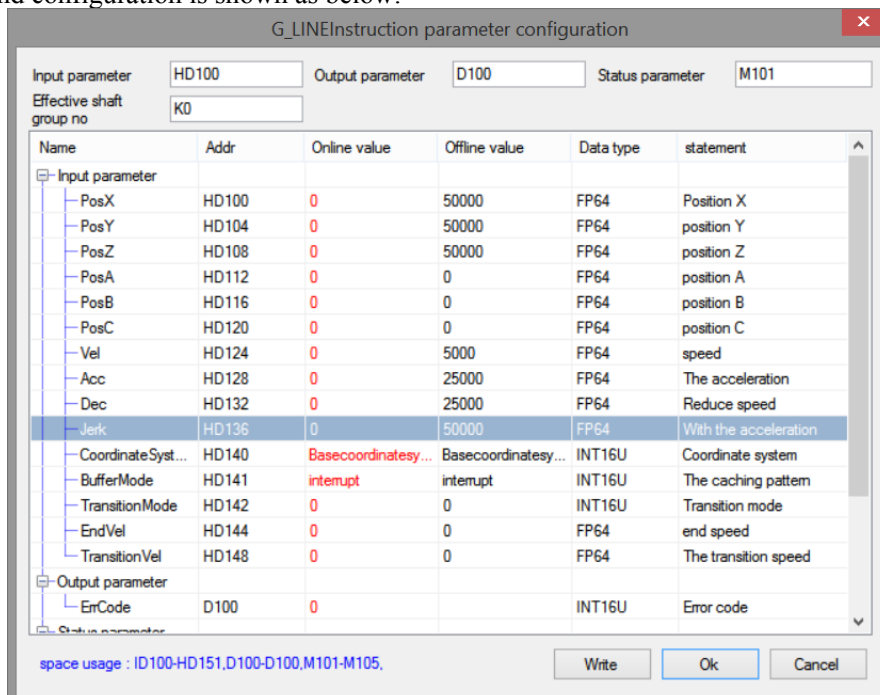

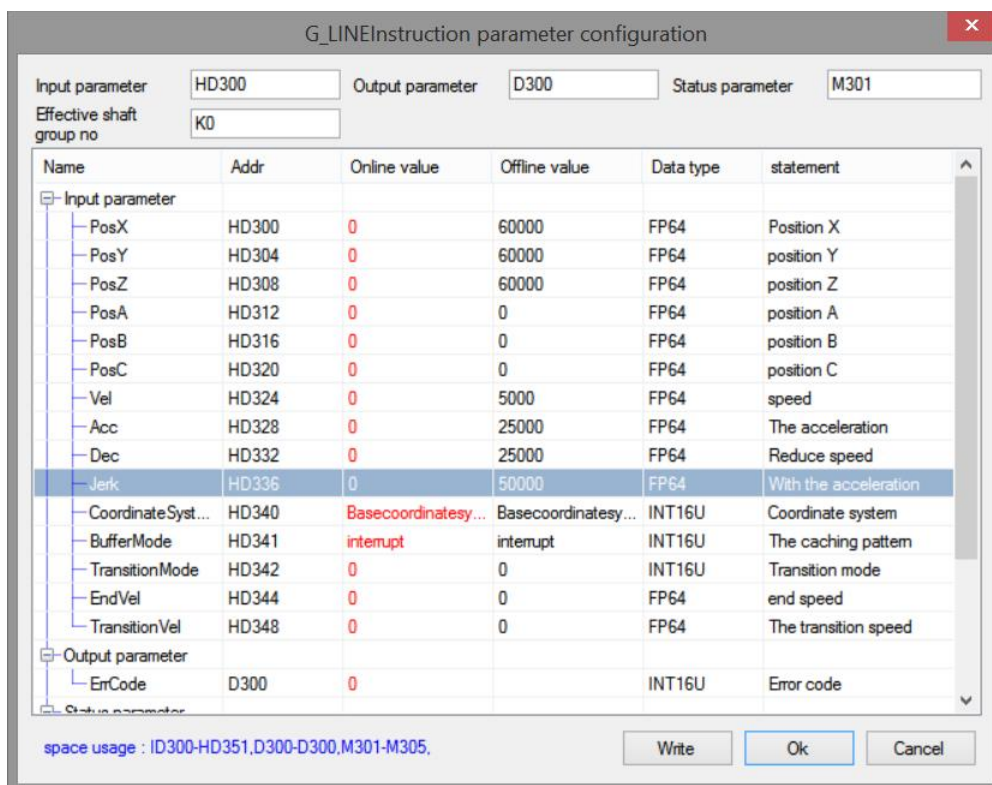
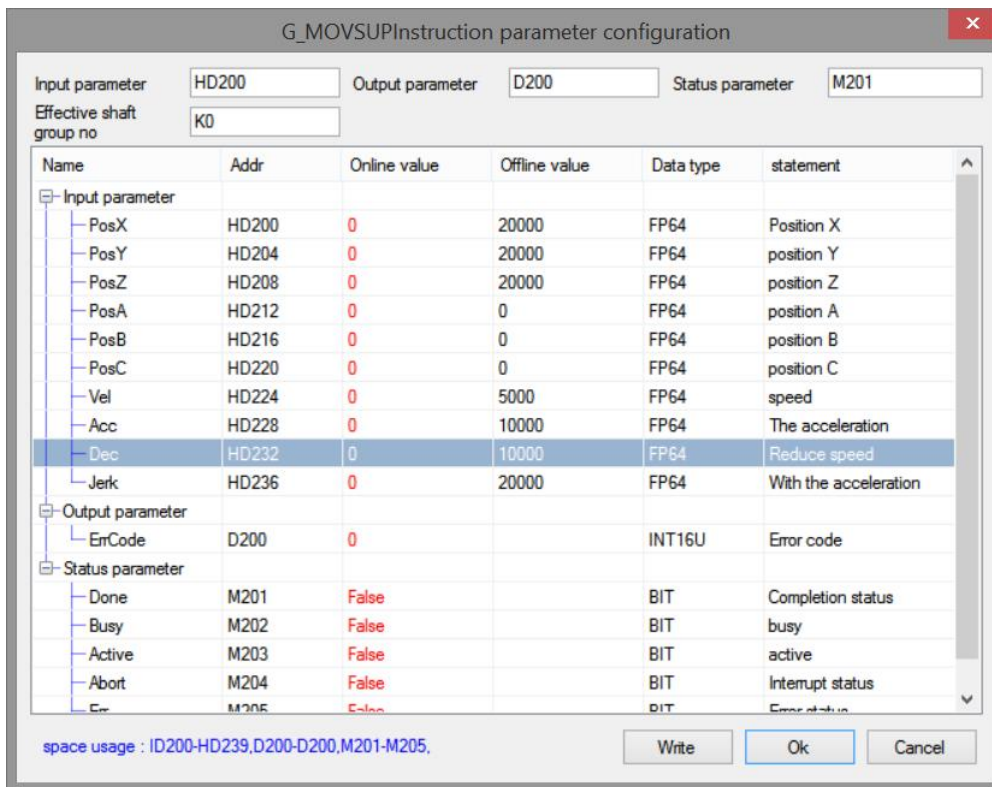

Note: turn on the axis enable through A_PWR. When all the constituent axes of the axis group are enabled, G_PWR is triggered to enable the axis group, turn M100 from off → on, and trigger G_LINE, each axis will move to the position of 50000 with the set parameters. During the axis movement, turn M200 from off → on and trigger G_MOVSUP command, each axis will perform superposition movement with the set parameters. When the movement is over, another G_LINE command will be triggered again immediately.

The position curve is shown as below:

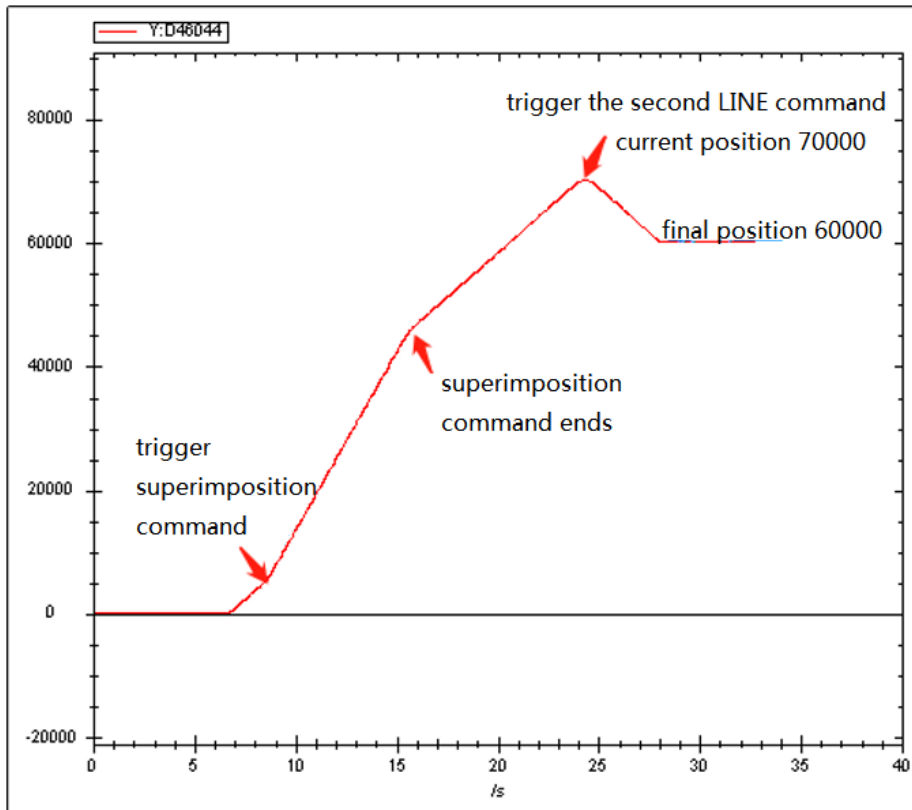

The speed curve is shown as below:

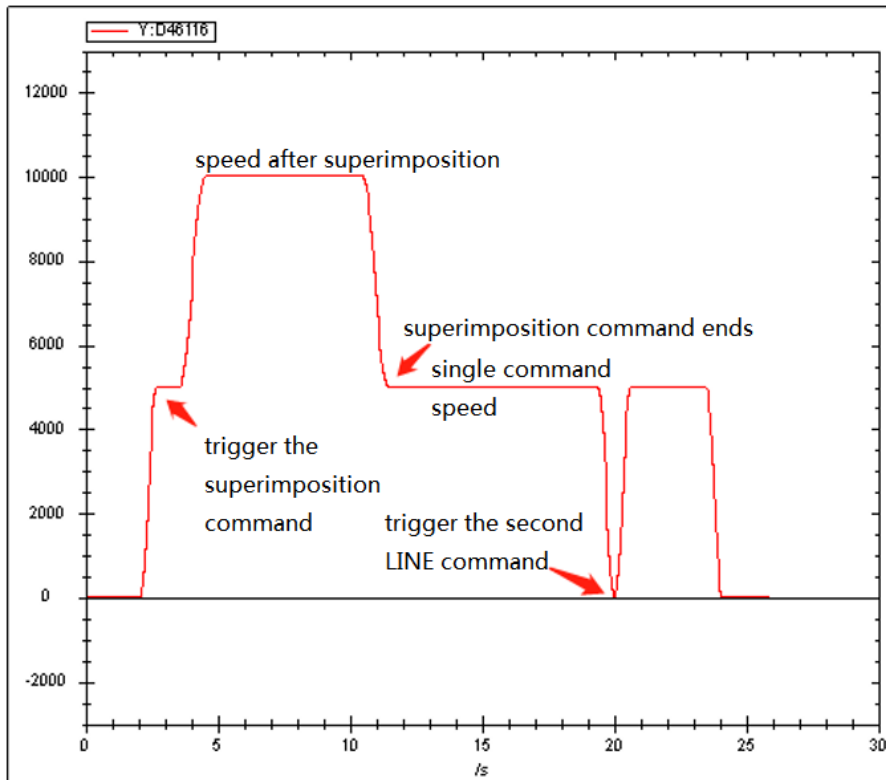

It can be seen from the speed curve that when the superposition instruction is executed, the speed will be superimposed on the basis of the original speed. After the execution of the superposition instruction, the previous speed will continue to execute until the execution of the instruction ends and the speed decreases to 0. It can be seen from the position curve that after the execution of the first instruction and the superimposed instruction, the position is 70000 (including the compensation value of the superimposed instruction to the position of 20000). After the execution of the second LINE instruction, the final position is reduced to 60000, which is consistent with the instruction parameters. Therefore, it can be seen that the compensation of the

superimposed instruction to the position is only effective during the current movement.

5-2-2-8. Compensation motion 【G_COMPON】

(1) Overview

Compensation motion control for the specified axis.

Compensation motion [G_COMPON]			
Execution condition	Rising/falling edge of the coil	Suitable model	XDH, XLH
Firmware	V3.7.1 and above	Software	V3.7.4 and above

(2) operand

Operand	Function	Type
S0	Specify the input parameter start address	64-bit, four words
S1	Specify the output state word start address	16-bit, single word
S2	Specify the output state bit start address	Bit
S3	Specify axis output terminal number	16-bit, single word

(3) Suitable soft component

Operand	Word soft component								Bit soft component										
	System								Constant	Module		System							
	D*	FD	TD*	CD*	DX	DY	DM*	DS*	K/H	ID	QD	X	Y	M*	S*	T*	C*		
S0	●	●	●	●	●	●	●	●											
S1	●	●	●	●	●	●	●	●											
S2														●					
S3	●								●										

*: D means D, HD; TD means TD and HTD; CD means CD, HCD, HSCD and HSD; DM means DM and DHM; DS means DS and DHS; M means M, HM, SM; S means S, HS; T means T, HT; C means C, HC.

(4) Action and function



- S0 specifies the input parameter start address
- S1 specifies the output state word start address
- S2 specifies output state bit start address
- S3 specifies the axis output terminal number
- Trigger the command to perform compensation motion control on the designated axis of S3. The distance of each axis is S0, S0 + 4 and S0 + 8, the speed is S0 + 24, the acceleration is S0 + 28, the deceleration is S0 + 32 and the jerk speed is S0 + 36. When the command is executed, S2 is set to on

(5) Notes

- The command is triggered after the motion command and can be executed together with other motion commands to make compensation motion for each axis position, and the two command speeds will be superimposed at the same time. When the instruction is executed separately, the effect is the same as that of the LINE instruction.
- After the command movement is completed, it will compensate all subsequent movements, and the compensation value can only be cancelled by the compensation cancellation command COMPON.
- Other commands cannot interrupt the compensation movement of this command and will move together with the compensation command. Only the compensation instruction itself can interrupt the compensation instruction.
- The compensation position type can be divided into absolute value and relative value.
- When the instruction is interrupted, the compensation amount of the current segment will be written into the system.

(6) Related parameters

Input parameter	Parameter name	Data type	Unit	Note
S0	PosX	FP64	-	Position X. The axis number is set through SFD48001+300*N
S0+4	PosY	FP64	-	Position Y. The axis number is set through SFD48002+300*N
S0+8	PosZ	FP64	-	Position Z. The axis number is set through SFD48003+300*N
S0+12	PosA	FP64	-	Position A. Not support at the moment
S0+16	PosB	FP64	-	Position B. Not support at the moment
S0+20	PosC	FP64	-	Position C. Not support at the moment
S0+24	Vel	FP64	Command unit/s	Speed
S0+28	Acc	FP64	Command unit /s ²	Acceleration
S0+32	Dec	FP64	Command unit /s ²	Deceleration
S0+36	Jerk	FP64	Command unit /s ³	Jerk speed
S0+40	MotionType	INT16U	-	Position type
Output parameter	Parameter name	Data type	Unit	Note
S1	ErrCode	INT16U	-	Command error code
Status parameter	Parameter name	Data type	Unit	Note
S2	Done	BOOL	-	Instruction execution completed
S2+1	Busy	BOOL	-	The instruction is being executed
S2+2	Active	BOOL	-	Command under control
S2+3	Abort	BOOL	-	Instruction is interrupted
S2+4	Error	BOOL	-	Instruction execution error
Axis number	Parameter name	Data type	Unit	Note
S3	Axis	INT16U	-	Axis number starts from 0

***Note:** the relationship between deceleration and jerk speed is same to instruction A_MOVEA, refer to chapter 5-1-2-7 item (5).

(7) Sequence diagram

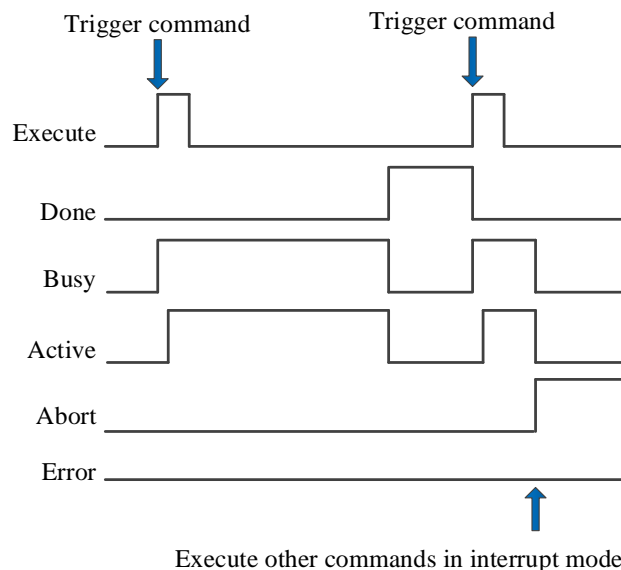

Explanation:

Generally, after the command is triggered, the Busy and Active signals are set, and reset after the command is executed. At the same time, the Done signal is set. Done signal will reset only after the command is triggered again, otherwise it will not reset automatically.

When a new instruction is triggered in interrupt mode during instruction execution, the Busy and Active signals are reset immediately and the Abort signal is set.

When there is an error in the command, the Error signal is set, other signals are reset, and the corresponding error code is output.

(8) Application

For example, the current position of each axis of the axis group is 0, the linear speed is 5000 pulse/s, the acceleration and deceleration is 2500 pulse/s², and the jerk speed is 50000 pulse/s³, and each axis moves to the position of 50000. In the process, the position is superimposed with 20000 by the linear speed of 5000 pulse/s, the acceleration and deceleration 10000 pulse/s², and the jerk speed 20000 pulse/s³. After the above movement, it moves to the position of 60000 at the speed of 5000 pulses/s, acceleration and deceleration 2500 pulses/s² and jerk speed 50000 pulses/s³. The ladder diagram is shown in the following figure:

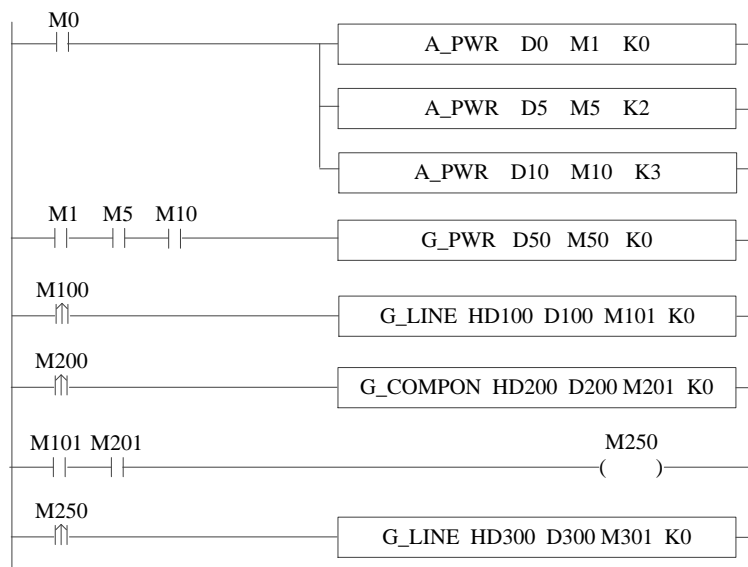

The command configuration is shown as below:

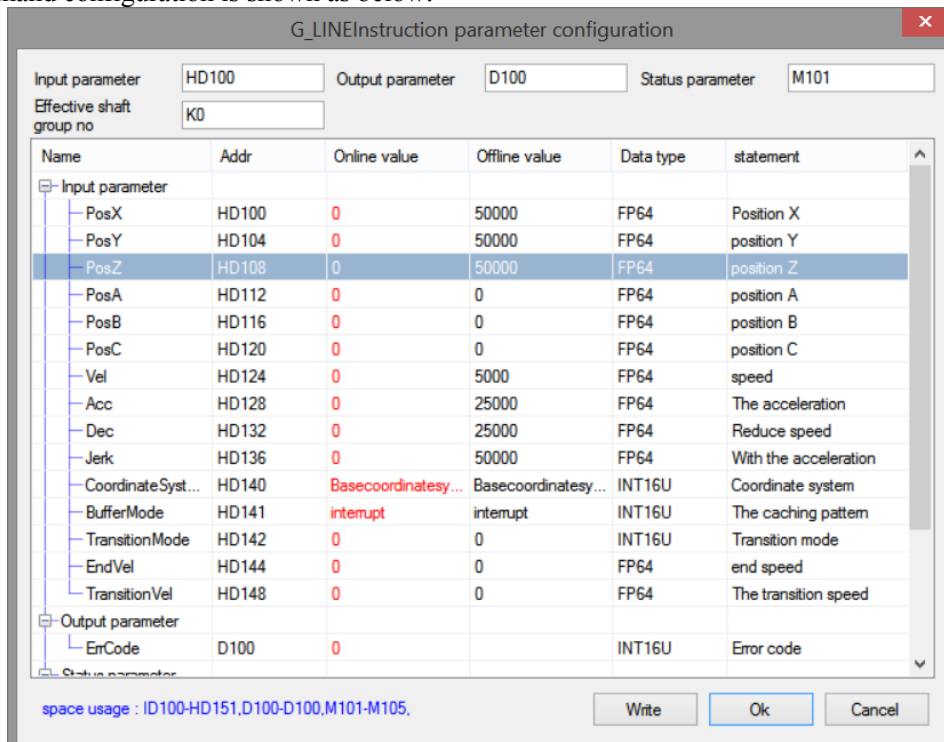

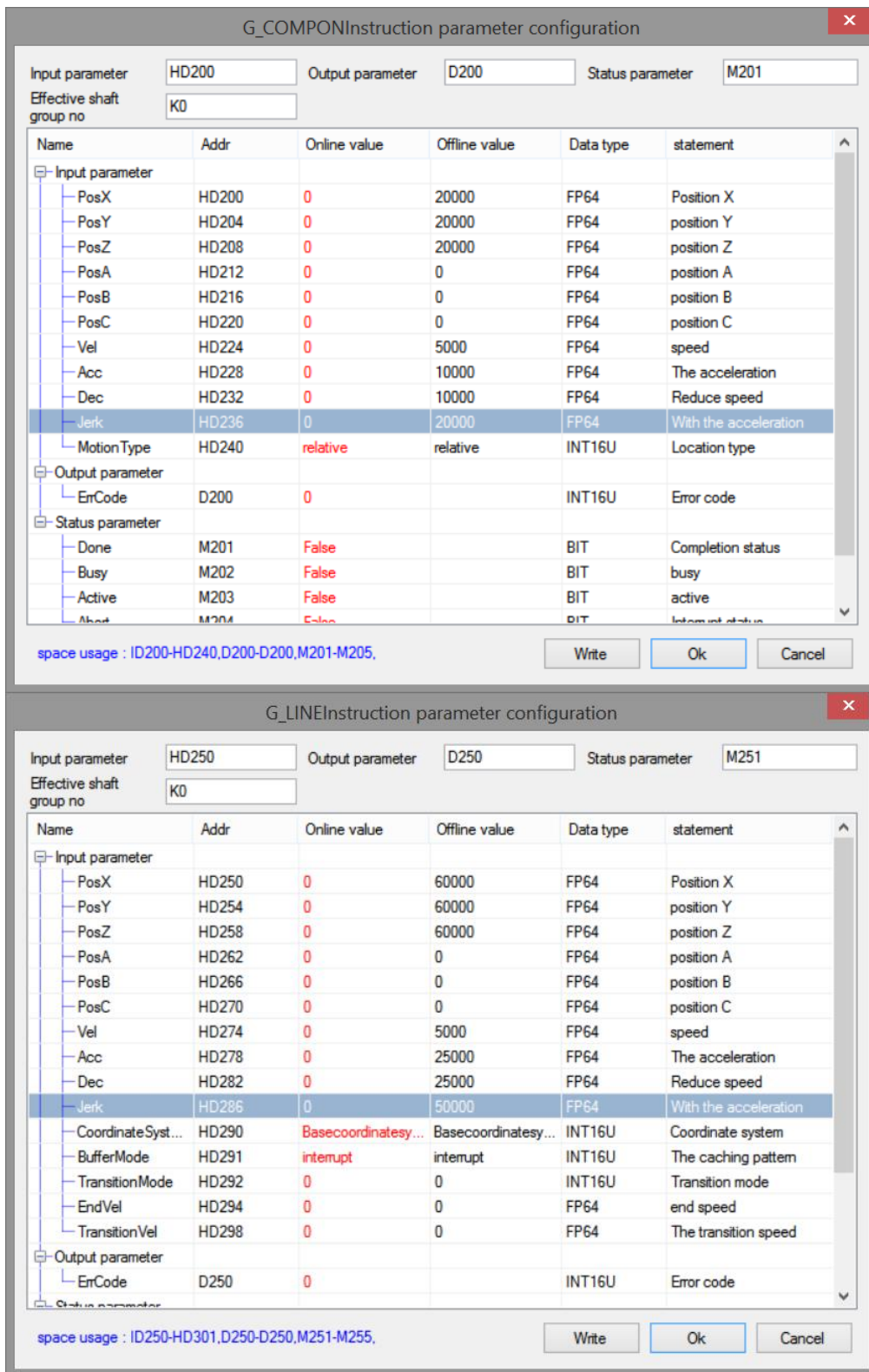

Explanation:

Turn on the axis enable through A_PWR, when all the constituent axes of the axis group are enabled, G_PWR is triggered to enable the axis group. M100 is from OFF→ON, command G_LINE is triggered, each axis moves to position 50000 with the set parameters. In the axis motion process, M200 is from OFF→ON, command G_COMPO is triggered, each axis will perform superimposed motion with the set parameters. When the movement is over, another G_LINE will be triggered again immediately.

The position curve is shown as below:

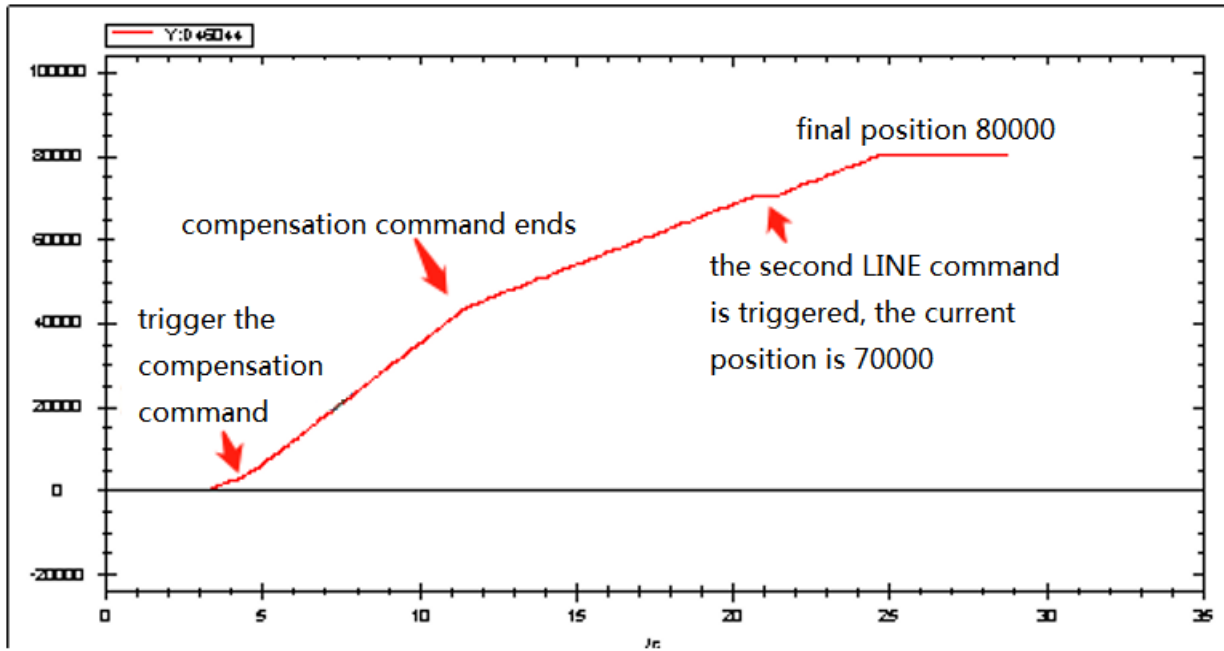

The speed curve is shown as below:

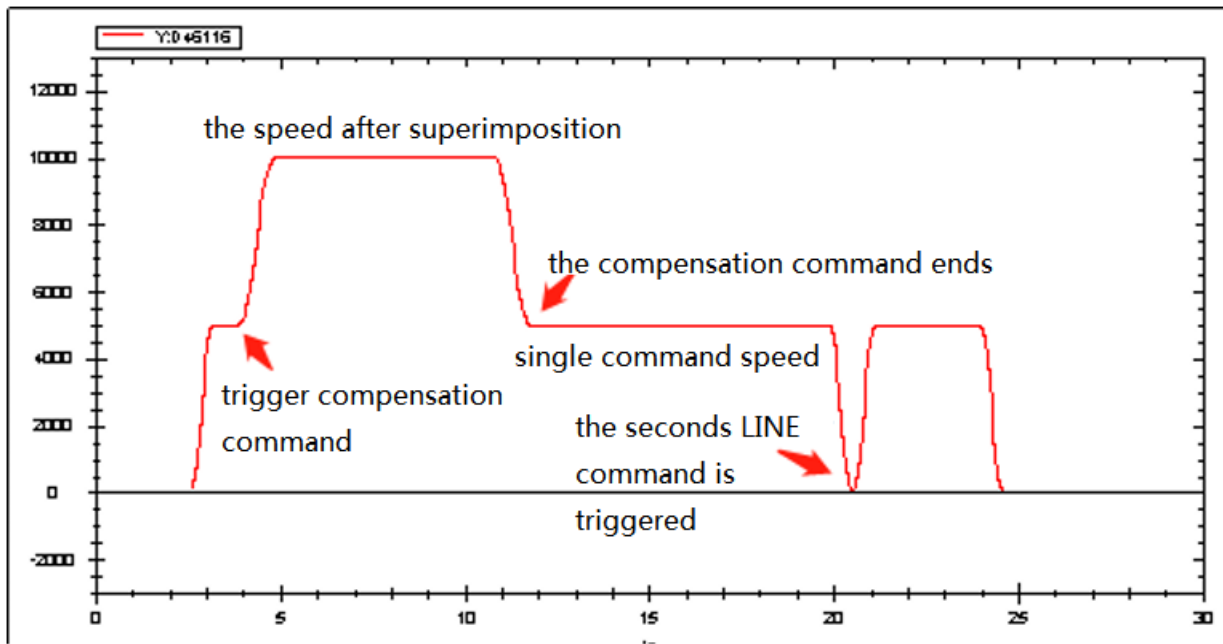

It can be seen from the position curve that after the execution of the first instruction and the superimposed instruction, the position is 70000 (including the compensation value of the superimposed instruction to the position of 20000), and after the execution of the second line instruction, the final position is 80000 (the instruction parameter is 60000), so it can be seen that the compensation of the compensation instruction to the position is always effective.

5-2-2-9. Compensation cancellation 【G_COMPOFF】

(1) Overview

Cancel the compensation value for the specified axis group.

Cancel the compensation [G_COMPOFF]			
Execution condition	Rising/falling edge of the coil	Suitable model	XDH, XLH
Firmware	V3.7.1 and above	Software	3.7.4 and above

(2) operand

Operand	Function	Type
S0	Specify the output state word start address	16-bit, single word
S1	Specify the output state bit start address	Bit
S2	Specify axis output terminal number	16-bit, single word

(3) Suitable soft component

Operand	Word soft component								Bit soft component										
	System								Constant	Module		System							
	D*	FD	TD*	CD*	DX	DY	DM*	DS*	K/H	ID	QD	X	Y	M*	S*	T*	C*		
S0	●	●	●	●	●	●	●	●											
S1														●					
S2	●								●										

*: D means D, HD; TD means TD and HTD; CD means CD, HCD, HSCD and HSD; DM means DM and DHM; DS means DS and DHS; M means M, HM, SM; S means S, HS; T means T, HT; C means C, HC.

(4) Function and action



- S0 specifies the output state word start address
- S1 specifies output state bit start address
- S2 specifies the axis output terminal number
- When M0 is from off → on, cancel the internal compensation value of each component axis of the axis group specified by S3 and reset to 0
- This command can only be executed when the axis group is idle, otherwise the command will report an error

(5) Related parameters

Output parameter	Parameter name	Data type	Unit	Note
S0	ErrCode	INT16U	-	Command error code
State parameter	Parameter name	Data type	Unit	Note
S1	Done	BOOL	-	Instruction execution completed
S1+1	Busy	BOOL	-	The instruction is being executed
S1+2	Abort	BOOL	-	Instruction is interrupted
S1+3	Error	BOOL	-	Instruction execution error
Axis number	Parameter name	Data type	Unit	Note
S2	Axis	INT16U	-	Axis number starts from 0

(6) sequence diagram

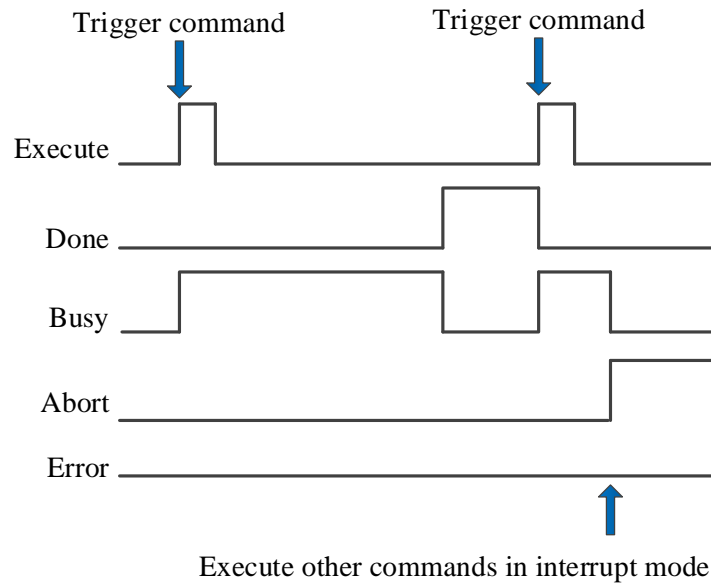

Explanation:

Generally, after the command is triggered, the Busy signal is set, reset after the command is completed, and the Done signal is set. Done is reset only after the command is triggered again, otherwise it will not be reset automatically.

When the instruction is interrupted or has an error, the corresponding Abort or Error signal is set, other signals are reset, and the corresponding error code will be output in case of error.

5-2-2-10. Interrupt motion 【G_INTR】

(1) Overview

The axis group pauses with the set parameters.

Interrupt motion [G_INTR]			
Execution condition	Rising/falling edge of the coil	Suitable model	XDH, XLH
Firmware	V3.6.1b and above	Software	V3.7.4 and above

(2) operand

Operand	Function	Type
S0	Specify the input parameter start address	64-bit, four words
S1	Specify the output state word start address	16-bit, single word
S2	Specify the output state bit start address	Bit
S3	Specify axis group number	16-bit, single word

(3) Suitable soft component

Operand	Word soft component										Bit soft component						
	System								Constant	Module		System					
	D*	FD	TD*	CD*	DX	DY	DM*	DS*	K/H	ID	QD	X	Y	M*	S*	T*	C*
S0	●	●	●	●	●	●	●	●									
S1	●	●	●	●	●	●	●	●									
S2														●			
S3	●								●								

*: D means D, HD; TD means TD and HTD; CD means CD, HCD, HSCD and HSD; DM means DM and DHM; DS means DS and DHS; M means M, HM, SM; S means S, HS; T means T, HT; C means C, HC.

(4) Function and action



- S0 specifies the input parameter start address, occupies the register S0~S0+7
- S1 specifies the output state word start address
- S2 specifies output state bit start address, occupies the relay S2~S2+4
- S3 specifies the axis group number, starts from 0. The axis number in the axis group is set through $SFD48001+300*N \sim SFD48006+300*N$, N is axis group number
- When M0 is from OFF→ON, the axis group specified by S3 performs arc interpolation with the deceleration, acceleration and jerk speed set by the user

(5) Notes

- G_INTR can pause the command in motion and let the command state output Abort, and the actual deceleration is the larger value between G_INTR and the command in motion.
- G_INTR does not support buffer mode and cannot execute other command in buffer mode when G_INTR is being executed.

(6) Related parameters

Input parameter	Parameter name	Data type	Unit	Note
S0	Deceleration	FP64	Command unit/s ²	Target deceleration
S0+4	Jerk	FP64	Command unit/s ³	Target jerk speed, the change rate of acceleration/deceleration
Output parameter	Parameter name	Data type	Unit	Note

S1	ErrCode	INT16U	-	Command error code
State parameter	Parameter name	Data type	Unit	Note
S2	Done	BOOL	-	Instruction execution completed
S2+1	Busy	BOOL	-	The instruction is being executed
S2+2	Active	BOOL	-	Command under control
S2+3	Abort	BOOL	-	Instruction is interrupted
S2+4	Error	BOOL	-	Instruction execution error
Axis number	Parameter name	Data type	Unit	Note
S3	Axis	INT16U	-	Axis group number starts from 0

(7) Sequence diagram

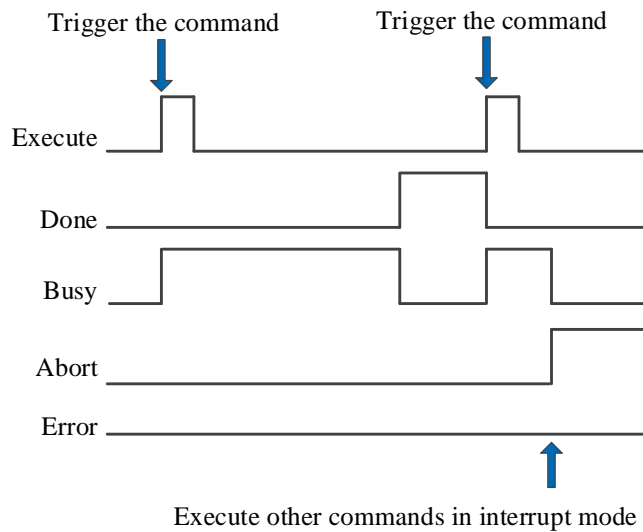

Explanation:

Generally, after the command is triggered, the Busy signal is set, reset after the command is completed, and the Done signal is set. Done is reset only after the command is triggered again, otherwise it will not be reset automatically.

When the instruction is interrupted or has an error, the corresponding Abort or Error signal is set, other signals are reset, and the corresponding error code will be output in case of error.

5-2-2-11. Continue the motion 【G_GOON】

(1) Overview

The suspended axis group continues its original motion.

Continue the motion [G_GOON]			
Execution condition	Rising/falling edge of the coil	Suitable model	XDH, XLH
Firmware	V3.6.1b and above	Software	V3.7.4 and above

(2) operand

Operand	Function	Type
S0	Specify the output state word start address	16-bit, single word
S1	Specify the output state bit start address	Bit
S2	Specify axis group number	16-bit, single word

(3) Suitable soft component

Operand	Word soft component										Bit soft component						
	System								Constant	Module		System					
	D*	FD	TD*	CD*	DX	DY	DM*	DS*	K/H	ID	QD	X	Y	M*	S*	T*	C*
S0	●	●	●	●	●	●	●	●									
S1														●			
S2	●								●								

*: D means D, HD; TD means TD and HTD; CD means CD, HCD, HSCD and HSD; DM means DM and DHM; DS means DS and DHS; M means M, HM, SM; S means S, HS; T means T, HT; C means C, HC.

(4) Function and action



- S0 specifies the output state word start address
- S1 specifies output state bit start address, occupies the relay S2~S2+3
- S2 specifies the axis group number
- When M0 is from OFF→ON, the axis group specified by S2 continues the motion according to the original curve
- After the command is executed, the single axis state of axis group (D20000+200*N) is 8, the axis group state (D46000+300*N) is 2

(5) Notes

- G_GOON must be used together with G_INTR, G_GOON can be used only after the axis group is suspended.
- G_GOON cannot make G_PATHMOV continues to move and can trigger G_PATHMOV instruction to realize continuous movement.
- G_GOON does not support buffer mode and other commands cannot be executed in buffer mode when G_GOON is running.
- The acceleration and deceleration when continuing the movement shall be carried out according to the original track.

(6) Related parameters

Output parameter	Parameter name	Data type	Unit	Note
S0	ErrCode	INT16U	-	Command error code
State parameter	Parameter name	Data type	Unit	Note
S1	Done	BOOL	-	Instruction execution completed

S1+1	Busy	BOOL	-	The instruction is being executed
S1+2	Abort	BOOL	-	Instruction is interrupted
S1+3	Error	BOOL	-	Instruction execution error
Axis number	Parameter name	Data type	Unit	Note
S2	Axis	INT16U	-	The axis group number starts from 0

(7) Sequence diagram

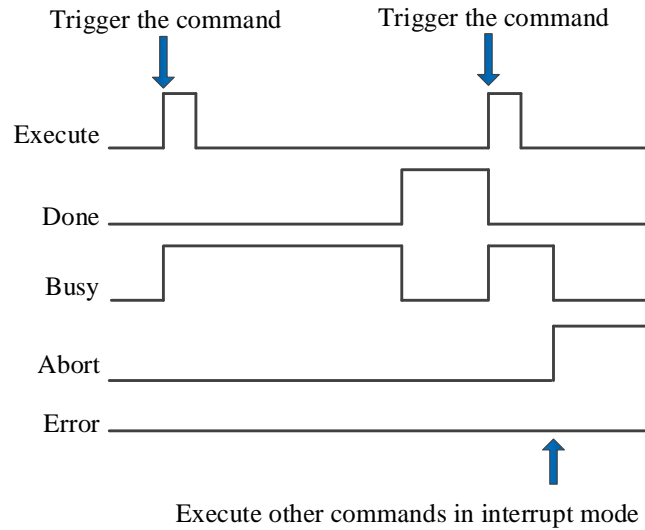

Explanation:

Generally, after the command is triggered, the Busy signal is set, reset after the command is completed, and the Done signal is set. Done is reset only after the command is triggered again, otherwise it will not be reset automatically.

When the instruction is interrupted or has an error, the corresponding Abort or Error signal is set, other signals are reset, and the corresponding error code will be output in case of error.

5-2-2-12. Specified path mode selection 【G_PATHMODE】

(1) Overview

Specify the motion mode when the axis group path moves.

Specified path mode selection [G_PATHMODE]			
Execution condition	Rising/falling edge of the coil	Suitable model	XDH, XLH
Firmware	V3.7.1 and above	Software	V3.7.4 and above

(2) operand

Operand	Function	Type
S0	Specify the input parameter start address	64-bit, four words
S1	Specify the output state word start address	16-bit, single word
S2	Specify the output state bit start address	Bit
S3	Specify axis output terminal number	16-bit, single word

(3) Suitable soft component

Operand	Word soft component								Bit soft component										
	System								Constant	Module		System							
	D*	FD	TD*	CD*	DX	DY	DM*	DS*	K/H	ID	QD	X	Y	M*	S*	T*	C*		
S0	●	●	●	●	●	●	●	●											
S1	●	●	●	●	●	●	●	●											
S2														●					
S3	●								●										

*: D means D, HD; TD means TD and HTD; CD means CD, HCD, HSCD and HSD; DM means DM and DHM; DS means DS and DHS; M means M, HM, SM; S means S, HS; T means T, HT; C means C, HC.

(4) Function and action



- S0 specifies the input parameter start address
- S1 specifies the output state word start address
- S2 specifies output state bit start address
- S3 specifies the axis output terminal number
- When M0 is from OFF→ON, select the execution mode of PATHMOV, the mode is decided by the command parameter [mode selection] of PATHMODE

(5) Notes

- When the mode is handwheel mode, the forward-looking parameters [handwheel maximum speed], [handwheel maximum acceleration], [handwheel high speed counting port], [handwheel pulse equivalent] in the axis group configuration need to be configured.
- In the handwheel mode, the hand pulse needs to be connected to the corresponding high-speed counting port, the PATHMOV command is triggered, the hand pulse is rotated, and the axis starts to move in the specified path.
- When the mode is not selected through this command, the PATHMOV command is executed in the automatic mode by default, that is, after the command is triggered, the axis will execute automatically according to the planned path.

(6) Related parameters

Input parameter	Parameter name	Data type	Unit	Note
S0	Mode	INT16U	Command unit/s	Mode selection. 0 - automatic mode 1 - handwheel mode
Output parameter	Parameter name	Data type	Unit	Note
S1	ErrCode	INT16U	-	Command error code
State parameter	Parameter name	Data type	Unit	Note
S2	Done	BOOL	-	Instruction execution completed
S2+1	Busy	BOOL	-	The instruction is being executed
S2+2	Abort	BOOL	-	Instruction is interrupted
S2+3	Error	BOOL	-	Instruction execution error
Axis number	Parameter name	Data type	Unit	Note
S3	Axis	INT16U	-	Axis number starts from 0

(7) Sequence diagram

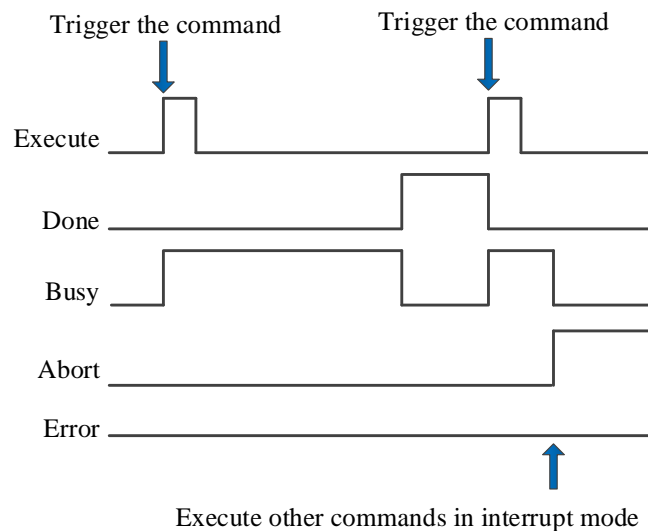

Explanation:

Generally, after the command is triggered, the Busy signal is set, reset after the command is completed, and the Done signal is set. Done is reset only after the command is triggered again, otherwise it will not be reset automatically.

When the instruction is interrupted or has an error, the corresponding Abort or Error signal is set, other signals are reset, and the corresponding error code will be output in case of error.

5-2-2-13. Select machining path 【G_PATHSEL】

(1) Overview

Set the machining path, moves through the command G_PATHMOV.

Select machining path [G_PATHSEL]			
Execution condition	Rising/falling edge of the coil	Suitable model	XDH, XLH
Firmware	V3.6.1b and above	Software	V3.7.4 and above

(2) operand

Operand	Function	Type
S0	Specify the input parameter start address	16-bit, single word
S1	Specify the output state word start address	16-bit, single word
S2	Specify the output state bit start address	Bit
S3	Specify axis group number	16-bit, single word

(3) Suitable soft component

Operand	Word soft component								Bit soft component								
	System								Constant	Module		System					
	D*	FD	TD*	CD*	DX	DY	DM*	DS*	K/H	ID	QD	X	Y	M*	S*	T*	C*
S0	●	●	●	●	●	●	●	●									
S1	●	●	●	●	●	●	●	●									
S2														●			
S3	●								●								

*: D means D, HD; TD means TD and HTD; CD means CD, HCD, HSCD and HSD; DM means DM and DHM; DS means DS and DHS; M means M, HM, SM; S means S, HS; T means T, HT; C means C, HC.

(4) Function and action



- S0 specifies the input parameter start address, occupies the register S0~S0+10+60*n, n is the data row numbers
- S1 specifies the output state word start address
- S2 specifies output state bit start address, occupies the relay S2~S2+3
- S3 specifies the axis group number
- When M0 is from OFF→ON, set the machining path as the set parameters, run the machining path through the command G_PATHMOV

(5) Related parameters

Input parameter	Parameter name	Data type	Unit	Note
S0	Quantity	INT16U	-	Data row numbers n
S0+1	Reload	INT16U	-	Reload 0: continue loading 1: reload
S0+10+60* (n-1)	Index	INT32U	-	The row number of this segment track data. The parameter value shall be greater than the previous row number and greater than 0.
S0+12+60* (n-1)	Type	INT16U	-	Data type 0: PTP 1: LINE 2: CIRCLR

Input parameter	Parameter name	Data type	Unit	Note
				100: user defined 200: end row
S0+13+60* (n-1)	Parameter	INT16U	-	Data type 2: 0 three-point arc, others cannot support at the moment 1 2 Data type 100: M code value ≥ 100
S0+15+60* (n-1)	Coordinatesystemn	INT16U	-	Coordinate system. Not supported at the moment
S0+16+60* (n-1)	PositionX	FP64	Command unit	X axis target position. N is data row numbers
S0+20+60* (n-1)	PositionY	FP64	Command unit	Y axis target position. N is data row numbers
S0+24+60* (n-1)	PositionZ	FP64	Command unit	Z axis target position. N is data row numbers
S0+28+60* (n-1)	PositionA	FP64	Command unit	A axis target position. Not supported at the moment
S0+32+60* (n-1)	PositionB	FP64	Command unit	B axis target position. Not supported at the moment
S0+36+60* (n-1)	PositionC	FP64	Command unit	C axis target position. Not supported at the moment
S0+40+60* (n-1)	AuxiliaryX	FP64	Command unit	X axis auxiliary point position. N is data row numbers. Only valid in data type CIRCLE
S0+44+60* (n-1)	AuxiliaryY	FP64	Command unit	Y axis auxiliary point position. N is data row numbers. Only valid in data type CIRCLE
S0+48+60* (n-1)	AuxiliaryZ	FP64	Command unit	Z axis auxiliary point position. N is data row numbers. Only valid in data type CIRCLE
S0+52+60* (n-1)	AuxiliaryA	FP64	Command unit	A axis auxiliary point position. Not supported at the moment
S0+56+60* (n-1)	AuxiliaryB	FP64	Command unit	B axis auxiliary point position. N is data row numbers
S0+60+60* (n-1)	AuxiliaryC	FP64	Command unit	C axis auxiliary point position. N is data row numbers
S0+64+60* (n-1)	Velocity	FP64	Command unit /s	Target speed
Output parameter	Parameter name	Data type	Unit	Note
S1	ErrCode	INT16U	-	Command error code
State parameter	Parameter name	Data type	Unit	Note
S2	Done	BOOL	-	Instruction execution completed
S2+1	Busy	BOOL	-	The instruction is being executed
S2+2	Abort	BOOL	-	Instruction is interrupted
S2+3	Error	BOOL	-	Instruction execution error
Axis number	Parameter name	Data type	Unit	Note
S3	Axis	INT16U	-	Axis group number starts from 0

- The speed set by the user is the parameter of the axis group. If the parameter set by the user is greater than the maximum parameter value of the axis group, it will be treated as the maximum parameter value of the axis group. If the parameter value set by the user is greater than the maximum parameter value of each single

axis, the linear speed and other parameters of the axis group will be calculated based on the maximum parameter value of the single axis.

- The data row value must be greater than or equal to 0, but not exceed the remaining size of the buffer. The remaining size of the buffer can be determined by D46226. This register takes effect after the axis group is enabled.
- When the parameter is set to 0, the instruction execution will store the data in the buffer, when the G_PATHMOV instruction is executed, it will move with the data in the buffer. When the parameter is set to 1, the instruction execution will clear the data in the buffer and reload the current data. When the number of data rows is set to 0 and whether to reload is set to 1, instruction execution will empty the buffer. The remaining space of the buffer is determined by $D46226+300*N$.
- The row number is set by the customer, but the row number must be monotonically increasing, and the row number of the first line cannot be 0.
- When the data type is PTP, it will move separately at the default speed of each axis (the same as G_PTP).
- The data type 100 is a user-defined type. It takes effect when the set parameter is greater than 100. When the parameter is set to 1000 ~ 1999, it is a non-stop M code, that is, when moving to this point, the axis group will not stop moving and continue to execute the next track. The M code will follow the previous track and be stored in the corresponding register. When the parameter is not within the range of 1000 ~ 1999, this point is non-motion. When the command is executed to this point, it will stop and set on M28010. Manually set M28010 to off and continue to execute the following points.
- If the data type is set to 200, it indicates the end row of the current behavior, G_PATHSEL can be loaded multiple times, or all points can be set for loading at one time. New point can be loaded when G_PATHSEL is running, and setting the data type to 200 indicates the end of operation. Executing G_PATHSEL must have an end row.
- The auxiliary point parameter is valid only when the data type is CIRCLE.

(6) Sequence diagram

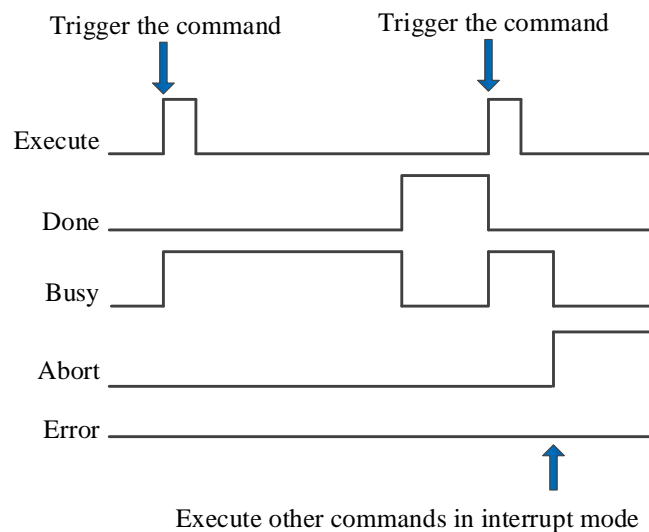

Explanation:

Generally, after the command is triggered, the Busy signal is set, reset after the command is completed, and the Done signal is set. Done is reset only after the command is triggered again, otherwise it will not be reset automatically.

When the instruction is interrupted or has an error, the corresponding Abort or Error signal is set, other signals are reset, and the corresponding error code will be output in case of error.

(7) Application

Load 3 rows of data (the third row is end row). The ladder diagram is as the following:

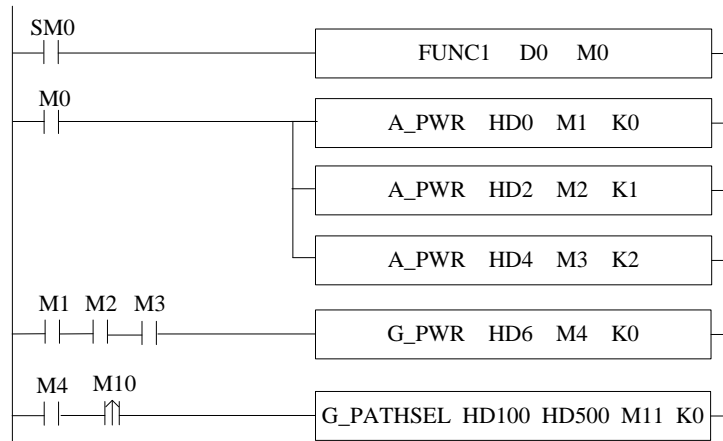

Among them, FUNC1 is to set the value for command G_PATHSEL. When M0 is on, each axis of axis group is enabled, after all three axis enable are turned on successfully (M1, M2 and M3 are on), the axis group is enabled. After the axis group is enabled successfully (M4 is on), M10 is from off → on, G_PATHSEL instruction is triggered. The instruction can load all points in a single time or a certain number of points in multiple times, but there must be at least one end row to execute G_PATHMOV.

Single time loading:

```
9 void FUNC1( WORD W , BIT B )
10 {
11 #define SysRegAddr_HD_D_HM_M
12 #define DFHD *(FP64*)&HD
13
14 //set value for G PATHSEL
15 HD[100] = 3; //data row numbers
16 HD[101] = 0; //0: continue insert 1:reload
17
18 HD[110] = 1; //row number 1
19 HD[112] = 1; //type (0:PTP 1:LINE 2:CIRCLE 100:user defined 200:end row)
20 HD[113] = 0; //parameters
21 DFHD[116] = 100000; //target position X
22 DFHD[120] = 100000; //target position Y
23 DFHD[124] = 0; //target position Z
24 DFHD[164] = 20000; //target speed
25
26 HD[170] = 2; //row number 2
27 HD[172] = 1; //type (0:PTP 1:LINE 2:CIRCLE 100:user defined 200:end row)
28 HD[173] = 0; //parameters
29 DFHD[176] = 200000; //target position X
30 DFHD[180] = 150000; //target position Y
31 DFHD[184] = 0; //target position Z
32 DFHD[224] = 20000; //target speed
33
34 HD[230] = 3; //row number 3
35 HD[232] = 200; //type (0:PTP 1:LINE 2:CIRCLE 100:user defined 200:end row)
36 HD[233] = 0; //parameters
```

After setting the parameters, trigger the command G_PATHSEL to load 3 rows of data.

Multiple loading:

```
9 void FUNC1( WORD W , BIT B )
10 {
11 #define SysRegAddr_HD_D_HM_M
12 #define DFHD *(FP64*)&HD //DFHD represents double precision floating-point HD register
13
14 //set value for G_PATHSEL
15 HD[100] = 1;//data row numbers
16 HD[101] = 0;//0: continue insert 1:reload
17
18 HD[110] = 1;//row number 1
19 HD[112] = 1;//type (0:PTP 1:LINE 2:CIRCLE 100:user defined 200:end row)
20 HD[113] = 0;//parameter
21 DFHD[116] = 100000;//target position X
22 DFHD[120] = 100000;//target position Y
23 DFHD[124] = 0;//target position Z
24 DFHD[164] = 20000;//target speed
```

Set the data row to 1, execute command G_PATHSEL to load one point, then modify the command parameters.

```
9 void FUNC1( WORD W , BIT B )
10 {
11 #define SysRegAddr_HD_D_HM_M
12 #define DFHD *(FP64*)&HD //DFHD represents double precision floating-point HD register
13
14 //set value for G_PATHSEL
15 HD[100] = 2;//data row numbers
16 HD[101] = 0;//0: continue insert 1:reload
17
18 HD[110] = 2;//row number 2
19 HD[112] = 1;//type (0:PTP 1:LINE 2:CIRCLE 100:user defined 200:end row)
20 HD[113] = 0;//parameter
21 DFHD[116] = 200000;//target position X
22 DFHD[120] = 150000;//target position Y
23 DFHD[124] = 0;//target position Z
24 DFHD[164] = 20000;//target speed
25
26 HD[170] = 3;//row number 3
27 HD[172] = 200;//type (0:PTP 1:LINE 2:CIRCLE 100:user defined 200:end row)
28 HD[173] = 0;//parameters
```

The data row numbers are 2, the row number starts from 2 (larger than the first row number), trigger the command G_PATHSEL again to load two points, that is, 3 rows of data are loaded.

5-2-2-14. Path motion 【G_PATHMOV】

(1) Overview

The axis group will move as the path specified by G_PATHSEL.

Path motion [G_PATHMOV]			
Execution condition	Rising/falling edge of the coil	Suitable model	XDH, XLH
Firmware	V3.6.1b and above	Software	V3.7.4 and above

(2) Operand

Operand	Function	Type
S0	Specify the input parameter start address	16-bit, single word
S1	Specify the output state word start address	16-bit, single word
S2	Specify the output position start address	32-bit, double words
S3	Specify the output state bit start address	Bit
S4	Specify the axis group number	16-bit, single word

(3) Suitable soft component

Operand	Word soft component										Bit soft component						
	System								Constant K/H	Module ID QD		System					
	D*	FD	TD*	CD*	DX	DY	DM*	DS*				X	Y	M*	S*	T*	C*
S0	●	●	●	●	●	●	●	●									
S1	●	●	●	●	●	●	●	●									
S2	●	●	●	●	●	●	●	●									
S3														●			
S4	●								●								

*: D means D, HD; TD means TD and HTD; CD means CD, HCD, HSCD and HSD; DM means DM and DHM; DS means DS and DHS; M means M, HM, SM; S means S, HS; T means T, HT; C means C, HC.

(4) Function and action



- S0 specifies the input parameter start address, occupies the register S0~S0+1
- S1 specifies the output state word start address
- S2 specifies the output position start address, occupies the register S2~S2+79
- S3 specifies the output state bit start address, occupies the relay S3~S3+4
- S4 specifies the axis group number
- When M0 is from OFF→ON, it will move as the path specified by G_PATHSEL
- After executing the command, the single axis state of axis group (D20000+200*N) is 8, the axis group state (D46000+300*N) is 2

(5) Related parameters

Input parameter	Parameter name	Data type	Unit	Note
S0	Coordinatesystemm	INT16U	-	Coordinate system. Not supported at the moment
S0+1	BufferMode	INT16U	-	Buffer mode 0: interrupt mode 1: buffer mode
Output parameter	Parameter name	Data type	Unit	Note
S1	ErrCode	INT16U	-	Command error code
Position output	Parameter name	Data type	Unit	Note
S2	Row 1	INT32U	-	Row 1

S2+2	PositionX	FP32	Command unit	History location X1
S2+4	PositionY	FP32	Command unit	History location Y1
S2+6	PositionZ	FP32	Command unit	History location Z1
Position output	Parameter name	Data type	Unit	Note
S2+8	PositionA	FP32	Command unit	History location A1
S2+10	PositionB	FP32	Command unit	History location B1
S2+12	PositionC	FP32	Command unit	History location C1
.....				
S2+126	Row 2	INT32U	-	Row 10
S2+128	PositionX	FP32	Command unit	History location X10
S2+130	PositionY	FP32	Command unit	History location Y10
S2+132	PositionZ	FP32	Command unit	History location Z10
S2+134	PositionA	FP32	Command unit	History location A10
S2+136	PositionB	FP32	Command unit	History location B10
S2+138	PositionC	FP32	Command unit	History location C10
S2+140	Next running row 11	INT32U	-	Row 11
S2+142	X11	FP32	Command unit	Ready to run position X11
S2+144	Y11	FP32	Command unit	Ready to run position Y11
S2+146	Z11	FP32	Command unit	Ready to run position Z11
S2+148	A11	FP32	Command unit	Ready to run position A11
S2+150	B11	FP32	Command unit	Ready to run position B11
S2+152	C11	FP32	Command unit	Ready to run position C11
S2+154	M code 1	INT16U	-	9999: no M code
S2+155	M code 2	INT16U	-	1000-1999: non-stop M code
S2+156	M code 3	INT16U	-	Others are stop M code
S2+157	M code 4	INT16U	-	
S2+158	M code 5	INT16U	-	
S2+159	M code 6	INT16U	-	
S2+160	M code 7	INT16U	-	
S2+161	M code 8	INT16U	-	
S2+162	M code 9	INT16U	-	
State parameter	Parameter name	Data type	Unit	Note
S3	Done	BOOL	-	Instruction execution completed
S3+1	Busy	BOOL	-	The instruction is being executed
S3+2	Active	BOOL	-	The instruction is under control
S3+3	Abort	BOOL	-	Instruction is interrupted
S3+4	Error	BOOL	-	Instruction execution error
Axis number	Parameter name	Data type	Unit	Note
S4	Axis	INT16U	-	Axis group number starts from 0

- The output position data will record the points that have been executed. The point recording starts from the historical record position 10. When there is a new point recording, the historical point will be moved up, that is, after executing G_PATHSEL, the point of row number 1 in pathsel instruction is recorded in S2 + 72 ~ S2 + 78. After executing the point of row number 2, move the originally recorded point to S2 + 64 ~ S2 + 70, and write the new point to S2 + 72 ~ S2 + 78, and so on.
- G_PATHMOV can be paused by command G_INTR, but it cannot continue moving through the command G_GOON. Execute the command G_PATHMOV again to continue the original motion (other axis group commands can be executed in the pause process).
- G_PATHMOV is different from other motion commands, the command is affected by forward-looking parameters, and the connection between curves is smoother.

- For the data to be run, the interface only displays one row of data, but it will actually occupy more registers later. The instruction output parameters need about 440 registers in total. Please avoid them during planning to prevent data conflict.

(6) Sequence diagram

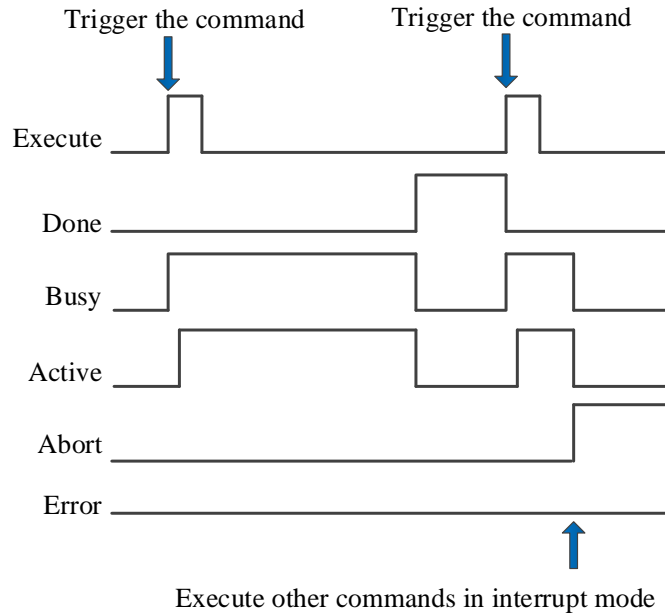

Explanation:

Generally, after the command is triggered, the Busy and Active signals are set, and reset after the command is completed. At the same time, the Done signal is set. Done will reset only after the command is triggered again, otherwise it will not reset automatically.

When the instruction is triggered in the buffer mode and there are currently instructions being executed, the Active signal will be set immediately. The execution of the current instruction ends. When the instruction is executed, the Busy signal will be set. After the execution of the instruction ends, the Busy and Active signals will be reset and the Done signal will be set.

When a new instruction is triggered in interrupt mode during instruction execution, the Busy and Active signals are reset immediately and the Abort signal is set.

When there is an error in the command, the Error signal is set, other signals are reset, and the corresponding error code is output.

(7) Application

- ① make the ladder diagram

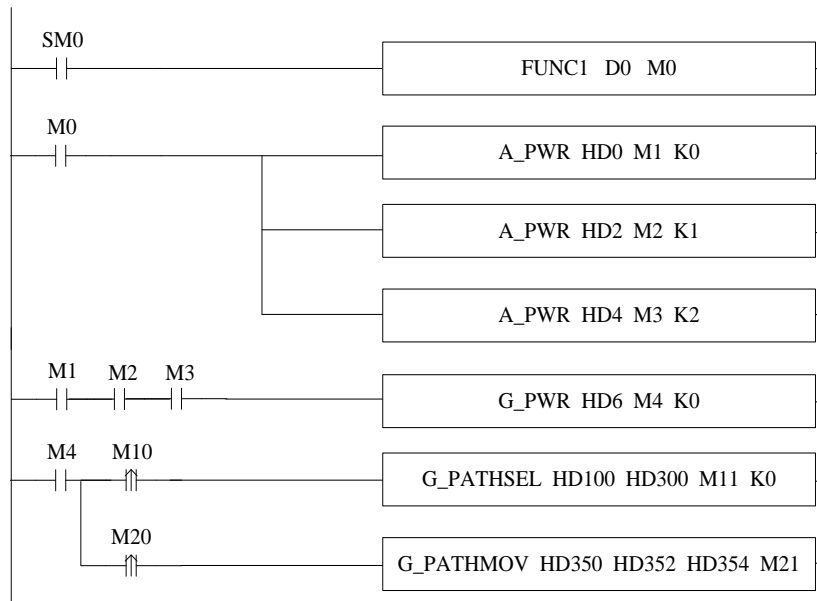

FUNC1 is used to set the value for the command G_PATHSEL, M0 turns on each axis enable, when the three axes are enabled (M1, M2, M3 are ON, turns on the axis group enable. After the axis group enabled (M4 is ON). When M10 is ON, the command G_PATHSEL is executed. When command completion flag M11 is ON, set ON M20 to trigger the command G_PATHMOV.

② set the value for G_PATHSEL (right click the command to set the value, or set the value through C program):

```

9 void FUNC1( WORD W , BIT B )
10 {
11 #define SysRegAddr_HD_D_HM_M
12 #define DFHD *(FP64*)&HD //DFHD represents double precision floating-point HD register
13
14 //set value for G_PATHSEL
15 HD[100] = 3;//data row numbers
16 HD[101] = 0;//0: continue insert 1:reload
17
18 HD[110] = 1;//row number 1
19 HD[112] = 1;//type (0:PTP 1:LINE 2:CIRCLE 100:user defined 200:end row)
20 HD[113] = 0;//parameter
21 DFHD[116] = 100000;//target position X
22 DFHD[120] = 100000;//target position Y
23 DFHD[124] = 0;//target position Z
24 DFHD[164] = 20000;//target speed
25
26
27 HD[170] = 2;//row number 2
28 HD[172] = 1;//type (0:PTP 1:LINE 2:CIRCLE 100:user defined 200:end row)
29 HD[173] = 0;//parameters
30 DFHD[176] = 200000;//target position X
31 DFHD[180] = 150000;//target position Y
32 DFHD[184] = 0;//target position Z
33 DFHD[224] = 20000;//target speed
34
35 HD[230] = 3;//row number 3
36 HD[232] = 200;//type (0:PTP 1:LINE 2:CIRCLE 100:user defined 200:end row)
37 HD[233] = 0;//parameters
--

```

The instruction demonstrated in this example is the path planning movement of XY axis (the axis group type only supports XYZ type, and the axis group of XY axis can be realized by setting the corresponding axis configuration of Z axis as virtual axis). The planning path is two lines, and the movement amount of each turn of X and Y axes is 10000. Assign values to the parameters as shown in the figure and trigger G_PATHSEL command can insert into the point, the first point is (100000,100000), the second point is (200000, 150000), and the running speed of the axis group is 20000 command unit/s.

③ The operation track of the axis group is shown in the figure below (where the x-axis position is the abscissa and the y-axis position is the ordinate):

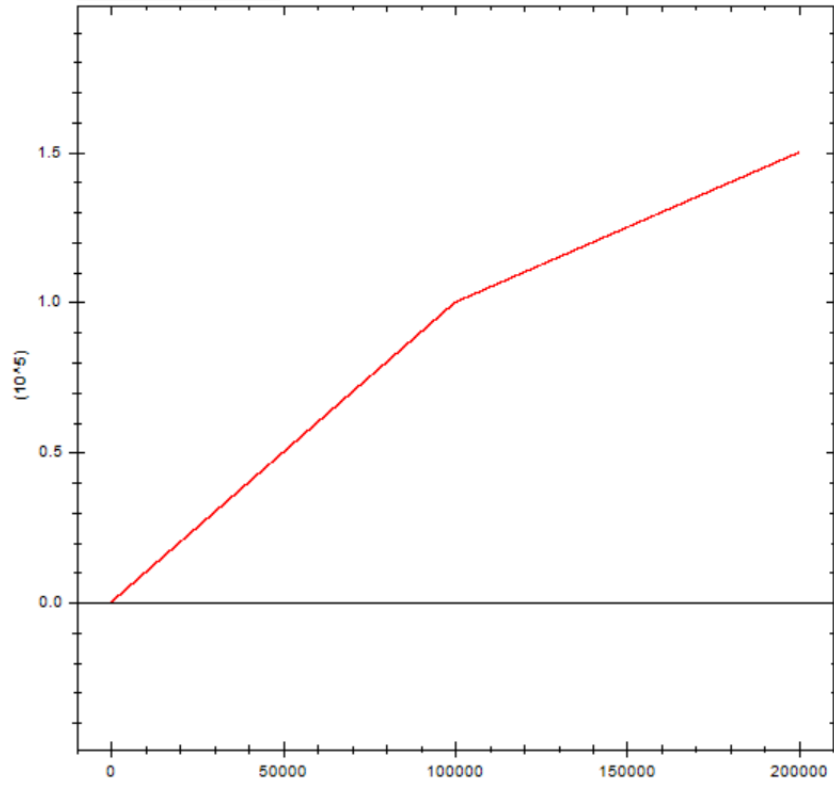

5-2-2-15. Modify the multiplying power 【G_SETOVRD】

(1) Overview

Modify the multiplying power of the parameters.

Modify the multiplying power [G_SETOVRD]			
Execution condition	Rising/falling edge of the coil	Suitable model	XDH, XLH
Firmware	V3.6.1b and above	Software	V3.7.4 and above

(2) Operand

Operand	Function	Type
S0	Specify the input parameter start address	64-bit, four words
S1	Specify the output state word start address	16-bit, single word
S2	Specify the output state bit start address	Bit
S3	Specify the axis group number	16-bit, single word

(3) Suitable soft component

Operand	Word soft component										Bit soft component						
	System								Constant K/H	Module		System					
	D*	FD	TD*	CD*	DX	DY	DM*	DS*		ID	QD	X	Y	M*	S*	T*	C*
S0	●	●	●	●	●	●	●	●									
S1	●	●	●	●	●	●	●	●									
S2														●			
S3	●								●								

*: D means D, HD; TD means TD and HTD; CD means CD, HCD, HSCD and HSD; DM means DM and DHM; DS means DS and DHS; M means M, HM, SM; S means S, HS; T means T, HT; C means C, HC.

(4) Function and action



- S0 specifies the input parameter start address, occupies the register S0~S0+11
- S1 specifies the output state word start address
- S2 specifies the output state bit start address, occupies the relay S2~S2+3
- S3 specifies the axis group number
- When M0 is from OFF→ON, the axis group specified by S3 will modify the multiplying power of speed, acceleration, jerk speed as user setting
- When the speed ratio exceeds 200%, the system takes effect according to the maximum 200%
- It only takes effect in the motion process of G_PATHMOV

(5) Related parameters

Input parameter	Parameter name	Data type	Unit	Note
S0	VelFactor	FP64	%	The target speed multiplier cannot be less than 1%. When the set value is less than 1%, it will be treated as 1% (excluding 0. If the speed multiplier is set to 0, an error code will be returned)
S0+4	AccFactor	FP64	-	Target acceleration magnification (not supported temporarily)
S0+8	JerkFactor	FP64	-	Target jerk speed magnification (not supported temporarily)
Output parameter	Parameter name	Data type	Unit	Note
S1	ErrCode	INT16U	-	Command error code
State parameter	Parameter name	Data type	Unit	Note

S2	Done	BOOL	-	Instruction execution is completed
S2+1	Busy	BOOL	-	Instruction is being executed
S2+2	Abort	BOOL	-	Instruction is interrupted
S2+3	Error	BOOL	-	Instruction execution error
Axis number	Parameter name	Data type	Unit	Note
S3	Axis	INT16U	-	Axis group number starts from 0

(6) Sequence diagram

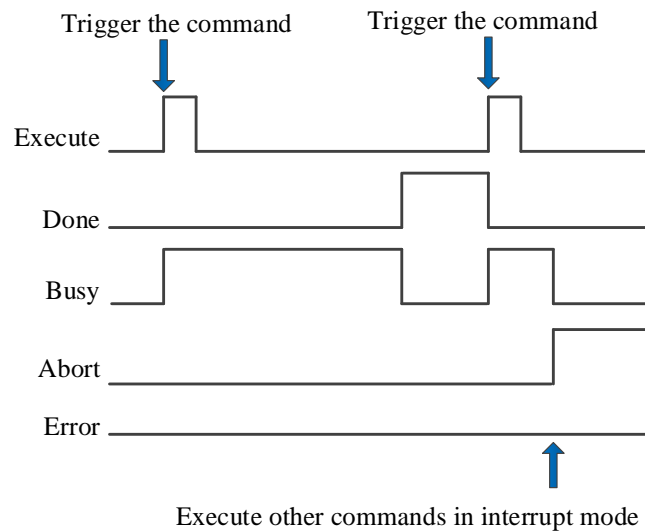

Explanation:

Generally, after the command is triggered, the Busy signal is set, reset after the command is completed, and the Done signal is set. Done is reset only after the command is triggered again, otherwise it will not be reset automatically.

When the instruction is interrupted or has an error, the corresponding Abort or Error signal is set, other signals are reset, and the corresponding error code will be output in case of error.

(7) Application

The running speed of G_PATHMOV instruction becomes one tenth of the original speed, and the ladder diagram is as follows:

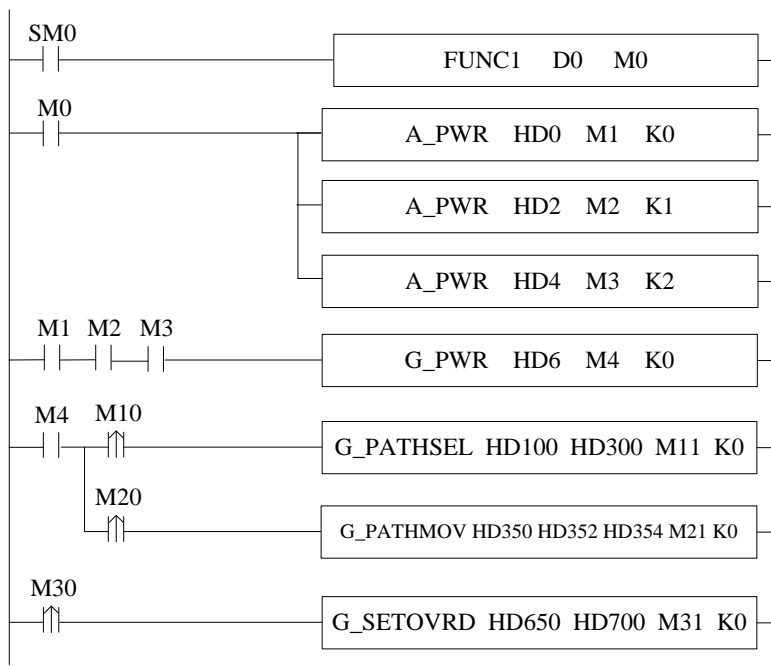

G_SETOVRDInstruction parameter configuration

Input parameter: Output parameter: Status parameter:

Effective shaft group no:

Name	Addr	Online value	Offline value	Data type	statement
Input parameter					
VelFactor	HD650	0	10	FP64	The speed ratio
AccFactor	HD654	0	0	FP64	Acceleration ratio
JerkFactor	HD658	0	0	FP64	Plus the acceleration
Output parameter					
ErrCode	HD700	0		INT16U	Error code
Status parameter					
Done	M31	False		BIT	Completion status
Busy	M32	False		BIT	busy
Abort	M33	False		BIT	Interrupt status
Err	M34	False		BIT	Error status

space usage : ID650-HD661,HD700-HD700,M31-M34,

Explanation:

The running speed of G_PATHMOV is changed to one tenth of the original speed, that is, the speed magnification is 10%. In this example, G_PATHSEL and G_PATHMOV instruction configurations is the same as G_PATHMOV application example, refer to chapter 5-2-2-8. When G_PATHMOV is in normal operation, the axis group speed can be changed through G_SETOVRD. The speed parameter of the axis group is $D46116+300*N$. (Note: the modified magnification is based on the target speed of G_PATHMOV, that is, the speed of the current operating section of G_PATHMOV is 20000, the speed magnification is 10%, and the speed of the axis group becomes 2000 after the command is triggered).

The speed curve of axis group:

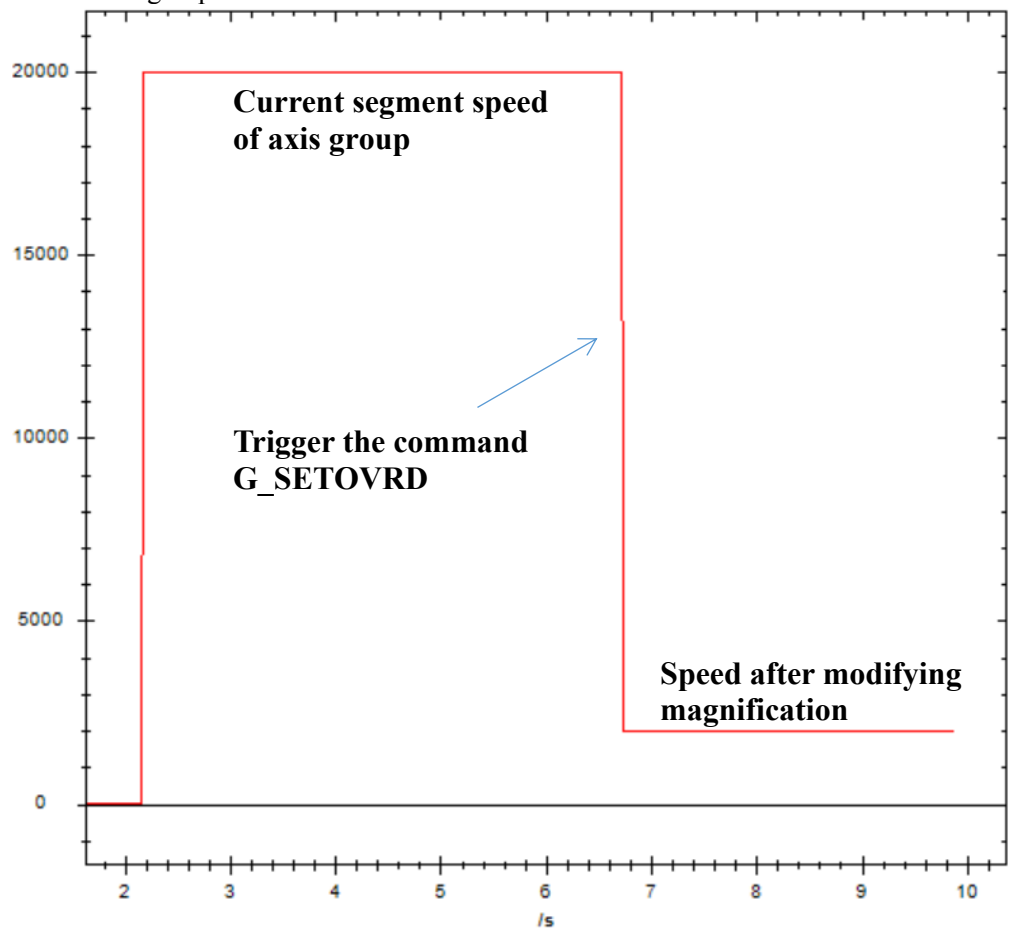

5-2-3. Related coil and register

After the relevant register is modified, it will take effect after power on again.

System parameters

Address	Definition	Data type	Initial value	Note
SFD811	Motion control function activation mode	INT16U	0	0: C motion * 1: H motion
SFD820	Axis group numbers	INT32U	0	Set the axis group number as needs, at present, the maximum number of axis groups supported is 2
SFD824	Axis group bit state start address	INT32U	28000	Axis group related coil start address
SFD826	Axis group word state start address	INT32U	46000	Axis group related register start address

*Note:

C motion does not support all commands and parameters in this manual. Please refer to EtherCAT motion control user manual for specific usage.

Axis configuration parameter (N is axis group number)

Basic parameters

Address	Definition	Data type	Unit	Initial value	Note
SFD48000+300*N	Kinematic type	INT16U	-	1	0: XY (not support) 1: XYZ
SFD48001+300*N	Set axis number 1	INT16U	-	0	axis X number of the axis group
SFD48002+300*N	Set axis number 2	INT16U	-	1	axis Y number of the axis group
SFD48003+300*N	Set axis number 3	INT16U	-	2	axis Z number of the axis group
SFD48004+300*N	Set axis number 4	INT16U	-	65535	axis A number of the axis group
SFD48005+300*N	Set axis number 5	INT16U	-	65535	axis B number of the axis group
SFD48006+300*N	Set axis number 6	INT16U	-	65535	axis C number of the axis group
SFD48007+300*N	Axis group error stop method	INT16U	-	0	0: deceleration stop 1: emergency stop
SFD48008+300*N	Emergency stop mode	INT16U	-	0	0: given stop 1: feedback stop. When the speed is high, the use of feedback stop may lead to servo alarm

Performance parameters

Address	Definition	Data type	Unit	Initial value	Note
SFD48020+300*N	XYZ max speed	FP64	Command unit/s	6553600	If the speed parameter in the command is higher than the maximum speed, it will run at the maximum speed
SFD48024+300*N	XYZ max acceleration	FP64	Command unit/s ²	65536000	If the acceleration parameter in the command is higher than the maximum acceleration, it will run at the maximum acceleration
SFD48028+300*N	XYZ max deceleration	FP64	Command unit/s ²	65536000	If the deceleration parameter in the command is higher than the maximum deceleration, it will run at the maximum deceleration
SFD48032+300*N	XYZ max jerk speed	FP64	Command unit/s ³	655360000	If the jerk speed parameter in the command is higher than the maximum jerk

Address	Definition	Data type	Unit	Initial value	Note
					speed, it will run at the maximum jerk speed
SFD48036+300*N	ABC max speed	FP64	Command unit/s	6553600	If the speed parameter in the command is higher than the maximum speed, it will run at the maximum speed
SFD48040+300*N	ABC max acceleration	FP64	Command unit/s ²	65536000	If the acceleration parameter in the command is higher than the maximum acceleration, it will run at the maximum acceleration
SFD48044+300*N	ABC max deceleration	FP64	Command unit/s ²	65536000	If the deceleration parameter in the command is higher than the maximum deceleration, it will run at the maximum deceleration
SFD48048+300*N	ABC max jerk speed	FP64	Command unit/s ³	655360000	If the jerk speed parameter in the command is higher than the maximum jerk speed, it will run at the maximum jerk speed
SFD48052+300*N	XYZ default speed percentage	INT16U	-	10	When the speed in the command is set to 0, it is executed with the highest acceleration * default acceleration percentage
SFD48053+300*N	XYZ default acceleration percentage	INT16U	-	10	When the acceleration in the command is set to 0, it is executed as the highest acceleration * default acceleration percentage
SFD48054+300*N	XYZ default deceleration percentage	INT16U	-	10	When the deceleration in the command is set to 0, the maximum deceleration * default deceleration percentage is executed
SFD48055+300*N	XYZ default jerk speed percentage	INT16U	-	10	When the jerk speed in the command is set to 0, it is executed as the highest jerk speed * default jerk speed percentage
SFD48056+300*N	ABC default speed percentage	INT16U	-	10	When the speed in the command is set to 0, it is executed with the highest acceleration * default acceleration percentage
SFD48057+300*N	ABC default acceleration percentage	INT16U	-	10	When the acceleration in the command is set to 0, it is executed as the highest acceleration * default acceleration percentage
SFD48058+300*N	ABC default deceleration percentage	INT16U	-	10	When the deceleration in the command is set to 0, the maximum deceleration * default deceleration percentage is executed
SFD48059+300*N	ABC default jerk	INT16U	-	10	When the jerk speed in the

Address	Definition	Data type	Unit	Initial value	Note
	speed percentage				command is set to 0, it is executed as the highest jerk speed * default jerk speed percentage

Alarm parameters

Address	Definition	Data type	Unit	Initial value	Note
SFD48100+300*N	XYZ speed alarm percentage	INT16U		100	When XYZ axis group linear speed is over the alarm value, the axis group will alarm
SFD48101+300*N	XYZ acceleration alarm percentage	INT16U		100	Not supported at the moment
SFD48102+300*N	XYZ deceleration alarm percentage	INT16U		100	Not supported at the moment
SFD48103+300*N	ABC speed alarm percentage	INT16U		100	When ABC axis group linear speed is over the alarm value, the axis group will alarm
SFD48104+300*N	ABC acceleration alarm percentage	INT16U	-	100	Not supported at the moment
SFD48105+300*N	ABC deceleration alarm percentage	INT16U	-	100	Not supported at the moment

Limit configuration parameters

Address	Definition	Data type	Unit	Initial value	Note
SFD48120+300*N	X axis max soft limit	FP64	Command unit	1000000000	
SFD48124+300*N	Y axis max soft limit	FP64	Command unit	1000000000	
SFD48128+300*N	Z axis max soft limit	FP64	Command unit	1000000000	
SFD48132+300*N	X axis min soft limit	FP64	Command unit	-1000000000	
SFD48136+300*N	Y axis min soft limit	FP64	Command unit	-1000000000	
SFD48140+300*N	Z axis min soft limit	FP64	Command unit	-1000000000	
SFD48144+300*N	Start the soft limit	INT16U	-	0	0: not enable 1: enable
SFD48155+300*N	Soft limit stop type	INT16U	-	0	0: slow stop 1: emergency stop

Forward-looking parameters

(The smoothness of the motion curve affected by the forward-looking parameters which should not be easily modified. Please consult the technician if necessary)

Address	Definition	Data type	Unit	Initial value	Note
SFD48240+300*N	Forward looking corner acceleration	FP64	Command unit/s ²	10000	
SFD48244+300*N	Centrifugal acceleration	FP64	Command unit /s ²	125	
SFD48248+300*N	Maximum handwheel speed	FP64	Command unit /s	50	
SFD48252+300*N	Maximum handwheel acceleration	FP64	Command unit /s ²	500	

Address	Definition	Data type	Unit	Initial value	Note
SFD48256+300*N	Forward looking straight line transition error	FP64	Command unit	0.005	
SFD48260+300*N	Forward looking arch height error	FP64	Command unit	0.0025	
SFD48264+300*N	Arc transition error limit	FP64	Command unit	0.005	
SFD48269+300*N	G00 change to G01	INT16U	-	0	
SFD48270+300*N	Emergency stop mode	INT16U	-	0	
SFD48271+300*N	Stop time ratio	INT16U	-	10	
SFD48272+300*N	Stop mode	INT16U	-	0	
SFD48273+300*N	Z-axis feed rate of handwheel	INT16U	-	100	
SFD48274+300*N	Minimum included angle limit of forward-looking section	INT16U	-	60	
SFD48275+300*N	Forward looking transition angle limit	INT16U	-	160	
SFD48276+300*N	Handwheel high speed counting port	INT16U	-	0	
SFD48277+300*N	Handwheel filtering cycles	INT16U	-	50	
SFD48278+300*N	Use default feed rate	INT16U	-	0	
SFD48280+300*N	Handwheel pulse equivalent	INT32U	-	100	

Axis group state coil (the coil start address is decided by SFD824)

Address	Definition	Note
M28000+100*N	Axis group enable	ON: axis group enable state
M28001+100*N	Axis group motion	ON: axis group motion state
M28003+100*N	Axis group error	ON: axis group error state
M28004+100*N	Axis group buffer state	ON: the axis group commands are saved in the buffer
M28010+100*N	MST interactive	ON: G PATHMOV moves to the user defined operation row specified by G PATHSEL

Axis group state register (the register start address is decided by SFD826)

Address	Definition	Data type	Unit	Note
D46000+300*N	axis group state machine	INT16U	-	0: the axis group is not enabled 1: axis group enabled, not moving 2: Axis group in motion 3: axis group stop 4: Axis group error
D46001+300*N	Axis group error code	INT16U	-	Display the axis group error code
D46020+300*N	Current motion segment end point X	FP64	Command unit	X axis current motion end position
D46024+300*N	Current motion segment end point Y	FP64	Command unit	Y axis current motion end position
D46028+300*N	Current motion segment end point Z	FP64	Command unit	Z axis current motion end position
D46032+300*N	Current motion segment end point A	FP64	Command unit	A axis current motion end position
D46036+300*N	Current motion segment end point B	FP64	Command unit	B axis current motion end position
D46040+300*N	Current motion segment end point C	FP64	Command unit	C axis current motion end position
D46044+300*N	Current motion given position X	FP64	Command unit	X axis current motion give position
D46048+300*N	Current motion given position Y	FP64	Command unit	Y axis current motion give position

Address	Definition	Data type	Unit	Note
D46052+300*N	Current motion given position Z	FP64	Command unit	Z axis current motion give position
D46056+300*N	Current motion given position A	FP64	Command unit	A axis current motion give position
D46060+300*N	Current motion given position B	FP64	Command unit	B axis current motion give position
D46064+300*N	Current motion given position C	FP64	Command unit	C axis current motion give position
D46068+300*N	Current motion given joint speed X	FP64	Command unit	X axis current motion given speed
D46072+300*N	Current motion given joint speed Y	FP64	Command unit	Y axis current motion given speed
D46076+300*N	Current motion given joint speed Z	FP64	Command unit	Z axis current motion given speed
D46080+300*N	Current motion given joint speed A	FP64	Command unit	A axis current motion given speed
D46084+300*N	Current motion given joint speed B	FP64	Command unit	B axis current motion given speed
D46088+300*N	Current motion given joint speed C	FP64	Command unit	C axis current motion given speed
D46092+300*N	Current motion given flange position X	FP64	Command unit	X axis current motion given flange position
D46096+300*N	Current motion given flange position Y	FP64	Command unit	Y axis current motion given flange position
D46100+300*N	Current motion given flange position Z	FP64	Command unit	Z axis current motion given flange position
D46104+300*N	Current motion given flange position A	FP64	Command unit	A axis current motion given flange position
D46108+300*N	Current motion given flange position B	FP64	Command unit	B axis current motion given flange position
D46112+300*N	Current motion given flange position C	FP64	Command unit	C axis current motion given flange position
D46116+300*N	Current motion linear speed	FP64	Command unit	Composite speed of axis group
D46140+300*N	Current motion feedback position X	FP64	Command unit	X axis current motion feedback position
D46144+300*N	Current motion feedback position Y	FP64	Command unit	Y axis current motion feedback position
D46148+300*N	Current motion feedback position Z	FP64	Command unit	Z axis current motion feedback position
D46152+300*N	Current motion feedback position A	FP64	Command unit	A axis current motion feedback position
D46156+300*N	Current motion feedback position B	FP64	Command unit	B axis current motion feedback position
D46160+300*N	Current motion feedback position C	FP64	Command unit	C axis current motion feedback position
D46226+300*N	PATHSEL buffer remaining space	INT32S		PATHSEL buffer remaining space
D46249+300*N	M code	INT16U		PATHMOV mapping
D46262+300*N	PATHMOV row number	INT16U		PATHMOV row number

5-3. Cam function

Electronic cam is a software system that uses the constructed cam curve to simulate the mechanical cam, so as to achieve the relative movement between the camshaft and the main shaft of the same mechanical cam system. In machining, electronic cams are used to replace heavy mechanical cams. The system using electronic cam has higher machining accuracy and flexibility and improves production efficiency.

As for the command positions of the main shaft and the slave shaft, the two cams data are interpolated in a straight line mode(the mode can be changed) to obtain the displacement(slave shaft) equivalent to the phase (main shaft). When there are few cam points, the accuracy is low, but the amount of data is small. The more points, the smaller the phase interval and the higher the accuracy.

5-3-1. Command list

Command	Function	Chapter
CAMTBLSEL	Cam table loading	5-3-2-1
CAMIN	Cam start	5-3-2-2
CAMOUT	Cam release	5-3-2-3
CAMPHASE	Phase compensation	5-3-2-4
CAMRD	Read cam table	5-3-2-5
CAMWR	Write cam table	5-3-2-6
CAMPOINTADD	Add key point	5-3-2-7
CAMPOINTDEL	Delete key point	5-3-2-8
CAMTBLDEL	Cam table unloading	5-3-2-9

5-3-2. Command introduction

5-3-2-1. Cam table loading 【CAMTBLSEL】

(1) Overview

Load the set cam table and generate an example of the cam table.

Cam table loading [CAMTBLSEL]			
Execution condition	Rising/falling edge of the coil	Suitable model	XDH, XLH
Firmware	V3.6.1b and above	Software	V3.7.4 and above

Note: XDH, XLH series -L models cannot support this instruction.

(2) Operand

Operand	Function	Type
S0	Specify the input parameter start address	16-bit, single word
S1	Specify the output state word start address	16-bit, single word
S2	Specify the output state bit start address	Bit

(3) Suitable soft component

Operand	Word soft component								Bit soft component									
	System								Constant	Module	System							
	D*	FD	TD*	CD*	DX	DY	DM*	DS*	K/H	ID	QD	X	Y	M*	S*	T*	C*	
S0	●	●	●	●	●	●	●	●										
S1	●	●	●	●	●	●	●	●										
S2														●				

*: D means D, HD; TD means TD and HTD; CD means CD, HCD, HSCD and HSD; DM means DM and DHM; DS means DS and DHS; M means M, HM, SM; S means S, HS; T means T, HT; C means C, HC.

(4) Function and action



- S0 specifies the input parameters start address, occupies the register S0~S0+3
- S1 specifies the output parameters start address, occupies the register S1~S1+1
- S2 specifies the output state bit start address, occupies the register S2~S2+2
- When M0 is from OFF→ON, load the cam table according to the set cam table number. After successful loading, a cam table instance will be generated and stored in the corresponding register of S1.

(5) Notes

- Before using the command CAMIN and CAMRD, it needs to get the cam table instance through the CAMTBLSEL, which is the output parameter
- The loaded cam table instance fails after the PLC stops and power is off. It needs to be loaded again after the next power on
- The CAMTBLSEL command can be executed multiple times for the same cam table number, and the generated cam table instances will be valid and irrelevant to each other. The maximum number of cam table instances shall not exceed 32, and the total number of points inside all cam table instances shall not exceed 65536. When the loaded cam table instance is not needed, it is unloaded through CAMTBLDEL command

(6) Related parameters

Input parameter	Parameter name	Data type	Unit	Note
S0	Camtbl	INT16S	-	Cam table number. which is the CamProfile ID on the cam configuration interface
S0+1	Periodic	INT16S	-	Loop execution

Input parameter	Parameter name	Data type	Unit	Note
				0: OFF 1: ON
S0+2	MasterAbs	INT16S	-	Main axis mode 0: relative 1: absolute
S0+3	SlaverAbs	INT16S	-	Slave axis mode 0: relative 1: absolute
Output parameter	Parameter name	Data type	Unit	Note
S1	CamtblID	INT16S	-	Cam table instance. One of the input variables of other cam table commands
S1+1	ErrCode	INT16S	-	Command error code
Output state	Parameter name	Data type	Unit	Note
S2	Done	BOOL	-	The command execution completed
S2+1	Busy	BOOL	-	The command is being executed
S2+2	Error	BOOL	-	The command execution is error

- The main axis adopts relative / absolute mode, which affects the initial position of internal latch when CAMIN command is triggered, and only the attributes of the cam table are given when CAMTBLSEL is triggered. The final mode of the main axis is only determined by the MasterAbs and is not affected by the StartMode in the CAMIN command. It should be noted that the main axis absolute mode may cause a step from the slave axis position.
- The slave axis adopts relative / absolute mode, which affects the initial position of internal latch when CAMIN command is triggered, and only the attributes of the cam table are given when CAMTBLSEL is triggered. The final mode of the slave axis is affected by the StartMode in the CAMIN command. It should be noted that the slave axis absolute mode may cause a step from the slave axis position.
- Cam table instance is one of the input parameters of other cam commands. It is randomly generated by CAMTBLSEL command and has nothing to do with the cam ID of cam configuration interface. The same cam table can be loaded multiple times. The generated cam table instances are different and do not affect each other.

(7) Sequence diagram

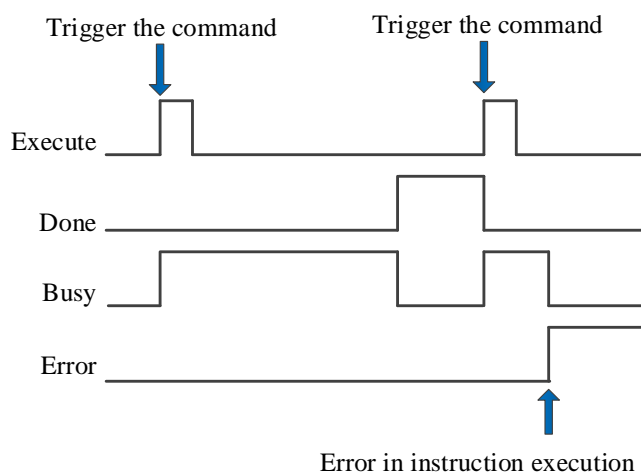

Explanation:

The command is triggered and the Busy signal is set. When the command execution is completed, the Busy signal is reset and the Done signal is set.

When there is an error during instruction execution, the Error signal is set, other signals are reset, and the corresponding error code is output.

5-3-2-2. CAM start 【CAMIN】

(1) Overview

Perform cam movement according to the set parameters according to the loaded cam table.

CAM start [CAMIN]			
Execution condition	Rising/falling edge of the coil	Suitable model	XDH, XLH
Firmware	V3.6.1b and above	Software	V3.7.4 and above

Note: XDH, XLH series -L models cannot support this instruction.

(2) Operand

Operand	Function	Type
S0	Specify the input parameter start address	16-bit, single word
S1	Specify the output state word start address	16-bit, single word
S2	Specify the output state bit start address	Bit

(3) Suitable soft component

Operand	Word soft component										Bit soft component						
	System								Constant K/H	Module		System					
	D*	FD	TD*	CD*	DX	DY	DM*	DS*		ID	QD	X	Y	M*	S*	T*	C*
S0	●	●	●	●	●	●	●	●									
S1	●	●	●	●	●	●	●	●									
S2														●			

*: D means D, HD; TD means TD and HTD; CD means CD, HCD, HSCD and HSD; DM means DM and DHM; DS means DS and DHS; M means M, HM, SM; S means S, HS; T means T, HT; C means C, HC.

(4) Function and action



- S0 specifies the input parameters start address, occupies the register S0~S0+47
- S1 specifies the output parameters start address, occupies the register S1~S1+1
- S2 specifies the output state bit start address, occupies the register S2~S2+5
- When M0 is from OFF→ON, execute the CAM motion as the input parameters

(5) Related parameters

Input parameter	Parameter name	Data type	Unit	Note
S0	Master	INT16S	-	Main axis number starts from 0
S0+1	Slaver	INT16S	-	Slave axis number starts from 0
S0+2	CamtblID	INT16S	-	CAM table instance is generated by CAMTBLSEL
S0+3	StartMode	INT16S	-	Start mode of main and slave axis 0: relative mode 1: absolute mode 2: tracking mode
S0+4	MasterSource	INT16S	-	main axis data source type 0: main axis current position given 1: main axis last position given 2: main axis current position feedback 3: main axis last position feedback
S0+5	BufferMode	INT16S	-	Buffer mode 0: interrupt mode 1: buffer mode
S0+6	Dir	INT16S	-	Synchronous direction 0: both forward and reverse synchronization

Input parameter	Parameter name	Data type	Unit	Note
				1: Forward synchronization only. Not supported at the moment 2: Reverse synchronization only. Not supported at the moment
S0+8	MasterOffset	FP64	-	Main axis offset
S0+12	SlaverOffset	FP64	-	Slave axis offset
S0+16	MasterScaling	FP64	-	Main axis ratio
S0+20	SlaverScaling	FP64	-	Slave axis ratio
S0+32	VecDiff	FP64	Command unit/s	Max tracking speed in tracking mode
S0+36	Acc	FP64	Command unit /s ²	Tracking acceleration in tracking mode
S0+40	Dec	FP64	Command unit /s ²	Tracking deceleration in tracking mode
S0+44	Jerk	FP64	Command unit /s ³	Tracking jerk speed in tracking mode. Jerk speed is the acceleration/deceleration change rate
Output parameter	Parameter name	Data type	Unit	Note
S1	Index	INT16S	-	Current executed cam table segment number, the segment number is the point number which is going to
S1+1	ErrCode	INT16S	-	Command error code
Output state	Parameter name	Data type	Unit	Note
S2	InSync	BOOL	-	Establishment of cam relationship between master and slave axis
S2+1	Busy	BOOL	-	The command is being executed
S2+2	Active	BOOL	-	The command is under control (affected by buffer mode)
S2+3	Abort	BOOL	-	The command is interrupted
S2+4	Error	BOOL	-	The command execution is error
S2+5	EndOfProfile	BOOL	-	Cam execution completed. When the cam adopts the cycle mode, it will set an Ethernet communication cycle after the end of the current cycle of the cam table, and then reset. When the cam does not adopt the cycle mode, it will be set after the execution of the cam and will not reset automatically.

- The InSync status bit is set to on when the slave axis reaches the slave axis position corresponding to the main axis cam table. Generally, when the slave axis is in the relative mode, execute the CAMIN command, and the status bit will be set to on immediately. When the slave axis is in the absolute or tracking mode, it will be set to on after the slave axis steps or catches up to the slave axis position corresponding to the main axis cam table
- EndOfProfile status bit will be set to on after the slave axis follows the main axis to execute a complete cam table
- StartMode parameter and MasterAbs/SlaverAbs in command CAMTBLSEL decide the main/slave axis motion mode. The main axis mode is only determined by MasterAbs and is not affected by the value in Startmode. The slave axis mode is shown as follows:

StartMode	CAMTBLSEL.SlaveAbs	Slave axis mode
Absolute	Relative	Relative
Absolute	Absolute	Absolute
Relative	Relative	Relative
Relative	Absolute	Relative
Tracking	Relative	Relative
Tracking	Absolute	Absolute

- The result of the absolute/relative mode of the master-slave axis when executing the CAMIN command

Main axis mode	Slave axis mode	Result
Relative	Relative	After CAMIN is executed, the slave axis position does not change. After the main axis runs, the slave axis moves in relative mode as the corresponding points of the cam table
	Absolute	After CAMIN is executed, the slave axis position steps to the starting position of the cam table (i.e. 0). After the main axis runs, the slave axis moves according to the corresponding points of the cam table
	Relative tracking	After CAMIN is executed, the slave axis position doesn't change. After the main axis runs, the slave axis moves in relative mode as the corresponding points of the cam table
	Absolute tracking	After CAMIN is executed, the slave axis tracks to the starting position of cam table (i.e. 0). After the main axis runs, the slave axis moves according to the corresponding points of the cam table
Absolute	Relative	After CAMIN is executed, the slave axis position doesn't change. After the main axis runs, the slave axis moves in relative mode as the corresponding points of the cam table
	Absolute	After CAMIN is executed, the slave axis position steps to the slave position corresponding to the main axis current position in the cam table (eg. Main axis current position is 100, main axis point 100 corresponds to the slave axis point 200 in the cam table. After CAMIN is executed, the slave axis steps to 200). After the main axis runs, the slave axis moves according to the corresponding points of the cam table
	Relative tracking	After CAMIN is executed, the slave axis position doesn't change. After the main axis runs, the slave axis moves in relative mode as the corresponding points of the cam table
	Absolute tracking	After CAMIN is executed, the slave axis tracks to the slave axis position corresponding to the main axis current position in the cam table (eg. The main axis current position is 100, the main axis point corresponds to the slave axis point 200 in the cam table. After CAMIN is executed, the slave axis steps to 200). After the main axis runs, the slave axis moves according to the corresponding points of the cam table

- When the main axis is in absolute mode, if the current position of the main axis is not within the main axis range of the cam table, the automatic action will be processed periodically. For example, if the current position of the main axis is 110 and the position of the main axis in the cam table is 0 ~ 100, the default main axis position after CAMIN is executed is 10 (the actual main axis position does not change).
 - The master-slave axis ratio and master-slave axis offset parameters take effect when CAMIN is executed, and modification in the process is not supported. Inappropriate parameters will lead to slave axis position step. The position relationship between the master and slave axis is (where CAM() represents the slave axis position corresponding to the main axis on the cam table):

$$\text{Slave axis position} = \text{slave axis ratio} \times \text{CAM} ((\text{main axis position} + \text{main axis offset}) / \text{main axis ratio}) + \text{slave axis offset}$$
 - The main-slave axis ratio cannot be 0. When the start mode is tracking mode, S0+32~S0+44 cannot be 0. If these parameters are not set, it will return error code 1009 when the CAMIN is executed.
 - Follow buffer command after CAMIN
 - Follow the command CAMIN
- (1) Multi-cycle: when the EOP signal of the current cam cycle arrives, start the cam movement of the second CAMIN command, and the slave axis position steps to the actual position corresponding to the cam slave axis module value.
 - (2) Single cycle: the second CAMIN instruction is executed during movement, and the processing is the same as that of single cycle. The second CAMIN command is triggered after the end of the movement without any special processing
 - Follow motion command
- (1) Multi-cycle: after the EOP signal of the current cam cycle arrives, start to execute the motion command, and calculate with the actual position of the slave axis as the reference value.
 - (2) Single cycle: trigger the motion command in the cam motion, and the processing is the same as that of multi-cycle. The motion command is triggered after the cam motion is completed without any special treatment

(6) Sequence diagram

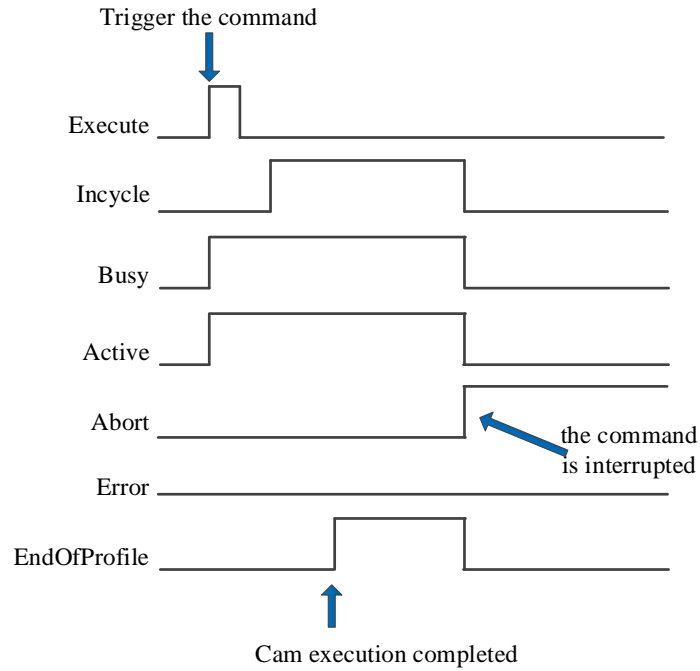

Explanation:

When the cam is not executed periodically, the busy and active signals are set after the command is triggered, and the incycle signal is set after the cam is synchronously bound successfully. If the operation of a single cam cycle is completed, the EOP signal is set. At this time, other motion commands, stop commands or camout commands are triggered for the slave axis, the increment, busy, active and EOP signals are reset, and the abort signal is set.

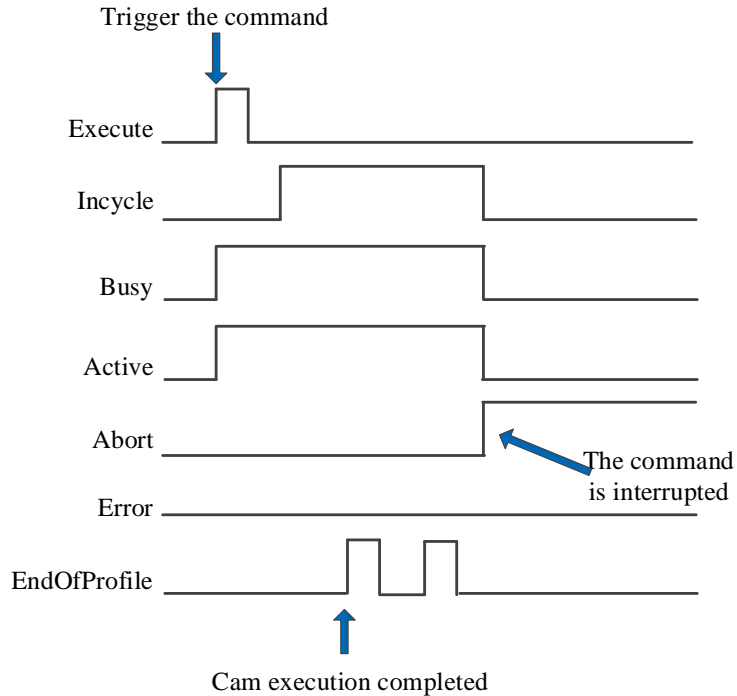

Explanation:

When the cam adopts periodic execution, the EOP signal will be set once, and the other signal states are consistent with non-periodic.

(7) Operation example

CAM table configuration:

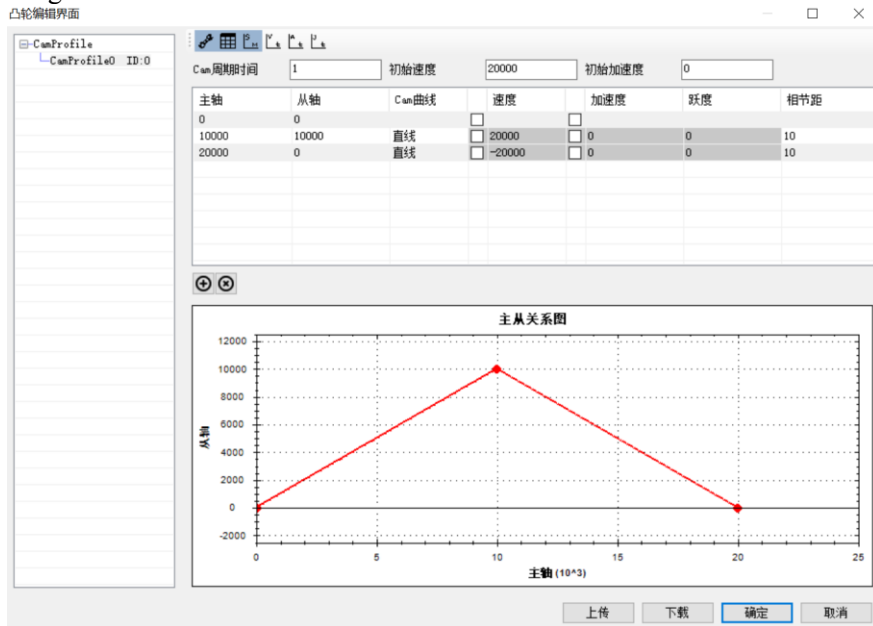

When both the main axis and the slave axis adopt the relative mode, and the starting position of the main axis and the slave axis is 10000, execute the cam table, and its track is shown in the following figure

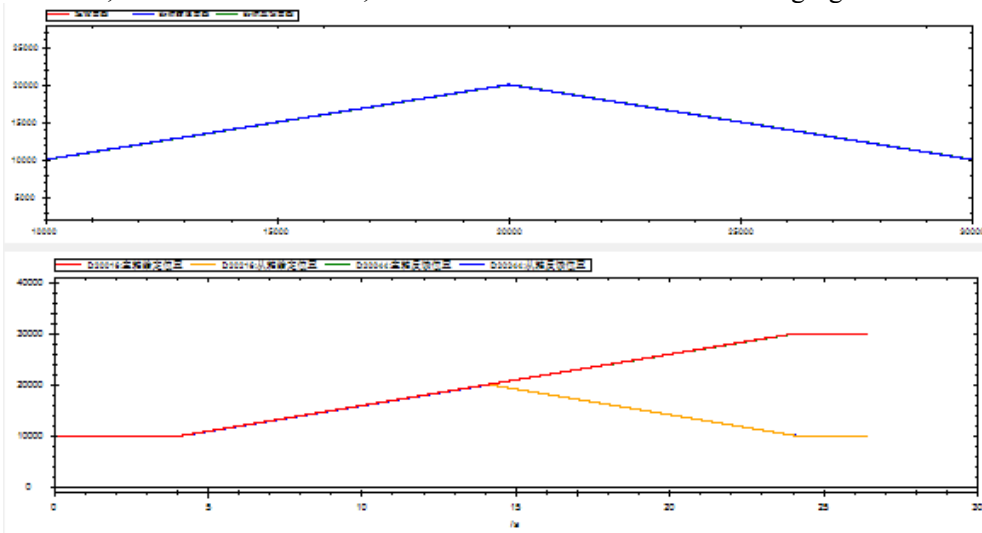

It can be seen that the starting point of the track is (10000,10000), and the entire cam table is executed. When the main axis adopts relative mode and the slave axis adopts absolute mode, and the starting position of the master and slave axis is 10000, the track of the executed cam table is shown in the following figure

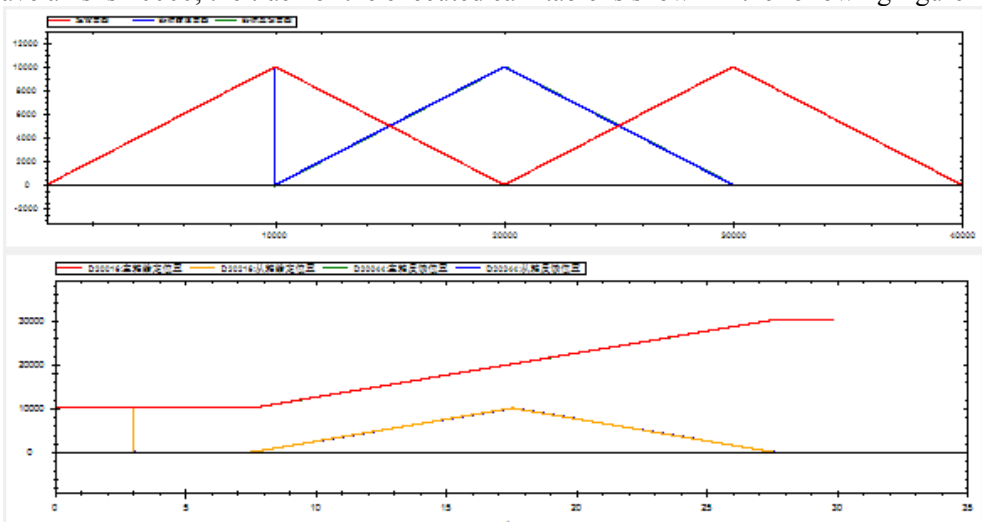

It can be seen that the starting point of the track is (10000,0), and the entire cam table is executed, and the slave axis position produces a step from 10000 to 0 at the beginning.

When the main axis adopts absolute mode and the slave axis adopts relative mode, and the starting position of the master and slave axis is 10000, the track of the executed cam table is shown in the following figure:

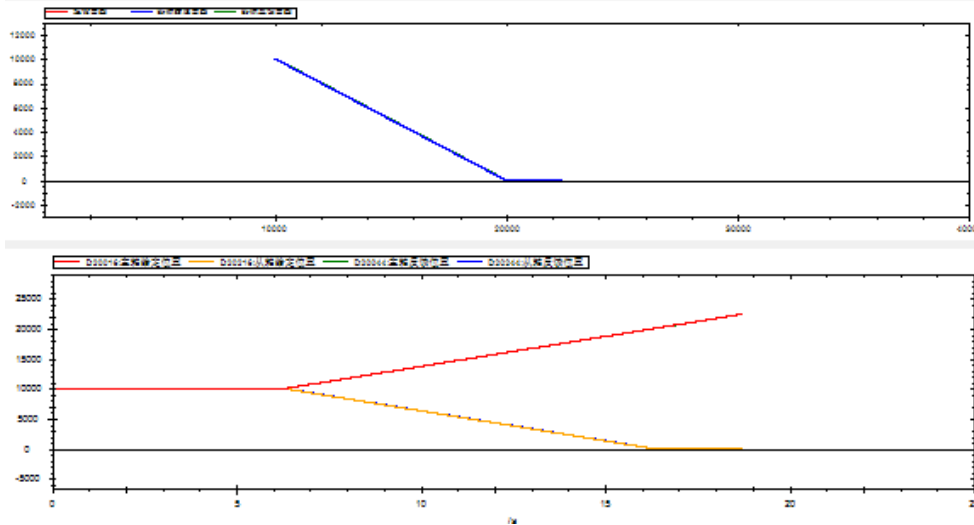

It can be seen that the starting position of the axis does not change, and the subsequent cam table starting from the main axis position 10000 is executed.

When both the main axis and the slave axis adopt the absolute mode, and the starting position of the main axis is 10000 and the starting position of the slave axis is 0, the track of the executed cam table is as follows:

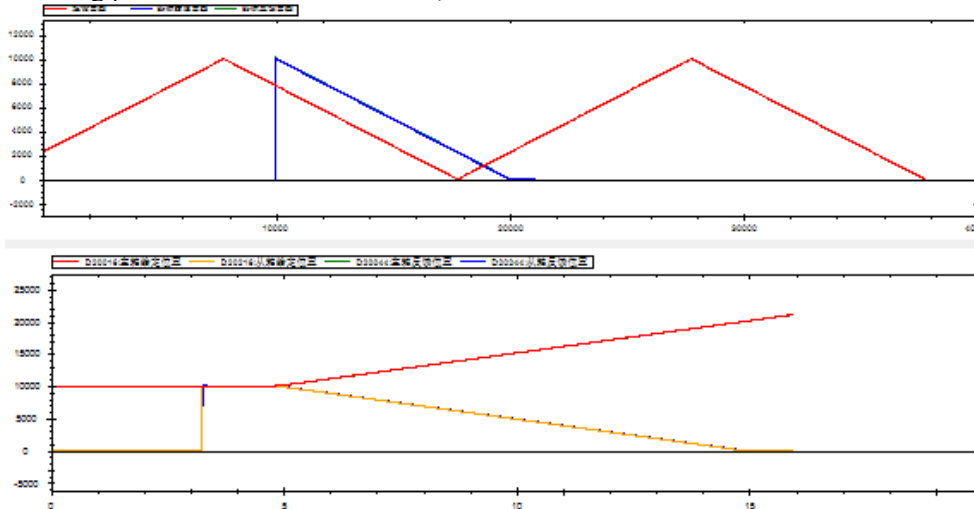

It can be seen that the slave axis position steps from 0 to 10000, the starting point of the track is (10000,10000), the cam table starting from main axis position 10000 is executed.

The tracking mode is similar to the absolute mode, except that if it is in the tracking mode, the slave axis will catch up with the set speed, acceleration and jerk speed without step.

When the movement of the master-slave axis is 10000 per turn, the CAMTBLSEL command adopts the cycle mode. The ratio of the master-slave axis in the CAMIN command is 1 and the offset of the master-slave axis is 0. After the cam is bound, the main axis uses the relative motion command to run the position of 40000 command units. Its trajectory is shown in the figure below:

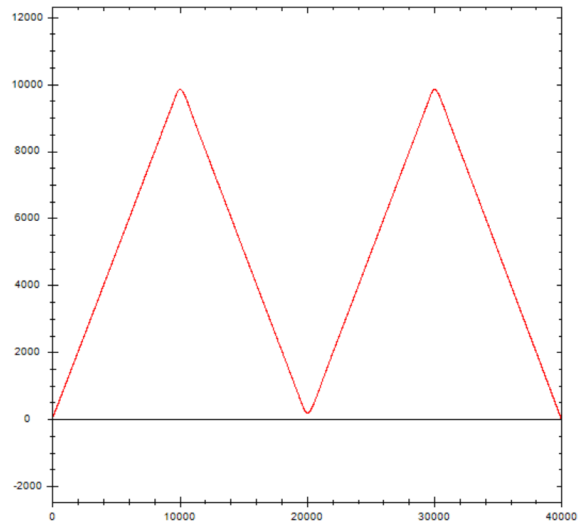

When the main axis ratio is 2, the slave axis ratio is 1 (the main axis becomes twice the original and the slave axis remains the same):

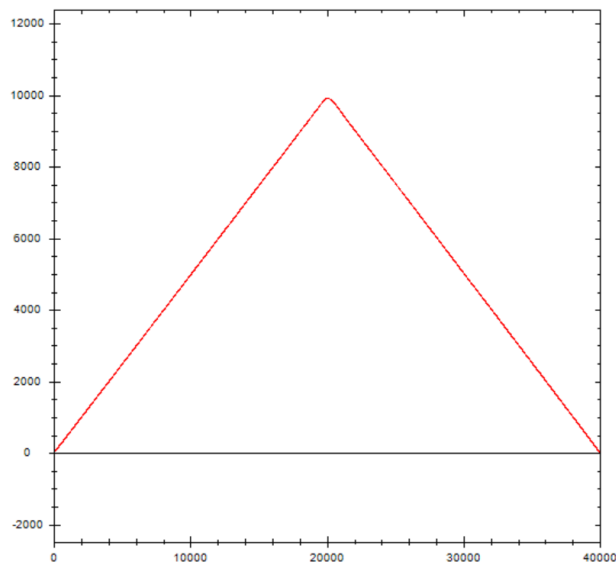

When the main axis ratio is 1, the slave axis ratio is 2 (the slave axis becomes twice the original and the main axis remains the same):

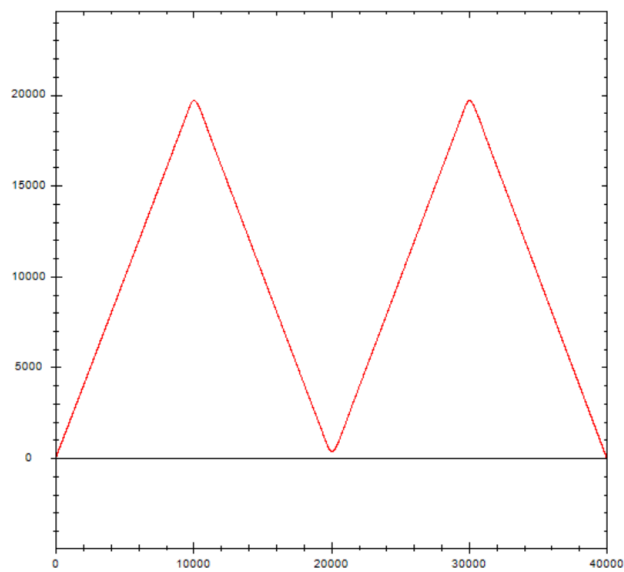

When the main axis ratio is 2, the slave axis ratio is 2 (the main axis and slave axis all become twice the original):

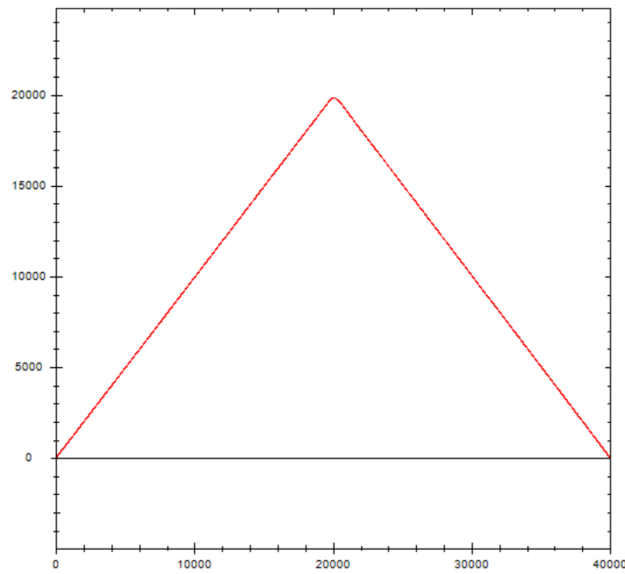

When the ratio of the master-slave axis is 1 and the main axis offset is 5000 (the main axis point of the cam table is offset 5000 to the right, that is, the starting position of the main axis is the position of the main axis 5000 of the original curve, and the curve of the master-slave axis is offset to the left):

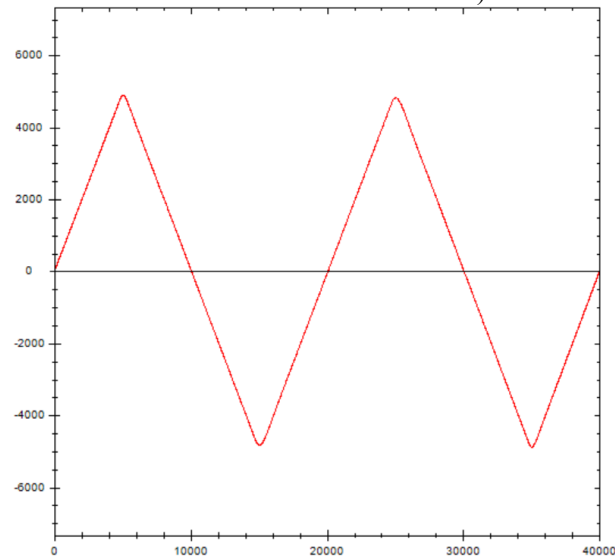

When the ratio of the master and slave axis is 1 and the offset of the slave axis is 5000 (the offset of the slave axis is valid only when the slave axis is in absolute or tracking mode, which will step/catch-up to the offset position when the CAMIN command is triggered, and the alarm of the slave axis may be caused in absolute mode):

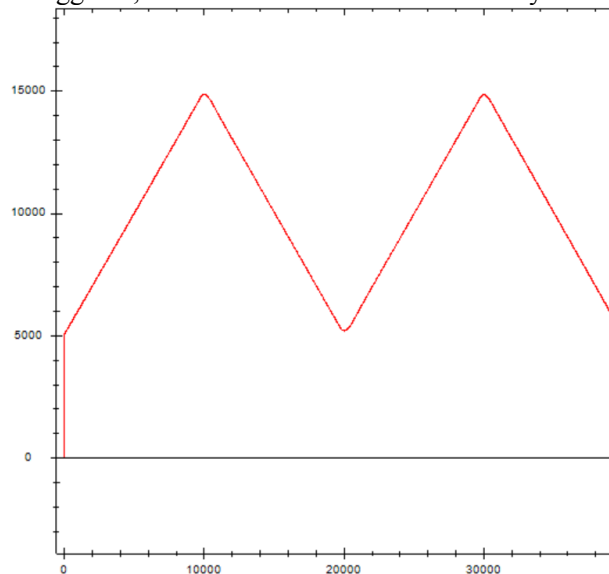

5-3-2-3. CAM release 【CAMOUT】

(1) Overview

Release the CAM relationship between the main and slave axis.

CAM release [CAMOUT]			
Execution condition	Rising/falling edge of the coil	Suitable model	XDH, XLH
Firmware	V3.6.1b and above	Software	V3.7.4 and above

Note: XDH, XLH series -L models cannot support this command.

(2) Operand

Operand	Function	Type
S0	Specify the input parameter start address	16-bit, single word
S1	Specify the output state word start address	16-bit, single word
S2	Specify the output state bit start address	Bit

(3) Suitable soft component

Operand	Word soft component										Bit soft component						
	System								Constant K/H	Module		System					
	D*	FD	TD*	CD*	DX	DY	DM*	DS*		ID	QD	X	Y	M*	S*	T*	C*
S0	●	●	●	●	●	●	●	●									
S1	●	●	●	●	●	●	●	●									
S2														●			

*: D means D, HD; TD means TD and HTD; CD means CD, HCD, HSCD and HSD; DM means DM and DHM; DS means DS and DHS; M means M, HM, SM; S means S, HS; T means T, HT; C means C, HC.

(4) Function and action



- S0 specifies the input parameter start address
- S1 specifies the output parameter start address
- S2 specifies the output state bit start address, occupies the register S2~S2+1
- When M0 is from OFF→ON, release the cam relationship of the slave axis specified by S0

(5) Notes

- If the slave axis is in motion during the execution of CAMOUT, the slave axis will maintain the original speed and continue to run after the command is executed. You can use A_STOP and A_HALT command to stop
- Whether periodic operation or non-periodic operation is adopted, the master and slave axis of CAMIN need to unload the cam table through CAMOUT

(6) Related parameters

Input parameter	Parameter name	Data type	Unit	Note
S0	Slaver	INT16S	-	CAM slave axis number
Output parameter	Parameter name	Data type	Unit	Note
S1	ErrCode	INT16S	-	Command error code
Output state	Parameter name	Data type	Unit	Note
S2	Done	BOOL	-	The command execution is successful
S2+1	Busy	BOOL	-	The command is being executed
S2+2	Error	BOOL	-	The command execution is error

(7) sequence diagram

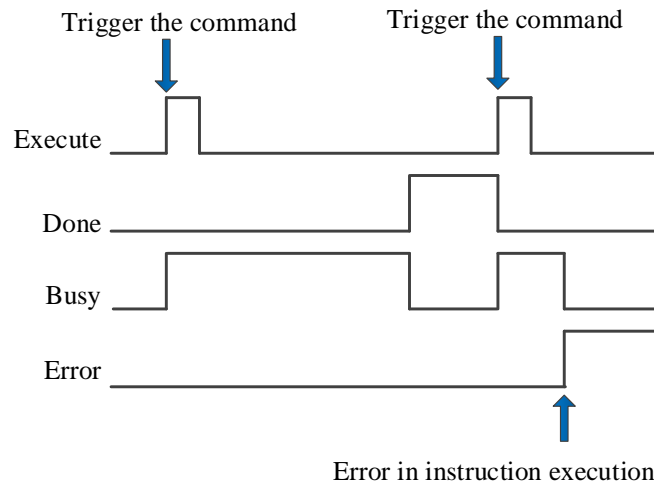

Explanation:

The command is triggered and the Busy signal is set. When the command execution is completed, the Busy signal is reset and the Done signal is set.

When there is an error during instruction execution, the Error signal is set, other signals are reset, and the corresponding error code is output

5-3-2-4. Phase compensation 【CAMPHASE】

(1) Overview

Plan a smooth curve to complete the phase offset of the slave axis relative to the main axis.

Phase compensation [CAMPHASE]			
Execution condition	Rising/falling edge of the coil	Suitable model	XDH, XLH
Firmware	V3.6.1b and above	Software	V3.7.4 and above

Note: XDH, XLH series -L models cannot support this command.

(2) Operand

Operand	Function	Type
S0	Specify the input parameter start address	16-bit, single word
S1	Specify the output state word start address	16-bit, single word
S2	Specify the output state bit start address	Bit

(3) Suitable soft component

Operand	Word soft component										Bit soft component						
	System								Constant K/H	Module		System					
	D*	FD	TD*	CD*	DX	DY	DM*	DS*		ID	QD	X	Y	M*	S*	T*	C*
S0	●	●	●	●	●	●	●	●									
S1	●	●	●	●	●	●	●	●									
S2														●			

*: D means D, HD; TD means TD and HTD; CD means CD, HCD, HSCD and HSD; DM means DM and DHM; DS means DS and DHS; M means M, HM, SM; S means S, HS; T means T, HT; C means C, HC.

(4) Function and action



- S0 specifies the input parameter start address, occupies the register S0~S0+23
- S1 specifies the output parameter start address
- S2 specifies the output state bit start address, occupies the register S2~S2+2
- When M0 is from OFF→ON, when the phase offset of the slave axis to the main axis is executed, the actual position of the main axis will not be affected, and the slave axis will compensate the position according to the offset

(5) Related parameters

Input parameter	Parameter name	Data type	Unit	Note
S0	Slaver	INT16S	-	CAM slave axis number
S0+1	Master	INT16S	-	CAM main axis number
S0+4	PhaseShift	FP64	Command unit	Phase offset
S0+8	Velocity	FP64	Command unit /s	Phase compensation speed
S0+12	Acc	FP64	Command unit /s ²	Phase compensation acceleration
S0+16	Dec	FP64	Command unit /s ²	Phase compensation deceleration
S0+20	Jerk	FP64	Command unit /s ³	Phase compensation jerk speed, which is the acceleration/deceleration change rate
Output parameter	Parameter name	Data type	Unit	Note
S1	ErrCode	INT16S	-	Command error code
Output state	Parameter name	Data type	Unit	Note

S2	Done	BOOL		The command execution is successful
S2+1	Busy	BOOL		The command is being executed
S2+2	Error	BOOL		The command execution is error

(6) Sequence diagram

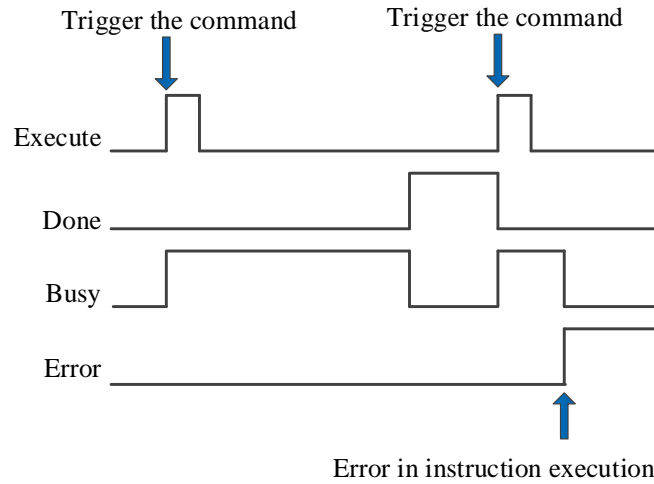

Explanation:

The command is triggered and the Busy signal is set. When the command execution is completed, the Busy signal is reset and the Done signal is set.

When there is an error during instruction execution, the Error signal is set, other signals are reset, and the corresponding error code is output.

(7) Sketch diagram

Dotted line: it is the original curve of the slave axis. Solid line: it is the curve after phase compensation of the slave axis.

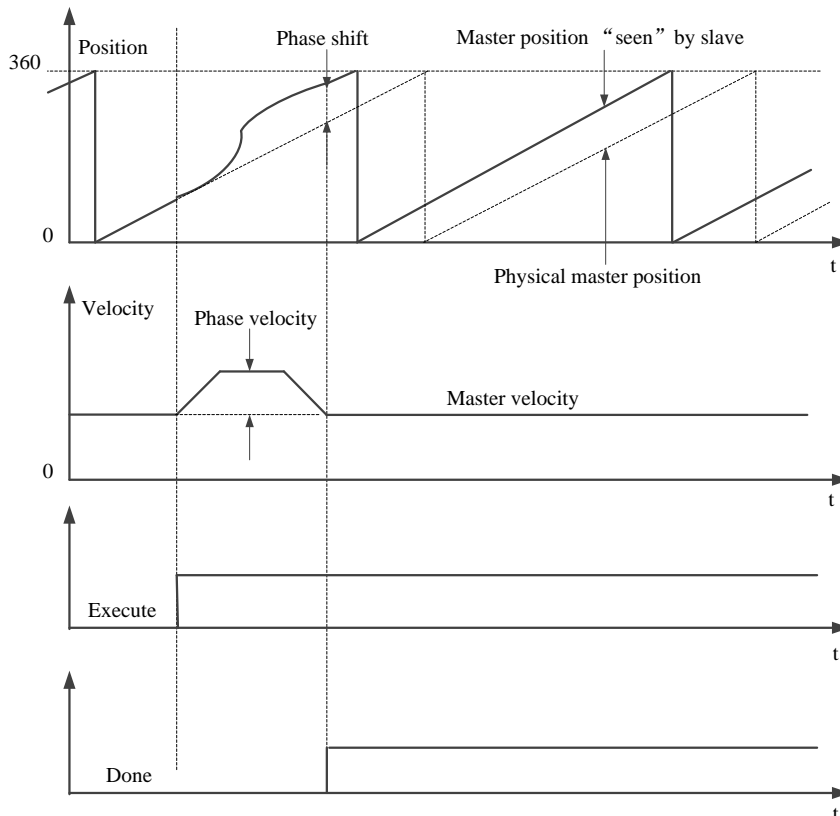

5-3-2-5. CAM table read 【CAMRD】

(1) Overview

Read the point of the cam table.

CAM table read [CAMRD]			
Execution condition	Rising/falling edge of the coil	Suitable model	XDH, XLH
Firmware	V3.6.1b and above	Software	V3.7.4 and above

Note: XDH, XLH series -L models cannot support this command.

(2) Operand

Operand	Function	Type
S0	Specify the input parameter start address	16-bit, single word
S1	Specify the output state word start address	16-bit, single word
S2	Specify the output state bit start address	Bit

(3) Suitable soft component

Operand	Word soft component										Bit soft component						
	System								Constant K/H	Module		System					
	D*	FD	TD*	CD*	DX	DY	DM*	DS*		ID	QD	X	Y	M*	S*	T*	C*
S0	●	●	●	●	●	●	●	●									
S1	●	●	●	●	●	●	●	●									
S2														●			

*: D means D, HD; TD means TD and HTD; CD means CD, HCD, HSCD and HSD; DM means DM and DHM; DS means DS and DHS; M means M, HM, SM; S means S, HS; T means T, HT; C means C, HC.

(4) Function and action



- S0 specifies the input parameter start address, occupies the register S0~S0+1
- S1 specifies the output parameter start address, occupies the register S1~S1+18
- S2 specifies the output state bit start address, occupies the register S2~S2+2
- When M0 is from OFF→ON, read the points of the corresponding cam table according to the cam table instance, and store the read parameters such as position, speed, acceleration and connection type into the register with S1 as the starting address

(5) Related parameters

Input parameter	Parameter name	Data type	Unit	Note
S0	CamTblID	INT16S	-	CAM table instance. Obtain through CAMTBLSEL
S0+1	PointID	INT16S	-	Read key point number (starting from 0)
Output parameter	Parameter name	Data type	Unit	Note
S1	ErrCode	INT16S	-	Command error code
S1+1	Cnt	INT16S	-	Read key point quantity
S1+2	MasterPos	FP64	Command unit	Key point main axis position
S1+6	SlaverPos	FP64	Command unit	Key point slave axis position
S1+10	Vel	FP64	Command unit /s	Key point speed
S1+14	Acc	FP64	Command unit /s ²	Key point acceleration
S1+18	TrajType	INT16S	-	Join type at key point (curve type from previous key point to current key point)*
Output	Parameter	Data type	Unit	Note

state	name			
S2	Done	BOOL	-	The command execution is successful
S2+1	Busy	BOOL	-	The command is being executed
S2+2	Error	BOOL	-	The command execution is error

*Note: join type: 1: Cubic curve 2: quintic curve 3: parabola 4: straight line 5: simple harmonic 6: Cycloid 7: deformation sine 8: deformation trapezoid 9: constant 10: deformation constant velocity 11: double harmonic 12: inverse double harmonic.

(6) Sequence diagram

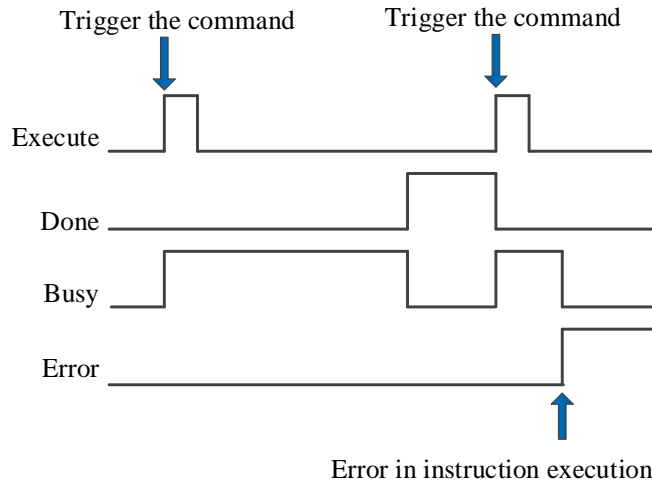

Explanation:

The command is triggered and the Busy signal is set. When the command execution is completed, the Busy signal is reset and the Done signal is set.

When there is an error during instruction execution, the Error signal is set, other signals are reset, and the corresponding error code is output.

5-3-2-6. CAM table write 【CAMWR】

(1) Overview

Change the point in the cam table.

CAM table write [CAMWR]			
Execution condition	Rising/falling edge of the coil	Suitable model	XDH, XLH
Firmware	V3.6.1b and above	Software	V3.7.4 and above

Note: XDH, XLH series -L models cannot support this command.

(2) Operand

Operand	Function	Type
S0	Specify the input parameter start address	16-bit, single word
S1	Specify the output state word start address	16-bit, single word
S2	Specify the output state bit start address	Bit

(3) Suitable soft component

Operand	Word soft component								Bit soft component										
	System								Constant	Module		System							
	D*	FD	TD*	CD*	DX	DY	DM*	DS*	K/H	ID	QD	X	Y	M*	S*	T*	C*		
S0	●	●	●	●	●	●	●	●											
S1	●	●	●	●	●	●	●	●											
S2														●					

*: D means D, HD; TD means TD and HTD; CD means CD, HCD, HSCD and HSD; DM means DM and DHM; DS means DS and DHS; M means M, HM, SM; S means S, HS; T means T, HT; C means C, HC.

(4) Function and action



- S0 specifies the input parameter start address, occupies the register S0~S0+18
- S1 specifies the output parameter start address, occupies the register S1~S1+1
- S2 specifies the output state bit start address, occupies the register S2~S2+2
- When M0 is from OFF→ON, modify the point in the cam table instance

(5) Notes

- Except that the first point (i.e. 0,0) cannot be changed, all other points support modification
- When the curves in the cam table are cubic or quintic curves and straight lines, modifying the point position will affect the trajectories of the before and after curves at most. Improper modified point position may lead to sudden change of slave axis position
- The written point cannot be read by the programming software and becomes invalid after power on again
- The modified point main axis position can only be between the before and after points

(6) Related parameters

Input parameter	Parameter name	Data type	Unit	Note
S0	CamTblID	INT16S	-	CAM table instance. Obtain through the command CAMTBLSEL
S0+1	PointID	INT16S	-	Read the key point number (starts from 0)
S0+2	MasterPos	FP64	Command unit	Key point main axis position
S0+6	SlaverPos	FP64	Command unit	Key point slave axis position
S0+10	Vel	FP64	Command unit /s	Key point speed. Not support at the moment.
S0+14	Acc	FP64	Command unit /s ²	Key point acceleration. Not support at the moment.
S0+18	TrajType	INT16S	-	Join type at the key point. Not support at the

Output parameter	Parameter name	Data type	Unit	moment.	Note
S1	ErrCode	INT16S	-		Command error code
S1+1	Cnt	INT16S	-		Write in key point quantity
Output state	Parameter name	Data type	Unit		Note
S2	Done	BOOL	-		The command execution is successful
S2+1	Busy	BOOL	-		The command is being executed
S2+2	Error	BOOL	-		The command execution is error

(7) Sequence diagram

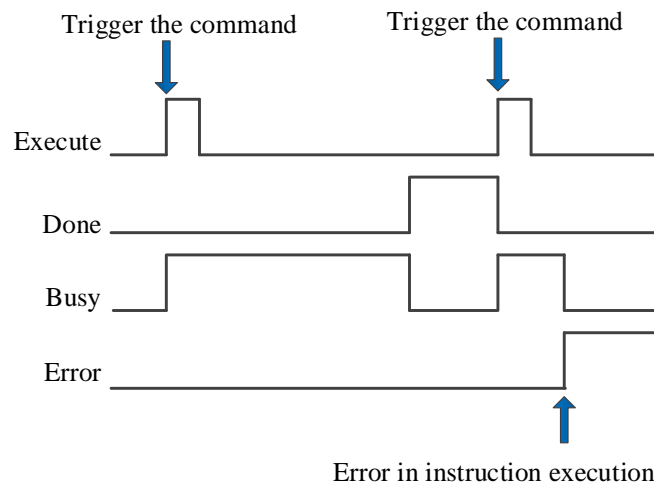

Explanation:

The command is triggered and the Busy signal is set. When the command execution is completed, the Busy signal is reset and the Done signal is set.

When there is an error during instruction execution, the Error signal is set, other signals are reset, and the corresponding error code is output.

5-3-2-7. Add key point 【CAMPOINTADD】

(1) Overview

Add the key point in the specified cam table.

Add key point [CAMPOINTADD]			
Execution condition	Rising/falling edge of the coil	Suitable model	XDH, XLH
Firmware	V3.7.1 and above	Software	V3.7.4 and above

Note: XDH, XLH series -L models cannot support this command.

(2) Operand

Operand	Function	Type
S0	Specify the input parameter start address	64-bit, four words
S1	Specify the output state word start address	16-bit, single word
S2	Specify the output state bit start address	Bit

(3) Suitable soft component

Operand	Word soft component										Bit soft component						
	System								Constant K/H	Module		System					
	D*	FD	TD*	CD*	DX	DY	DM*	DS*		ID	QD	X	Y	M*	S*	T*	C*
S0	●	●	●	●	●	●	●	●									
S1	●	●	●	●	●	●	●	●									
S2														●			

*: D means D, HD; TD means TD and HTD; CD means CD, HCD, HSCD and HSD; DM means DM and DHM; DS means DS and DHS; M means M, HM, SM; S means S, HS; T means T, HT; C means C, HC.

(4) Function and action



- S0 specifies the input parameter start address
- S1 specifies the output state word start address
- S2 specifies the output state bit start address
- When M0 is from OFF→ON, [cam table instance] specifies the cam table and add corresponding key points. After the command is executed, the end index of the cam table is output.

(5) Notes

- You can only add a key point after the first key point in the cam table
- If pointid does not exist in the cam table, a key point is added after the last key point in the cam table by default. If pointid exists, the key points of cam table need to be increased by one bit in turn.
- The main axis position of the new key point in the middle of cam table can only be within the curve of the current section. Adding the main axis position of the key point at the end of the cam table can only be greater than the main axis position of the termination key point, otherwise the command will report an error
- A cam table can store up to 1000 key points

(6) Related parameters

Input parameter	Parameter name	Data type	Unit	Note
S0	CamTblId	INT16S	-	CAM table instance number
S0+1	PointId	INT16U	-	Cam table key point number
S0+4	MasterPos	FP64	-	Main axis position
S0+8	SlaverPos	FP64	-	Slave axis position
S0+12	Vel	FP64	-	Reference speed
S0+16	Acc	FP64	-	Reference acceleration

Input parameter	Parameter name	Data type	Unit	Note
S0+20	Type	INT16U	-	Join trajectory type
S0+21	Mode	INT16U	-	Take effect mode 0: take effect at once 1: take effect in next cam cycle, not support at the moment
Output parameter	Parameter name	Data type	Unit	Note
S1	ErrCode	INT16U	-	Command error code
S1+1	EndPointIndex	INT16U	-	Cam table end point index
State parameter	Parameter name	Data type	Unit	Note
S2	Done	BOOL	-	The command execution completed
S2+1	Busy	BOOL	-	The command is being executed
S2+2	Error	BOOL	-	The command execution is error

(7) Sequence diagram

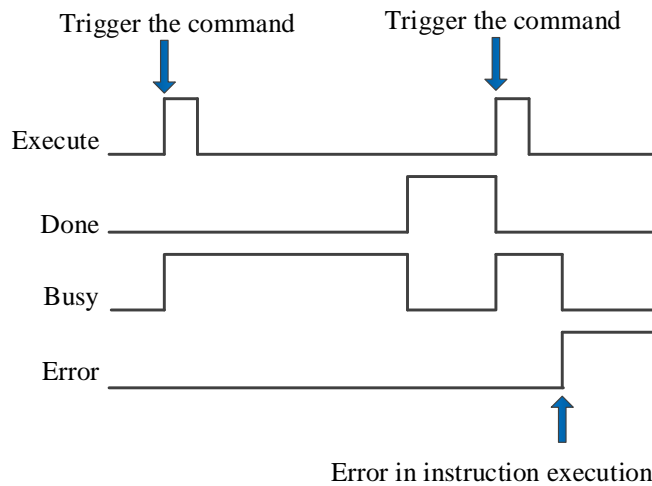

Explanation:

The command is triggered and the Busy signal is set. When the command execution is completed, the Busy signal is reset and the Done signal is set.

When there is an error during instruction execution, the Error signal is set, other signals are reset, and the corresponding error code is output.

5-3-2-8. Key point delete 【CAMPOINTDEL】

(1) Overview

Delete the key point in the specified cam table.

Key point delete [CAMPOINTDEL]			
Execution condition	Rising/falling edge of the coil	Suitable model	XDH, XLH
Firmware	V3.7.1 and above	Software	V3.7.4 and above

Note: XDH, XLH series -L models cannot support this command.

(2) Operand

Operand	Function	Type
S0	Specify the input parameter start address	64-bit, four words
S1	Specify the output state word start address	16-bit, single word
S2	Specify the output state bit start address	Bit

(3) Suitable soft component

Operand	Word soft component										Bit soft component						
	System								Constant	Module		System					
	D*	FD	TD*	CD*	DX	DY	DM*	DS*	K/H	ID	QD	X	Y	M*	S*	T*	C*
S0	●	●	●	●	●	●	●	●									
S1	●	●	●	●	●	●	●	●									
S2														●			

*: D means D, HD; TD means TD and HTD; CD means CD, HCD, HSCD and HSD; DM means DM and DHM; DS means DS and DHS; M means M, HM, SM; S means S, HS; T means T, HT; C means C, HC.

(4) Function and action



- S0 specifies the input parameter start address
- S1 specifies the output state word start address
- S2 specifies the output state bit start address
- When M0 is from OFF→ON, for the cam table specified in the [cam table instance], delete the key point specified in the [key point serial number], and output the end point index of the cam table after the command is executed

(5) Notes

- You can only delete a key point after the first key point in the cam table
- Deleting the key points in the middle of the cam table needs to ensure the continuous speed of the previous section and the last two sections of the curve. Deleting key points at the end of the cam table needs to ensure that the speed of the previous curve is continuous
- After deleting key points, if the starting and ending slave axis position of cubic and quintic curves are equal, the command will report an error
- Pointid can be found in the cam table. Delete the corresponding key point, and the key point serial number after the key point needs to be backward one bit in turn. If pointid cannot be found in the cam table, the command will report an error

(6) Related parameters

Input parameter	Parameter name	Data type	Unit	Note
S0	CamTblId	INT16S	-	Cam table instance number
S0+1	PointId	INT16U	-	Cam table key point number

S0+2	Mode	INT16U	-	Take effect mode 0: take effect at once 1: take effect in next cam cycle, not support at the moment
Output parameter	Parameter name	Data type	Unit	Note
S1	ErrCode	INT16U	-	Command error code
S1+1	EndPointIndex	INT16U	-	Cam table end point index
State parameter	Parameter name	Data type	Unit	Note
S2	Done	BOOL	-	The command execution completed
S2+1	Busy	BOOL	-	The command is being executed
S2+2	Error	BOOL	-	The command execution is error

(7) Sequence diagram

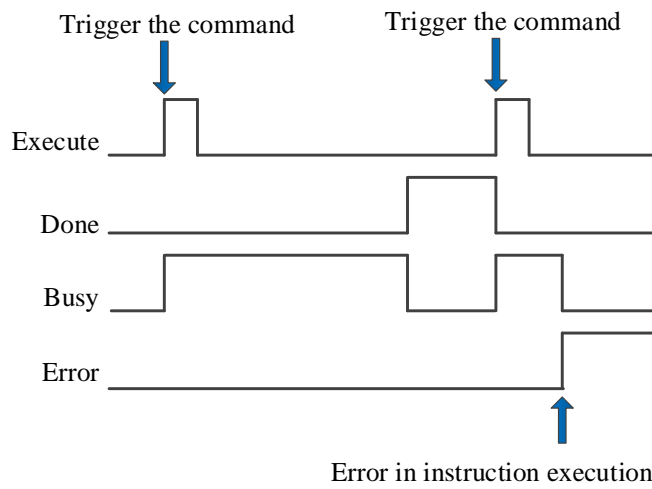

Explanation:

The command is triggered and the Busy signal is set. When the command execution is completed, the Busy signal is reset and the Done signal is set.

When there is an error during instruction execution, the Error signal is set, other signals are reset, and the corresponding error code is output.

5-3-2-9. CAM table unload 【CAMTBLDEL】

(1) Overview

Unload the loaded cam table, release the buffer space.

CAM table unload [CAMTBLDEL]			
Execution condition	Rising/falling edge of the coil	Suitable model	XDH, XLH
Firmware	V3.6.1b and above	Software	V3.7.4 and above

Note: XDH, XLH series -L models cannot support this command.

(2) Operand

Operand	Function	Type
S0	Specify the input parameter start address	16-bit, single word
S1	Specify the output parameter start address	16-bit, single word
S2	Specify the output state bit start address	Bit

(3) Suitable soft component

Operand	Word soft component											Bit soft component					
	System								Constant K/H	Module		System					
	D*	FD	TD*	CD*	DX	DY	DM*	DS*		ID	QD	X	Y	M*	S*	T*	C*
S0	●	●	●	●	●	●	●	●									
S1	●	●	●	●	●	●	●	●									
S2														●			

*: D means D, HD; TD means TD and HTD; CD means CD, HCD, HSCD and HSD; DM means DM and DHM; DS means DS and DHS; M means M, HM, SM; S means S, HS; T means T, HT; C means C, HC.

(4) Function and action



- S0 specifies the input parameter start address
- S1 specifies the output parameter start address
- S2 specifies the output state bit start address, occupies the register S2~S2+2
- When M0 is from OFF→ON, unload the cam table instance specified by S0

(5) Notes

- No matter whether the cam is executed periodically or not, CAMOUT is required before CAMTBLDEL can be executed after CAMIN is executed
- The running cam cannot be unloaded
- Cam table unloading only deletes the corresponding cam table instance number to free the buffer space. You can load a new cam table instance through CAMTBLSEL instruction.
- If the slave axis is stop or broken by the command A_STOP or A_HALT, the cam binding state of the slave axis will also be released. At this time, the CAMTBLDEL command can be executed without the CAMOUT command

(6) Related parameters

Input parameter	Parameter name	Data type	Unit	Note
S0	CamTblID	INT16S	-	CAM table instance, obtain through the command CAMTBLSEL
Output parameter	Parameter name	Data type	Unit	Note
S1	ErrCode	INT16S	-	Command error code
Output state	Parameter name	Data type	Unit	Note

S2	Done	BOOL	-	The command execution is successful
S2+1	Busy	BOOL	-	The command is being executed
S2+2	Error	BOOL	-	The command execution is error

(7) Sequence diagram

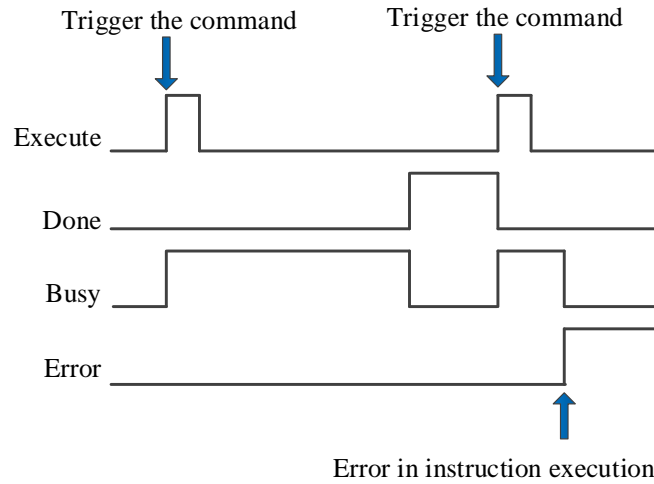

Explanation:

The command is triggered and the Busy signal is set. When the command execution is completed, the Busy signal is reset and the Done signal is set.

When there is an error during instruction execution, the Error signal is set, other signals are reset, and the corresponding error code is output.

5-3-3. CAM configuration in the software

5-3-3-1. Open the cam table configuration

Click the CAM in the project bar to open the cam table configuration interface:

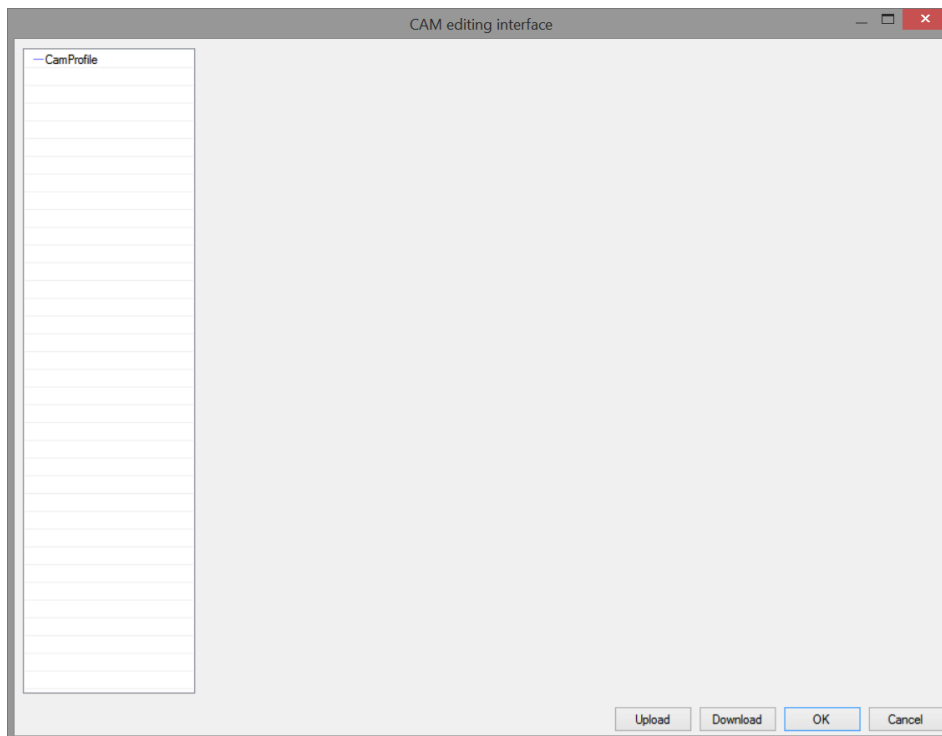
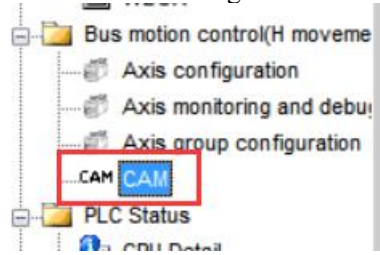

5-3-3-2. Create a new CAM table

Right click [CamProfile], choose [New]:

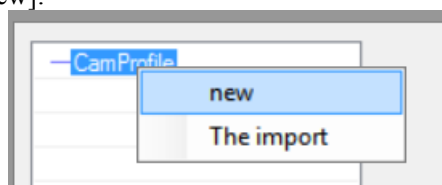

The interface after creating:

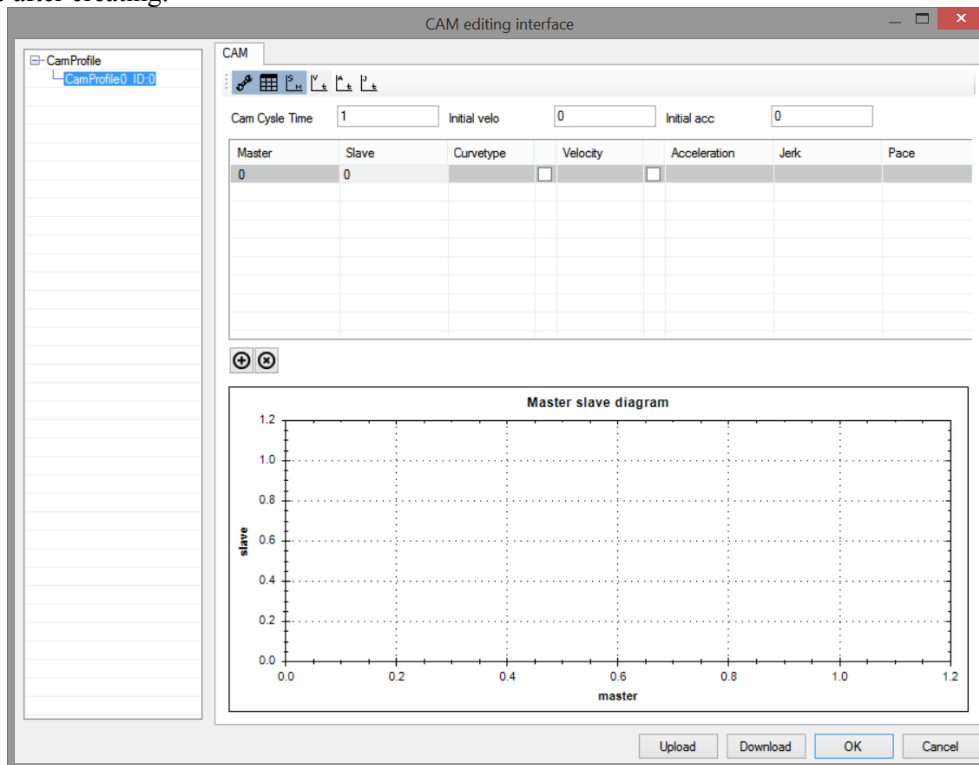

Multiple cam tables can be created. Cam tables are distinguished by CAMID, which can be modified manually:

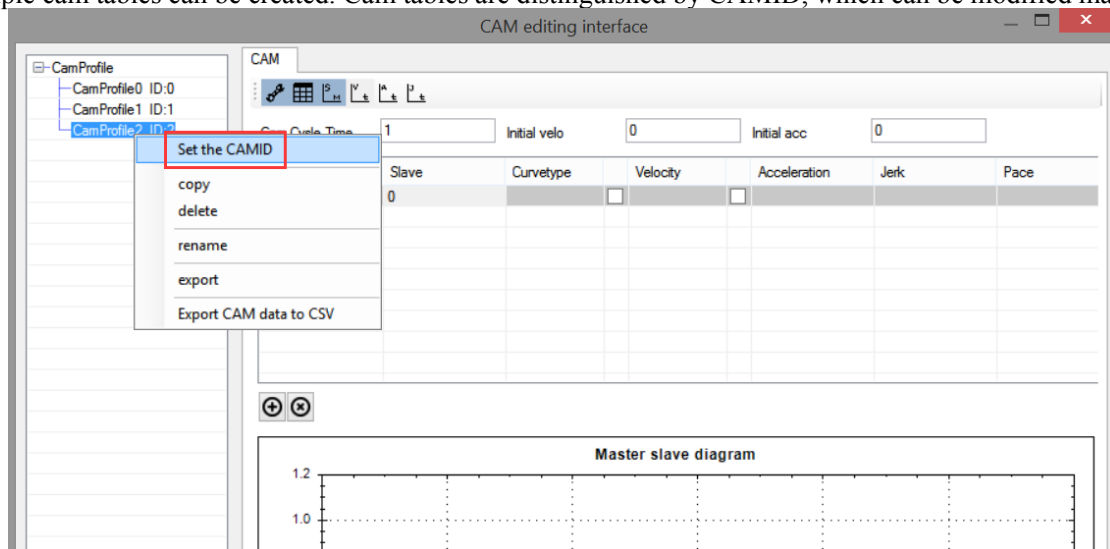

5-3-3-3. Add the cam table point

After the cam table is created, right-click in the cam table editing interface and click [add] to add the key points of the cam table (up to 1000 points in a single cam table, and the total key points in all tables do not exceed 65535). The added points can be changed by dragging in the master-slave relationship diagram, or double clicking on the master and slave axes in the cam table editing interface:

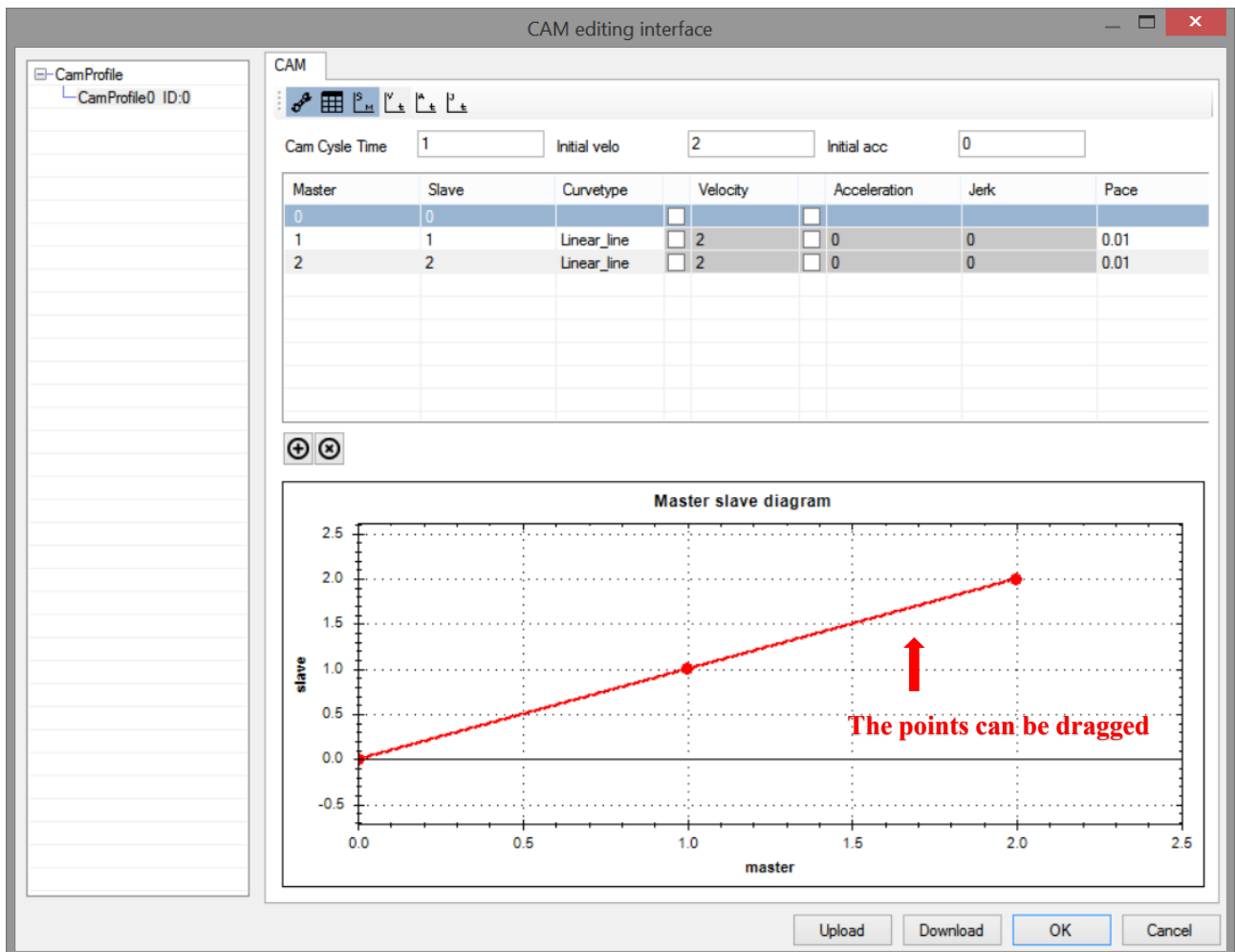
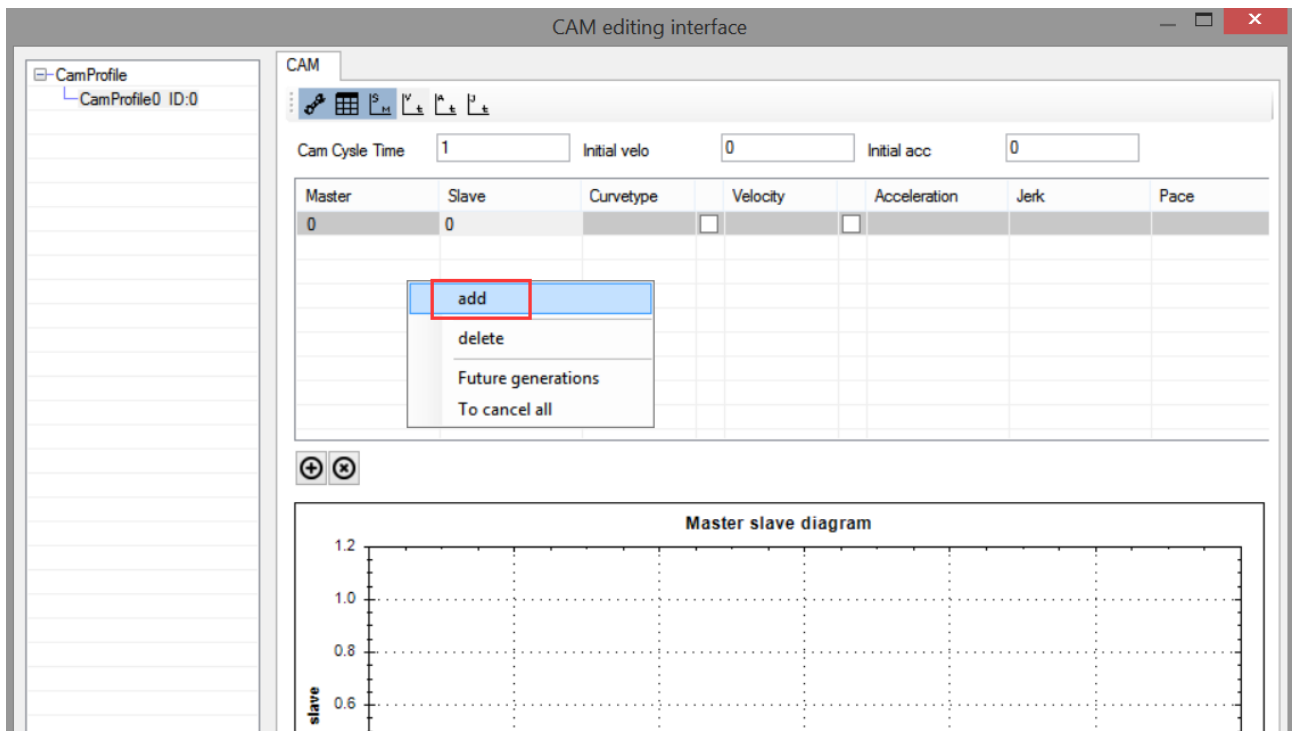

[main axis]: The point position of the main axis can be changed manually by double clicking. The subsequent point position must be greater than the previous point position. The number of main axis points cannot exceed 65535. The number of main axis points = (main axis final point position – main axis starting point position) / pace

[slave axis]: The point position of the slave axis can be changed manually by double clicking.

[curve type]: Type of curve connection between points. Currently supported curve types: constant; Straight line; Parabola; Constant deformation velocity; Deformed trapezoid; Deformation sine; Cycloid; Simple harmonic; Double harmonic; Inverse double harmonic; Cubic curve; Quintic curve.

[velocity]: Automatic calculation. Only when the [curve type] is cubic curve or quintic curve, check the box and manually modify the speed value. (improper speed value may lead to step of point)

[acceleration]: Automatic calculation. The acceleration value can be modified manually only when the [curve type] is a quintic curve. (improper acceleration value may lead to step of point position)

[jerk]: Automatic calculation. Cannot be modified.

[pace]: For the data interval between points, the smaller the pace, the higher the curve accuracy, and the number of main axis points = (main axis final point – main axis starting point) / pace.

[upload]: The downloaded cam table can be uploaded to the programming software through the upload button.

[download]: The configured cam table needs to be downloaded to make it effective. Only xnet protocol download is supported.

[ok]: save the modification for the cam table.

[cancel]: cancel the modification for the cam table.

5-3-3-4. Export the cam table

Right click the cam table to show the export option.

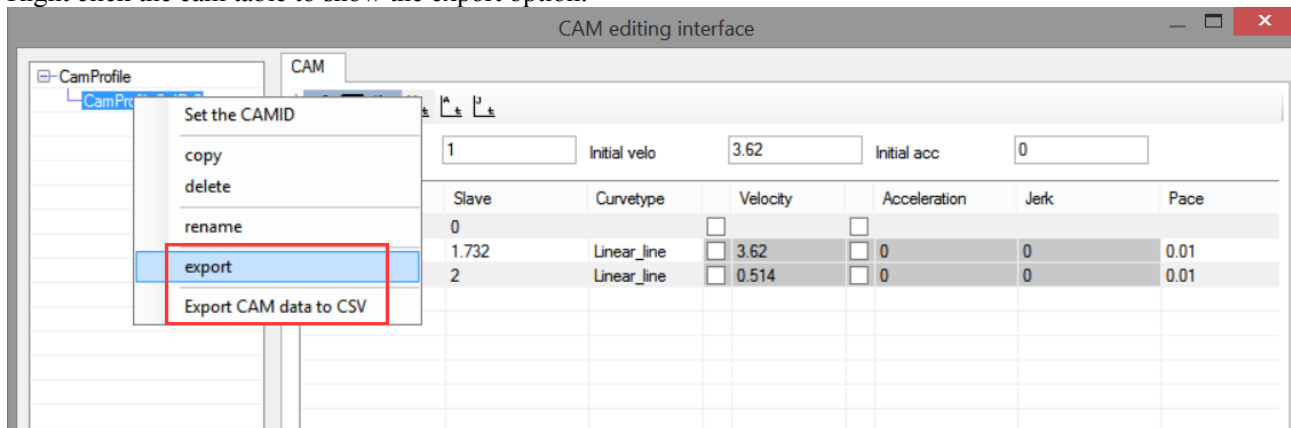

[export]: The cam table is exported. The generated file can be imported again in the cam table editing interface. The generated file is only a description file and does not contain the points in the cam table.

[export CAM data to CSV]: Export the points in cam table to generate excel table, including each point (key point and intermediate point) of master-slave relationship, and the interval of intermediate points is pace.

Right click the CamProfile, click [import] to read the exported cam table into the editing software.

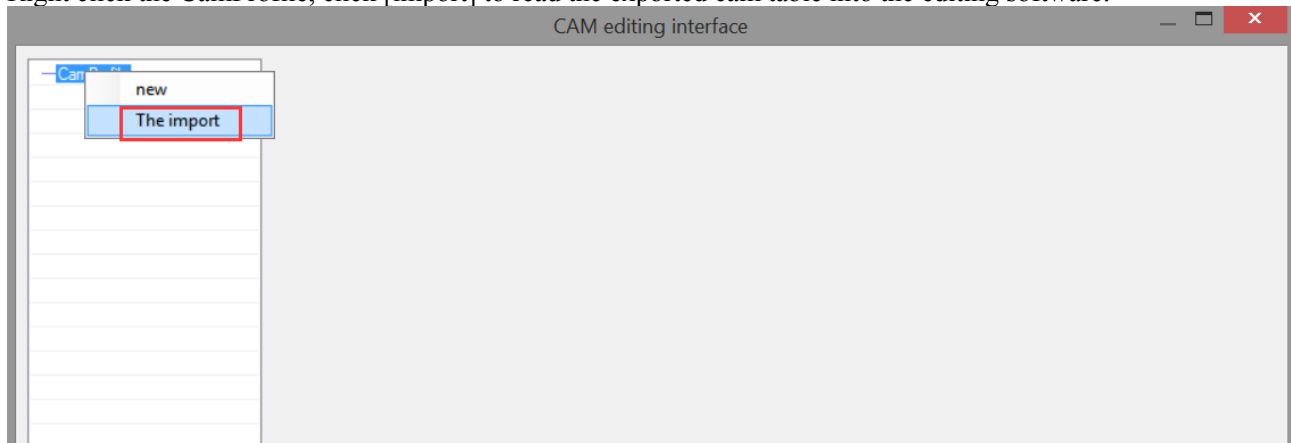

6. Motion command application

6-1. Single axis function application

Taking Xinje DS5C as an example, the slave station runs 1310720 distance based on the current position at the speed of 131072. The operation method is as follows:

① When the slave station is an EtherCAT device, EtherCAT configuration is required first. Click [scan] in EtherCAT configuration interface:

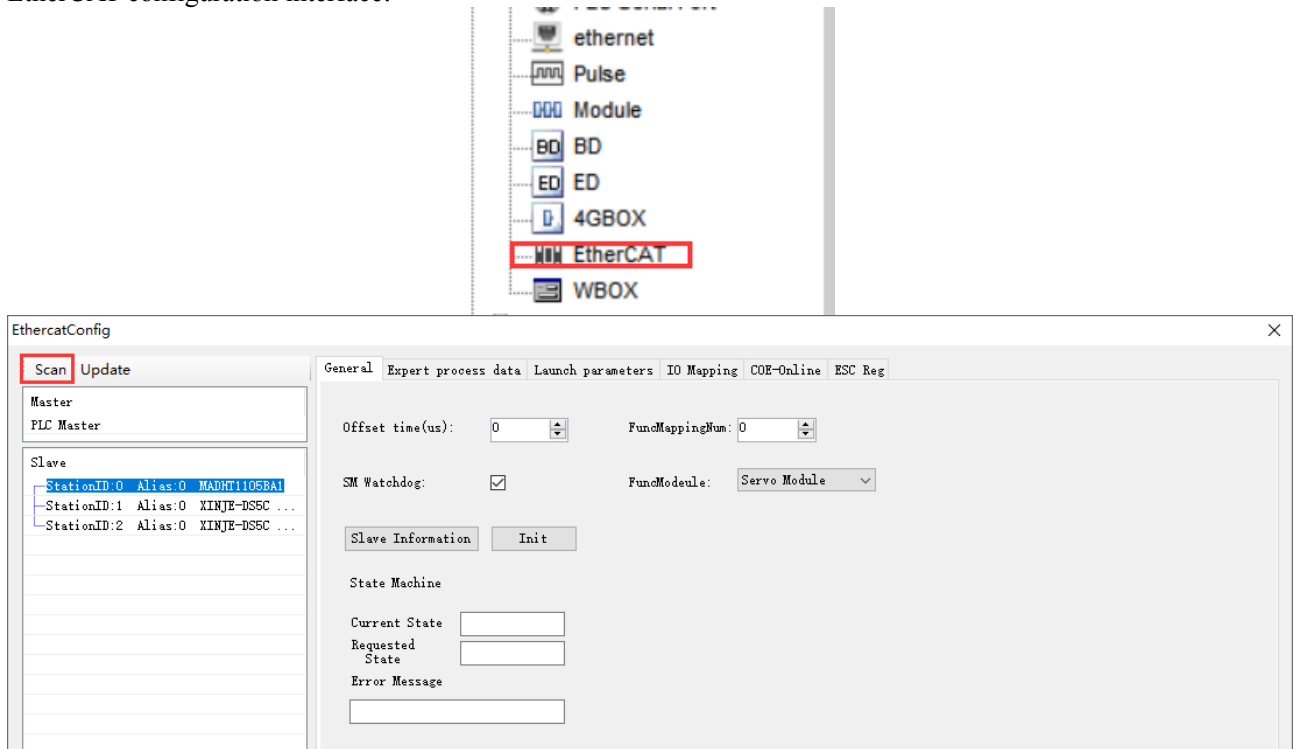

② confirm the PDO in the [expert process data] (The default configuration can meet the use of instructions. If necessary, other relevant parameters can be added).

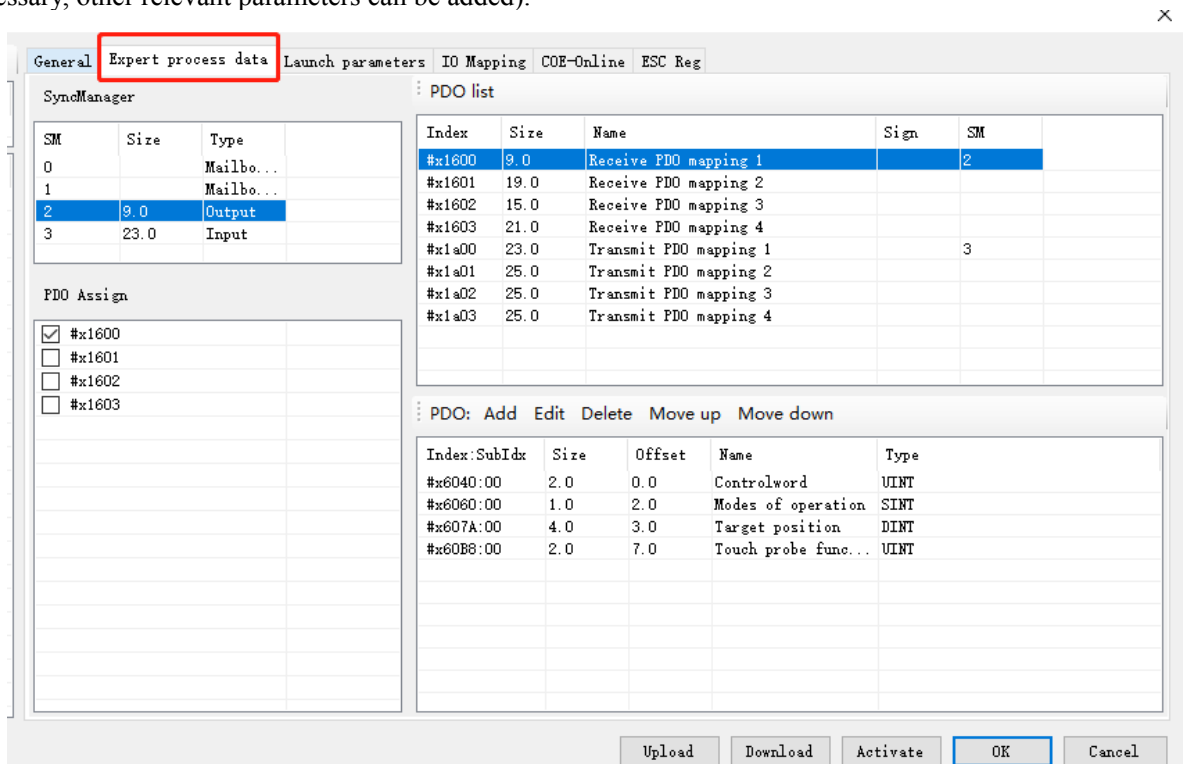

③ confirm the value of 6060h is 8 in [launch parameters]. 6060h value 8 represents the slave station is CSP mode.

Row	Index: subindex	Name	Value	Bits ...	Error ->...	Error ->...	Next row	Notes
1	#x6060:00	Modes of operation	8	8	<input type="checkbox"/>	<input type="checkbox"/>	0	Op mode
2	#x60C2:01	Interpolation ti...	1	8	<input type="checkbox"/>	<input type="checkbox"/>	0	Interpolation time period
3	#x60C2:02	Interpolation ti...	-3	8	<input type="checkbox"/>	<input type="checkbox"/>	0	Interpolation time index

④ [IO mapping] is the PDO mapping register address, the default starting address is HD10000, they can be modified as needs.

Index:SubIdx	Name	Address	Type	Bit length	Value
#x6040:00	Control Word	HD10024	UINT	16	0
#x607A:00	TargetPosition	HD10026	DINT	32	0
#x60FF:00	TargetVelocity	HD10028	DINT	32	0
#x6071:00	TargetTorque	HD10030	INT	16	0
#x6060:00	ModesOfOperation	HD10032	STWT	8	0

⑤ after the parameter configuration, click [download]→[activate].

⑥ after activating, slave station state machine (SD8021) is from 1→2→4→8, 8 means OP state. At this time, SDO, PDO can send and receive data, the communication connection is built.

⑦ confirm the command channel (SFD8001+300*N) in axis configuration is Ethercat (register value is 0).

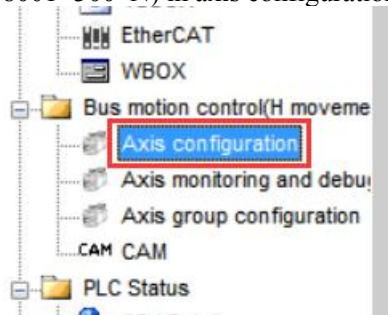

Parameter names	address	Offline values	Online value	type	Parameter effec...	instructions
<input type="checkbox"/> Shaft type	SFD8000	Real axis		ENUM	Power back on	
<input type="checkbox"/> Command cha...	SFD8001	EtherCAT		ENUM	Power back on	Communication mode between controller and servo
<input type="checkbox"/> From the stan...	SFD8002	0		INT16U	Power back on	Slave function mapping number corresponds
<input type="checkbox"/> unit	SFD8003	pulse		ENUM	Power back on	
<input type="checkbox"/> Number of pul...	SFD8004	0		INT32U	Power back on	The number of feedback pulses in one rotation from the station
<input type="checkbox"/> Encoder input...	SFD8006	0		INT16U	Power back on	High speed counting terminal
<input type="checkbox"/> Gantry mode	SFD8007	Is not enabled		ENUM	Power back on	If it is a slave shaft of gantry structure, when the value is 1, the master and slave shaft alarm will not release the binding relat
<input type="checkbox"/> The amount o...	SFD8008	0		FP64	Power back on	
<input type="checkbox"/> Start reductio...	SFD8012	Is not enabled		ENUM	Power back on	
<input type="checkbox"/> Side coeffic...	SFD8014	0		INT32U	Power back on	
<input type="checkbox"/> Side coeffic...	SFD8016	0		INT32U	Power back on	
<input type="checkbox"/> Direction of m...	SFD8018	Do not reverse		ENUM	Power back on	0: Forward rotation of the motor in the direction of pulse increment; 1: Motor reversal in pulse increment direction;
<input type="checkbox"/> Position instru...	SFD8019	0		INT16U	Power back on	Unit: ms
<input type="checkbox"/> Count type	SFD8020	A straight line		ENUM	Power back on	Straight line: linear axis. If the soft limit is enabled, the over-limit alarm will occur. Rotation: Die axis, counting within a limited ran
<input type="checkbox"/> Upper limit of ...	SFD8024	0		FP64	Power back on	Axis effective
<input type="checkbox"/> Lower limit of ...	SFD8028	0		FP64	Power back on	Axis effective
<input type="checkbox"/> Back gap com...	SFD8032	0		FP64	Power back on	
<input type="checkbox"/> Stop mode	SFD8036	Given to stop		ENUM	Power back on	0: Given stop, the given position is unchanged when triggering emergency stop; 1: The feedback stops. When the stop is trig

⑧ After confirming the parameters, enables the specified axis through A_PWR command. After successful enabling, the axis will move through the corresponding single axis command (take A_MOVER as an example here). During operation, the current axis state is monitored through D20000 + 200*N (single word), the current given position is monitored through D20016 + 200*N (double precision), the current feedback position is monitored through D20044 + 200*N (double precision), and the current given speed is monitored through D20020 + 200*N (double precision).

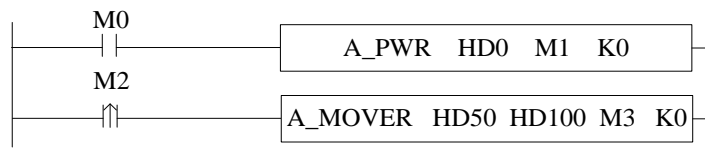

A_MOVERInstruction parameter configuration

Input parameter: HD50 Output parameter: HD100 Status parameter: M3

Effective axis num: K0

Name	Addr	Online value	Offline value	Data type	statement
Input parameter					
Pos	HD50	0	1310720	FP64	Target relative position
Vel	HD54	0	131072	FP64	The target velocity, u/s
Acc	HD58	0	655360	FP64	Acceleration, u/s^2
Dec	HD62	0	655360	FP64	Minus the velocity, u/s^2
Jerk	HD66	0	1310720	FP64	Plus acceleration, u/s^3
ContinuousMode	HD70	Donotupdate	Donotupdate	INT16U	Continuously updated
Direction	HD71	Positivedirection	Positivedirection	INT16U	The direction of
BufferMode	HD72	interrupt	interrupt	INT16U	The caching pattern
Output parameter					
ErnCode	HD100	0		INT16U	Error code
Status parameter					
Done	M3	False		BIT	Completion status
Busy	M4	False		BIT	busy
Active	M5	False		BIT	active
Abort	M6	False		BIT	Interrupt status
Err	M7	False		BIT	Error status

space usage : ID50-HD72,HD100-HD100,M3-M7

Write Ok Cancel

In motion:

PLC1-自由监控1

监控窗口 | 添加 修改 删除 删除全部

寄存器	监控值	字长	进制	注释
D20016	229244.92799148	双...	...	
D20044	225423	双...	...	
D20020	131072	双...	...	
D20000	2	单...	...	

The given position (D20016) and the current position (D20044) are constantly changing. The current given speed (D20020) is the speed 131072 set in the command, and the current axis state (D20000) is 2, indicating that the axis is in the motion state with the termination speed of 0.

After motion:



寄存器	监控值	字长	进制	注释
D20016	1310720	双...	...	
D20044	1310720	双...	...	
D20020	0	双...	...	
D20000	1	单...	...	

The given position (D20016) and the current position (D20044) are the final position 1310720 set in the command, the current given speed (D20020) is 0, and the current axis state (D20000) is 1, indicating that the axis is in the enabled static state.

Note: the current position (D20044) is the actual feedback position, which will fluctuate up and down around the final position, and the fluctuation is affected by the number of pulses per cycle.

6-2. Axis group function application

Take Xinje DS5C as an example, the axis group contains axis 0,1,2, the motion track is a line from (0,0,0) to (100000,150000,0) connecting an arc passing the point (150000,130000,0), the end point is (200000,0,0). The operation method is as the following:

Ethercat configuration is same to chapter 6-1 step ①~⑦.

⑧ set the axis group kinematics type and axis number.

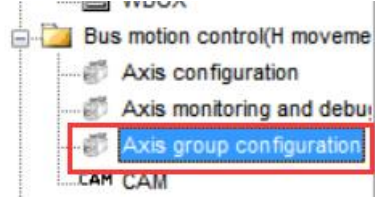

Parameter names	addresses	Offline values	Online value	type	Parameter effec...	instructions
<input type="checkbox"/> Kinematic type	SFD48000	XYZ	XYZ	ENUM	Power back on	
<input type="checkbox"/> Configure axi...	SFD48001	0	0	INT16U	Power back on	Uniaxial number match, 65535 is invalid
<input type="checkbox"/> Configure axi...	SFD48002	1	1	INT16U	Power back on	Uniaxial number match, 65535 is invalid
<input type="checkbox"/> Configure axi...	SFD48003	2	2	INT16U	Power back on	Uniaxial number match, 65535 is invalid
<input type="checkbox"/> Configure axi...	SFD48004	00000	00000	INT32U	Power back on	Uniaxial number match, 65535 is invalid
<input type="checkbox"/> Configure axi...	SFD48005	65535	65535	INT16U	Power back on	Uniaxial number match, 65535 is invalid
<input type="checkbox"/> Configure axi...	SFD48006	65535	65535	INT16U	Power back on	Uniaxial number match, 65535 is invalid
<input type="checkbox"/> Axis group er...	SFD48007	Is not enabled	Is not enabled	ENUM	Power back on	
<input type="checkbox"/> Stop mode	SFD48008	Given to stop	Given to stop	ENUM	Power back on	0: Given stop, the given position is unchanged when triggering emergency stop; 1: The feedback stops. When the stop is triggered, the given value steps to the feedback.

At present, the kinematics type only supports XYZ. If the XY type is required, the axis type SFD8000 + 300*N of the single axis corresponding to the Z axis can be modified to a virtual axis).

⑨ after configuration, enable each axis of the axis group through A_PWR. After each axis in the axis group is enabled, enable the axis group through G_PWR. After the axis group is enabled, the axis group commands can be executed. During the operation of the axis group, the state of the axis group can be monitored through D46000+300*N (single word), the current given position of the axis group can be monitored through D46044~D46064+300*N (double precision), the linear speed of the axis group can be monitored through D46116+300*N (double precision), and the current feedback position of the axis group can be monitored through D46140~D46160+300*N (double precision).

The ladder diagram:

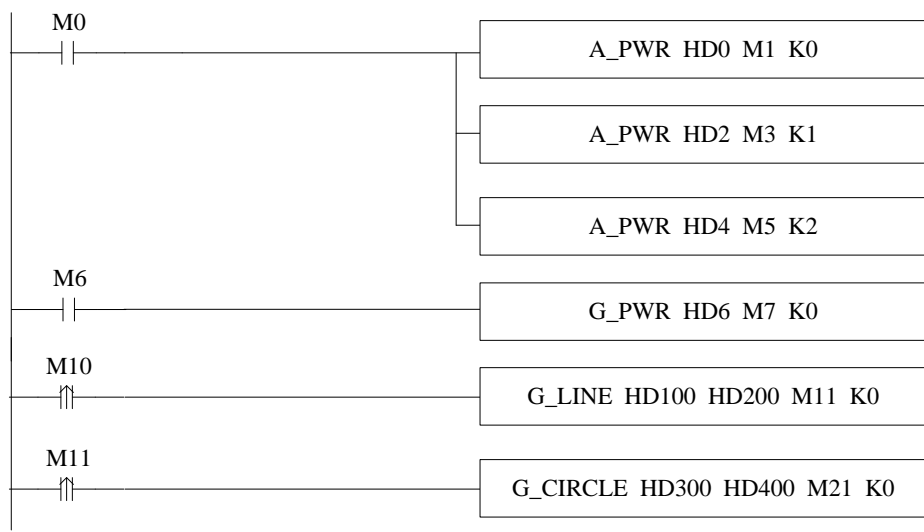

The command configuration:

G_LINEInstruction parameter configuration

Input parameter: HD100 Output parameter: HD200 Status parameter: M11
 Effective shaft group no: K0

Name	Addr	Online value	Offline value	Data type	statement
Input parameter					
PosX	HD100	0	100000	FP64	Position X
PosY	HD104	0	150000	FP64	position Y
PosZ	HD108	0	0	FP64	position Z
PosA	HD112	0	0	FP64	position A
PosB	HD116	0	0	FP64	position B
PosC	HD120	0	0	FP64	position C
Vel	HD124	0	10000	FP64	speed
Acc	HD128	0	25000	FP64	The acceleration
Dec	HD132	0	25000	FP64	Reduce speed
Jerk	HD136	0	50000	FP64	With the acceleration
CoordinateSyst...	HD140	Basecoordinatesy...	Basecoordinatesy...	INT16U	Coordinate system
BufferMode	HD141	interrupt	interrupt	INT16U	The caching pattern
TransitionMode	HD142	0	0	INT16U	Transition mode
EndVel	HD144	0	0	FP64	end speed
TransitionVel	HD148	0	0	FP64	The transition speed
Output parameter					
ErCode	HD200	0		INT16U	Error code
Status parameter					

space usage : ID100-HD151,HD200-HD200,M11-M15, Write Ok Cancel

G_CIRCLEInstruction parameter configuration

Input parameter: HD300 Output parameter: HD400 Status parameter: M21
 Effective shaft group no: K0

Name	Addr	Online value	Offline value	Data type	statement
Input parameter					
Mode	HD300	Threepoints	Threepoints	INT16U	The circular arc model
PathSelected	HD301	Clockwise	Clockwise	INT16U	Path selection
AuxX	HD304	0	150000	FP64	Auxiliary position X
AuxY	HD308	0	130000	FP64	Auxiliary position Y
AuxZ	HD312	0	0	FP64	Auxiliary position Z
AuxA	HD316	0	0	FP64	Auxiliary position A
AuxB	HD320	0	0	FP64	Auxiliary position B
AuxC	HD324	0	0	FP64	Auxiliary position C
PosX	HD328	0	200000	FP64	Position X
PosY	HD332	0	0	FP64	position Y
PosZ	HD336	0	0	FP64	position Z
PosA	HD340	0	0	FP64	position A
PosB	HD344	0	0	FP64	position B
PosC	HD348	0	0	FP64	position C
Vel	HD352	0	10000	FP64	speed
Acc	HD356	0	25000	FP64	The acceleration
Dec	HD360	0	0	FP64	Reduce speed
Jerk	HD364	0	0	FP64	With the acceleration

space usage : ID300-HD379,HD400-HD400,M21-M25, Write Ok Cancel

The command is being executed:

寄存器	监控值	字长	进制	注释
D20000	8	单...1...		轴1状态
D20200	8	单...1...		轴2状态
D20400	8	单...1...		轴3状态
D46000	2	单...1...		轴组状态
D46044	83514.476...	双...1...		X轴给定位置
D46048	125271.71...	双...1...		Y轴给定位置
D46052	0	双...1...		Z轴给定位置
D46116	10000	双...1...		轴组线速度
D46140	83507	双...1...		X轴反馈位置
D46144	125102	双...1...		Y轴反馈位置
D46148	0	双...1...		Z轴反馈位置

At this time, the single axis state $D20000+200*N$ in the axis group is 8 (in the axis group), and the state D4600 of the axis group is 2 (in the axis group movement). Its running track is a straight line + arc (the completion flag M11 of the G_LINE command triggers the G_CIRCLE command), the end point of the straight line is (10000,150000,0), the end point of the arc is (200000,0,0), and the arc passes through the auxiliary point (150000, 130000,0).

The motion trajectory diagram is as follows:

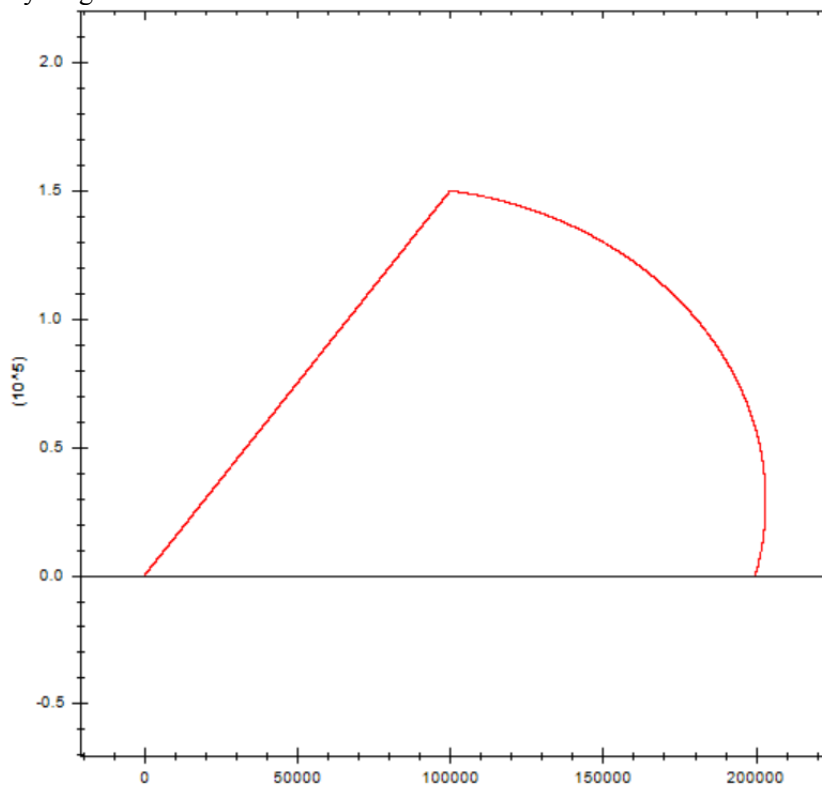

6-3. CAM function application

Take Xinje DS5C servo as an example, perform the cam movement of the master-slave axis relationship as shown in the figure in non cyclic mode and cyclic mode respectively:

EtherCAT configuration is same to chapter 6-1 step ①~⑦.

⑧ Configure the CAM table:

The screenshot shows the 'CAM CAM' configuration window. At the top, there are input fields for 'Cam周期时间' (1), '初始速度' (400000), and '初始加速度' (0). Below these is a table with the following data:

主轴	从轴	Cam曲线	速度	加速度	跃度	相节距
0	0					
100000	200000	直线	400000	0	0	100
200000	0	直线	-400000	0	0	100

Below the table is a graph titled '主从关系图' (Master-Slave Relationship Graph). The x-axis is '主轴 (10^3)' (Main Axis) ranging from 0 to 250. The y-axis is '从轴 (10^4)' (Slave Axis) ranging from -0.5 to 2.5. The graph shows a red line forming a triangle with vertices at (0, 0), (100, 2.0), and (200, 0).

(after configuration of cam table, click download)

⑨ Enable the master-slave axis of the cam through A_PWR. Load the corresponding cam table through CAMTBLSEL. After successful loading, execute CAMIN command to bind the cam. After successful cam binding, run the cam main axis through single axis command, and the cam slave station will move according to the corresponding cam table. (the cam can be bound during the operation of the axis, the main axis will maintain the current motion, and the slave axis will stop the current motion and move the point corresponding to the cam table).

The ladder diagram:

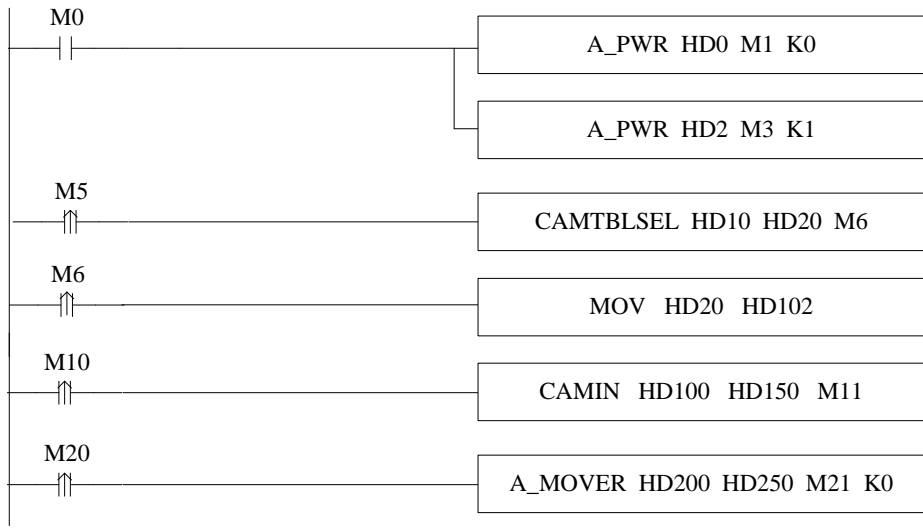

When the CAM is in non-cycle mode:
The command configuration is shown as below:

CAMTBLESELInstruction parameter configuration

Input parameter: HD10 Output parameter: HD20 Status parameter: M6

Name	Addr	Online value	Offline value	Data type	statement
Input parameter					
CamTbl	HD10	0	0	INT16S	To load the CAM table nu...
Periodic	HD11	donotuse	donotuse	INT16S	periodische Ausführung
MasterAbs	HD12	Relativemode	Relativemode	INT16S	The mode adopted by the ...
SlaverAbs	HD13	Relativemode	Relativemode	INT16S	The mode adopted from th...
Output parameter					
CamTblID	HD20	0		INT16S	Specifies the address of th...
ErrCode	HD21	0		INT16S	Specifies the address of th...
Status parameter					
Done	M6	False		BIT	Specify completion mark
Busy	M7	False		BIT	Specifies the executing flag
Err	M8	False		BIT	The specified error

space usage : ID10-HD13,HD20-HD21,M6-M8

Write Ok Cancel

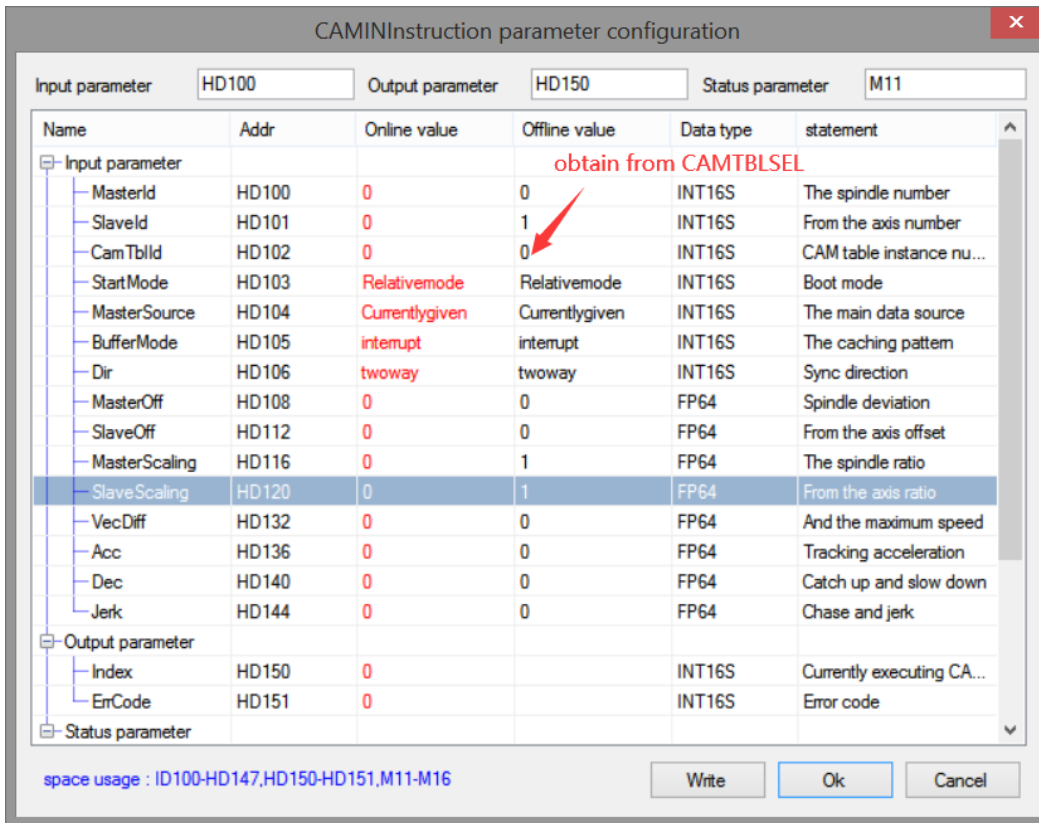

The cam table instance number parameter of CAMIN command is obtained by executing CAMTBLSEL command. After the parameter setting is completed, execute the CAMIN command. After the CAMIN command is successfully executed, its synchronization flag is set to on, indicating that the cam binding state has been entered at this time. The main axis movement is controlled by single axis command. The command configuration is as follows:

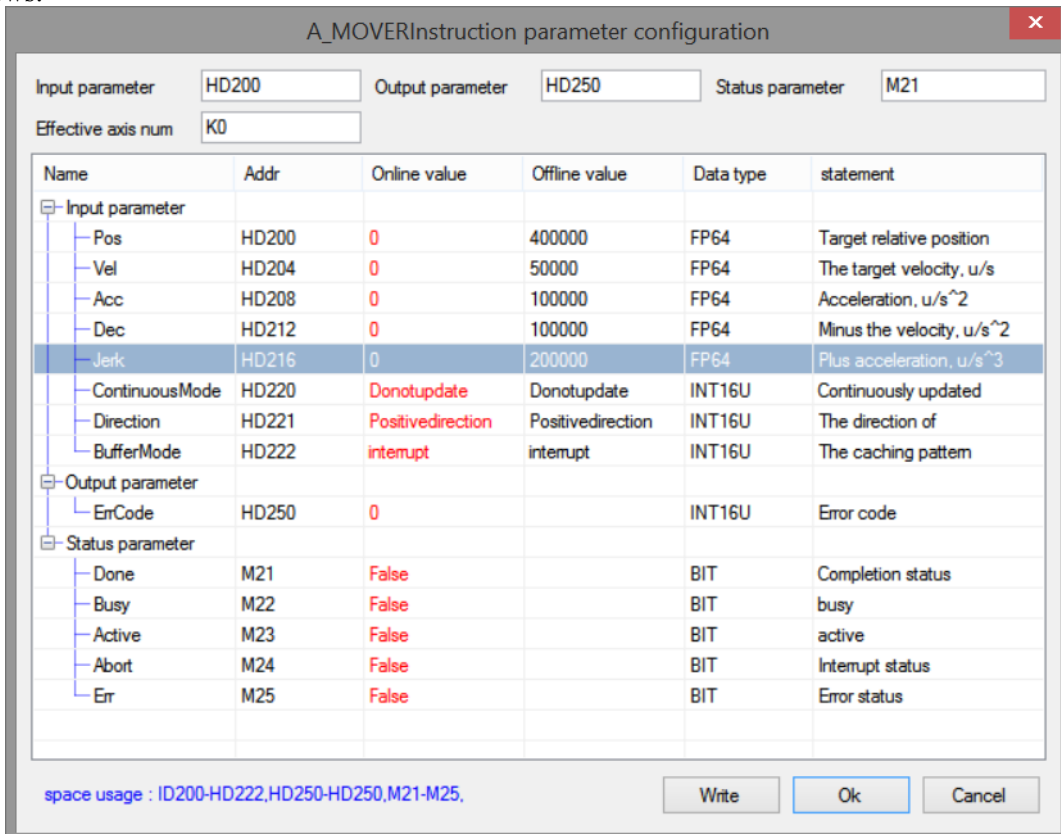

After the main axis runs, the given position is monitored through $D20016+200*N$, and the feedback position is monitored through $D20044+200*N$. The running track of its cam is shown in the figure below:

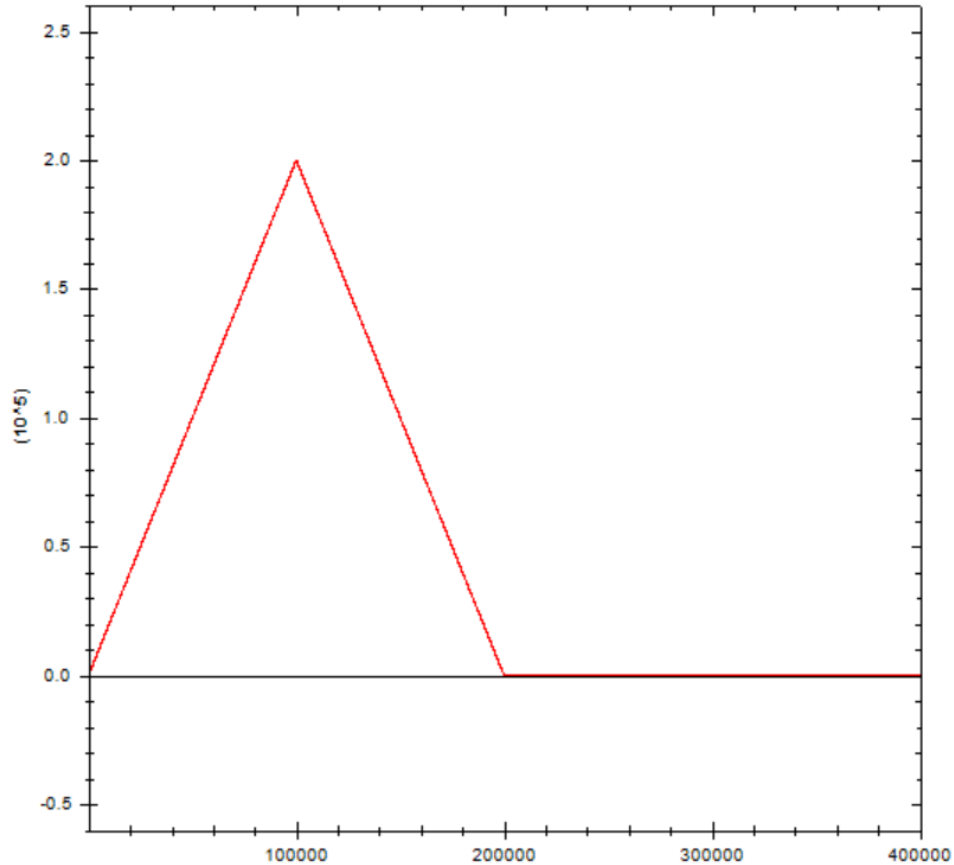

In the figure, axis X is the main axis position and axis Y is the slave axis position. When the main axis position is from 0 to 200000, the slave axis makes corresponding movement according to the point position of the cam table. When the main axis position is from 200000 to 400000, at this time, because the cam table is non-cyclic execution, the cam operation has ended and the slave axis position does not change.

When the CAM is in cyclic mode, the command configuration is shown as below:

CAMTBSELInstruction parameter configuration

Input parameter: HD10 Output parameter: HD20 Status parameter: M6

Name	Addr	Online value	Offline value	Data type	statement
Input parameter					
CamTbl	HD10	0	0	INT16S	To load the CAM table nu...
Periodic	HD11	donotuse	the	INT16S	periodische Ausführung
MasterAbs	HD12	Relativemode	Relativemode	INT16S	The mode adopted by the ...
SlaverAbs	HD13	Relativemode	Relativemode	INT16S	The mode adopted from th...
Output parameter					
CamTblID	HD20	0		INT16S	Specifies the address of th...
ErrCode	HD21	0		INT16S	Specifies the address of th...
Status parameter					
Done	M6	False		BIT	Specify completion mark
Busy	M7	False		BIT	Specifies the executing flag
Err	M8	False		BIT	The specified error

space usage : ID10-HD13,HD20-HD21,M6-M8

Write Ok Cancel

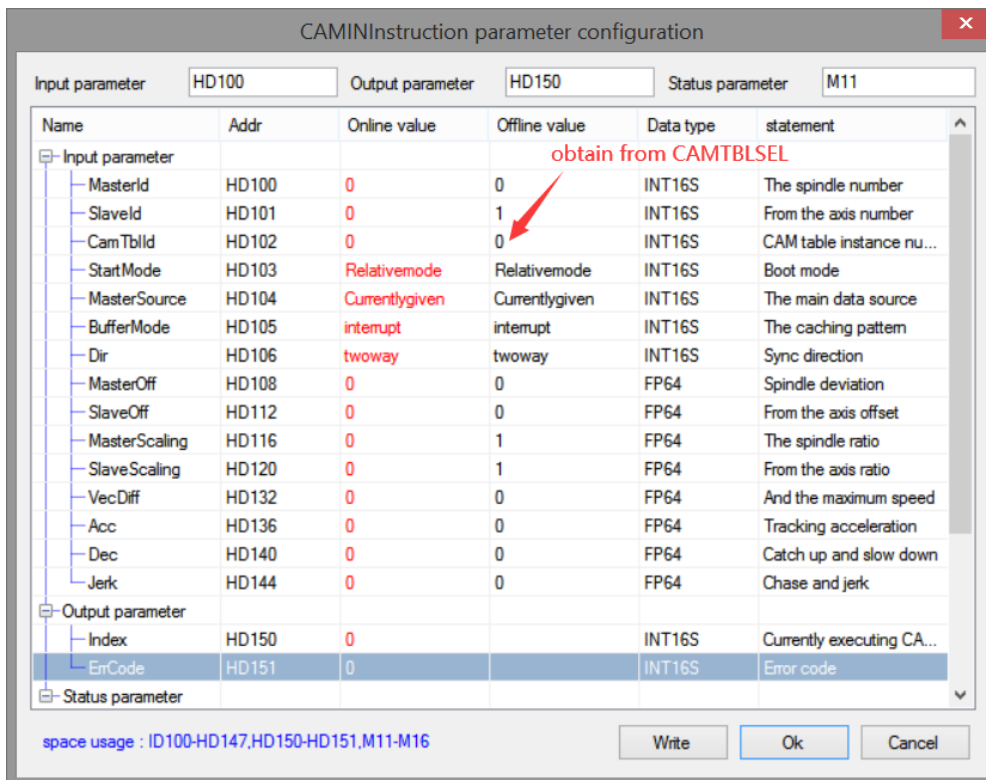

(In the loop mode, only the CAMTBLESEL instruction parameters changed, and the CAMIN instruction parameters are the same).

The cam table instance number parameter of CAMIN command is obtained by executing CAMTBLESEL command. After the parameter setting is completed, execute the CAMIN command. After the CAMIN command is successfully executed, its synchronization flag is set to on, indicating that the cam binding state has been entered at this time. The main axis movement is controlled by single axis command. The command configuration is as follows:

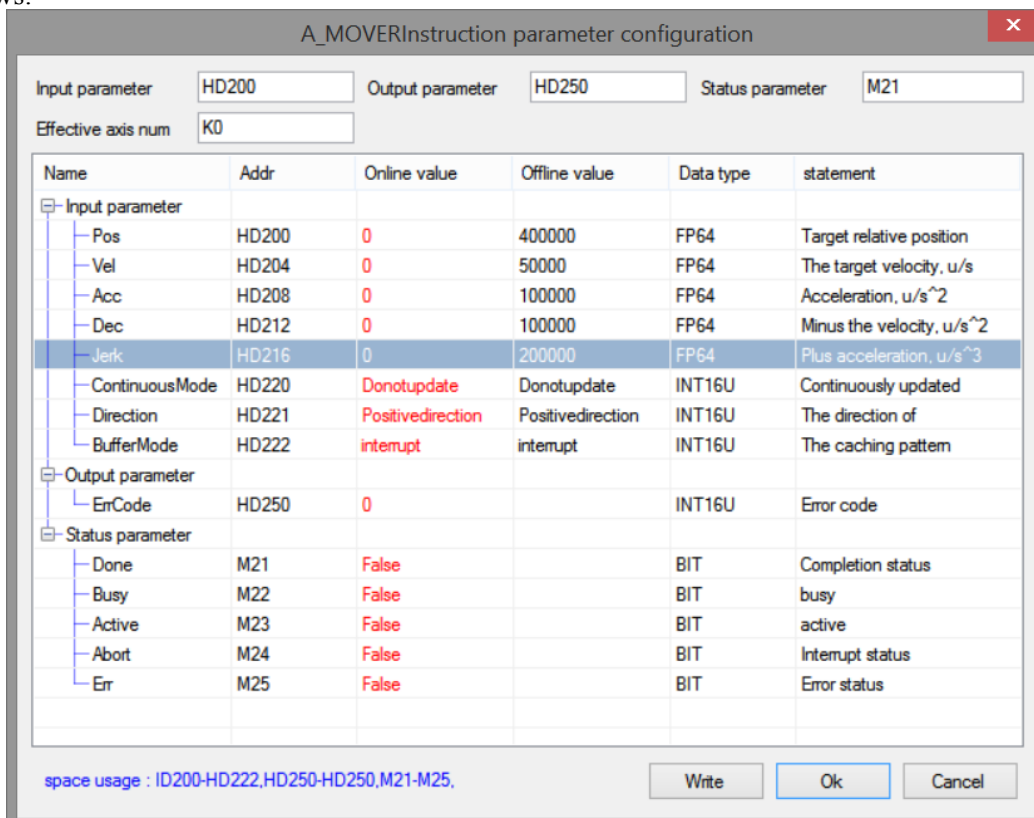

After the main axis runs, monitor the given position through $D20016+200*N$, monitor the feedback position through $D20044+200*N$. The CAM motion track is shown as below:

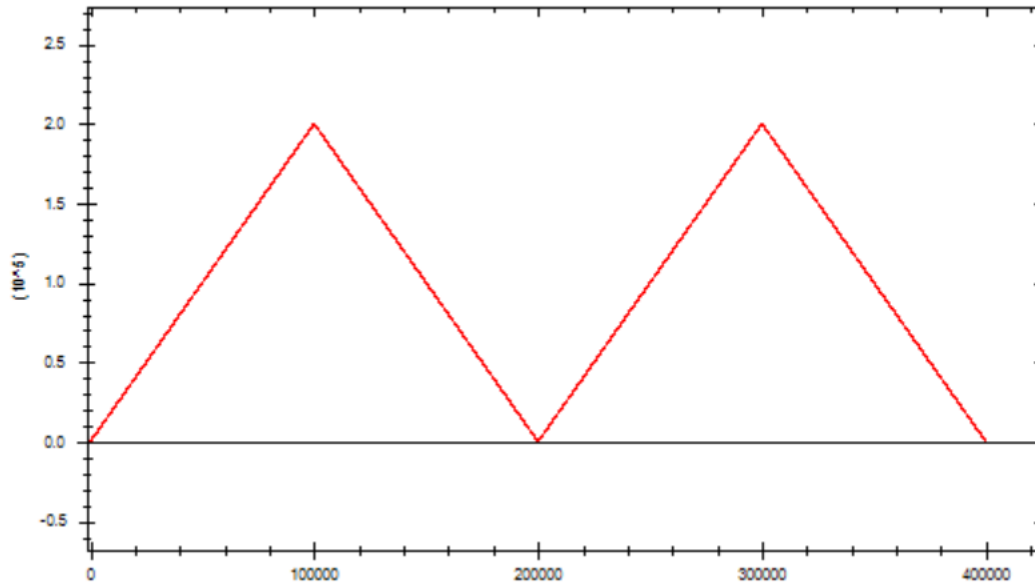

In the figure, axis X is the main axis position and axis Y is the slave axis position. When the main axis position is from 0 to 200000, the slave axis makes corresponding movement according to the point position of the cam table. When the main axis position is from 200000 to 400000, the slave axis makes a new cycle of cam movement.

If you want to know the master-slave axis position, speed, acceleration, connection track type and other information of a key point, you can read out the information of the point through CAMRD cam table reading command. The command configuration is as follows:

CAMRD指令参数配置

输入参数	MD1420	输出参数	D1420	状态参数	M1421
参数名	地址	在线值	高线值	类型	说明
输入参数					
CanTblId	MD1420	-5889	-5889	INT16S	凸轮表实例编号
PointId	MD1421	1	1	INT16S	凸轮表关键点序号
输出参数					
ErrCode	D1420	0		INT16S	指定错误码
Cnt	D1421	1		INT16S	读到的点数
MasterPos	D1422	100000		FP64	主轴位置
SlavePos	D1426	200000		FP64	从轴位置
Vec	D1430	400000		FP64	参考速度
Acc	D1434	0		FP64	参数加速度
Type	D1438	4		INT16S	衔接轨迹类型; 1: 三...
状态参数					
Done	M1421	True		BIT	指定完成标志
Busy	M1422	False		BIT	指定正在执行标志
Err	M1423	False		BIT	指定错误

占用空间: MD1420-MD1421, D1420-D1438, M1421-M1423

按钮: 写入, 确定, 取消

Annotations:
 - Red arrow pointing to PointId: obtain from CAMTBLSEL command
 - Red box around SlavePos, MasterPos, Vec: read the key point info

The cam table instance number is obtained through CAMTBLSEL command. The key point sequence number should start from 0, and 0 represents the first point (0,0) of the cam table.

The key information read out will be displayed in the output parameters.

If it is necessary to modify a key point in the cam table, it can be realized through the CAMWR cam table write command (will invalid when power failure). The command configuration is as follows:

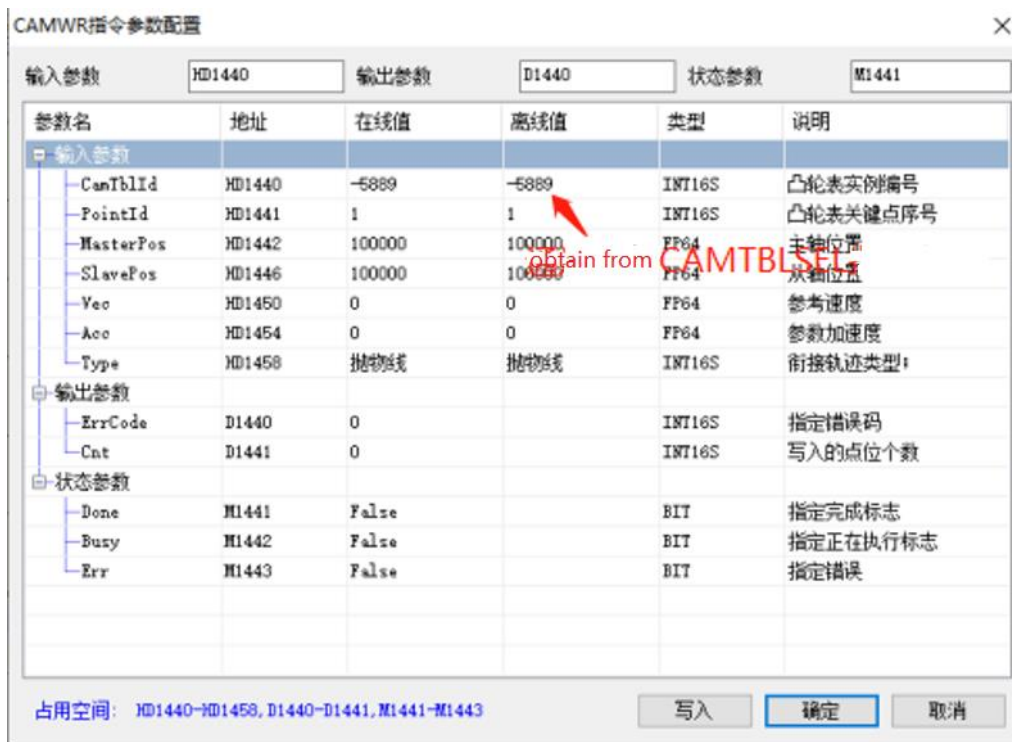

Among them, the cam table instance number is obtained through CAMTBLSEL, and the key point serial number shall start from 1, that is, the second key point (the first key point (0,0) cannot be modified). When the generated cam table instance is not needed, it can be unloaded through the CAMTBLDEL instruction to free the internal cache space. The instruction configuration is as follows:

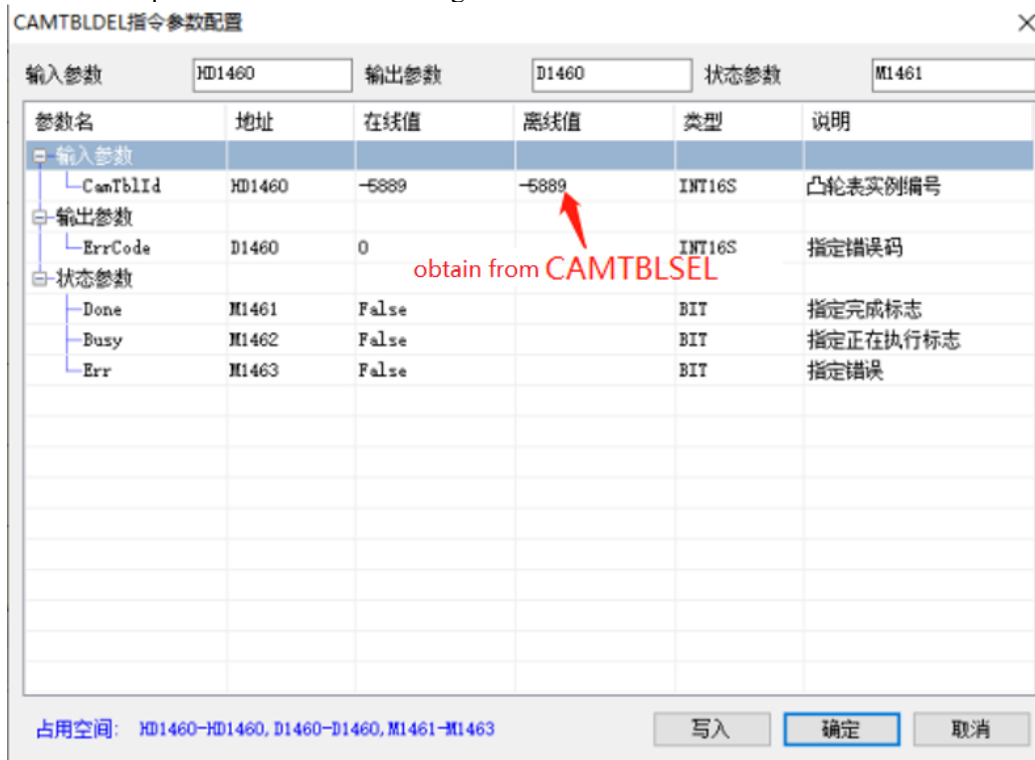

The cam table instance number is generated by the CANTBLSEL command. After the command is executed, the instance will be unloaded. If the instance number has been started by the CAMIN command, you need to execute the CAMOUT command to release the cam relationship, and then execute the unloading command. If A_STOP comman is used to stop the slave axis during the cam table motion process, you can directly execute the unloading command to unload the instance number without executing the CAMOUT command. When you need to add a key point to the cam table, you can use the CAMPOINTADD key point addition command. The command configuration is shown in the following figure:

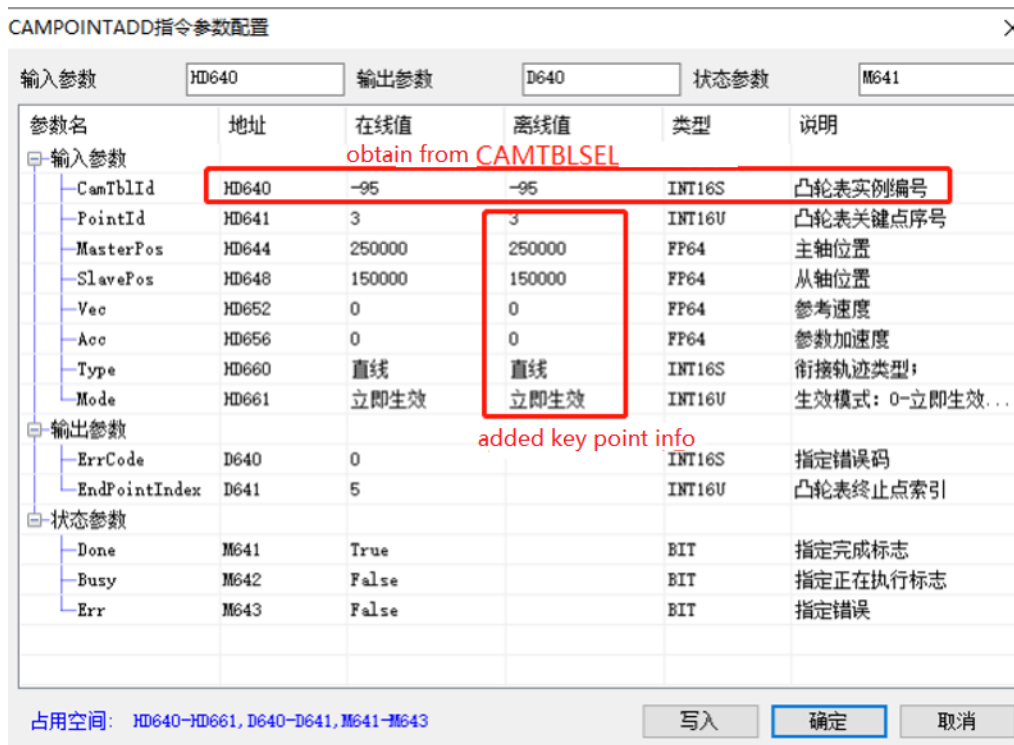

After the main axis runs, the cam master-slave relationship is as shown in the following figure:

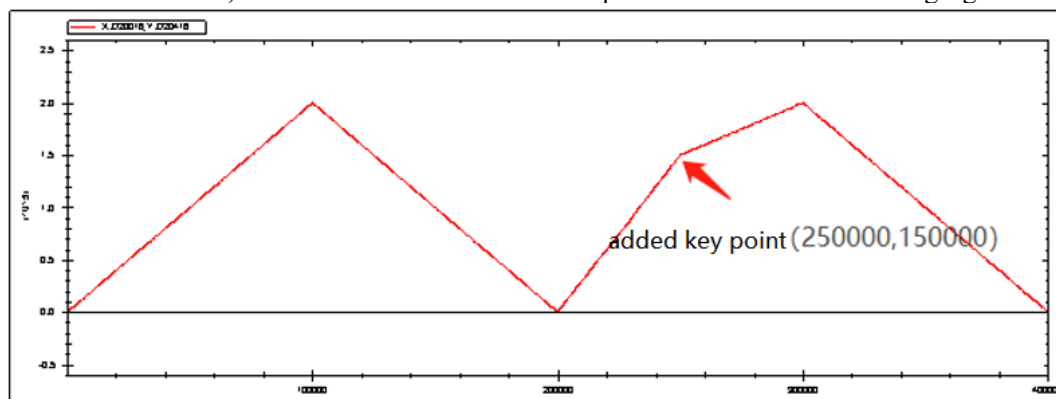

If a point in the cam table needs to be deleted, it can be realized through the CAMPOINTDEL key point deletion command. The command parameter configuration is shown in the following figure:

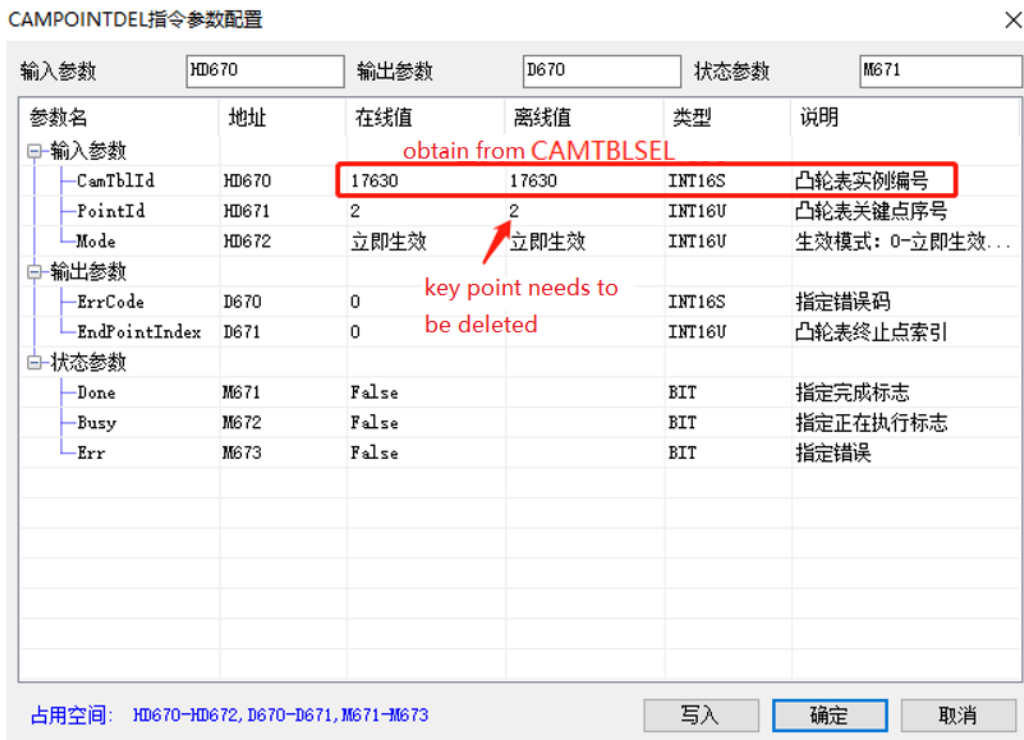

After the main axis runs, the cam master-slave relationship is as shown in the following figure:

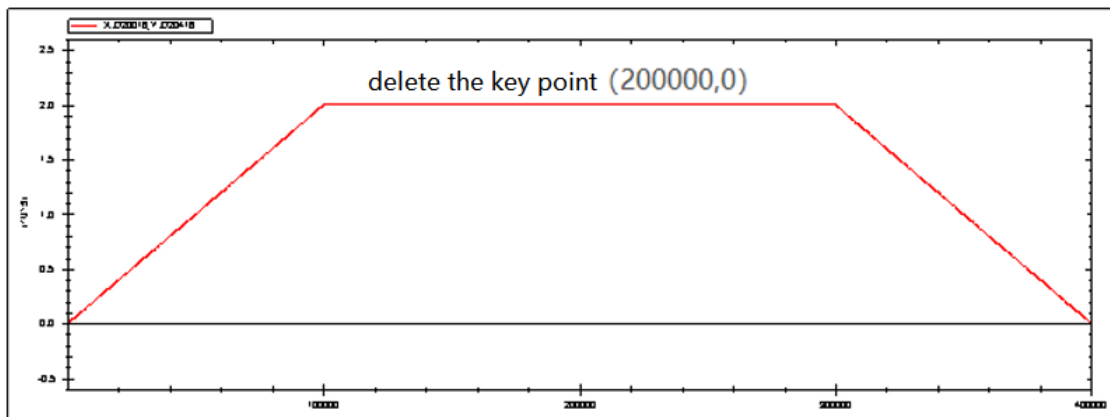

6-4. Pulse channel application

Operation steps of pulse output function.

(1) Modify the command channel to pulse in axis configuration-basic configuration.

Basic configuration		Probe configuration	Limit the configuration	Performance configuration	Detection and alarm configuration	Return to origin configuration	Pulse co
Parameter names	address	Offline values	Online value	type	Parameter effec...	instructions	
<input type="checkbox"/> Shaft type	SFD8000	Real axis	Real axis	ENUM	Power back on		
<input type="checkbox"/> Command cha...	SFD8001	pulse	pulse	ENUM	Power back on	Communication mode between controller and se	
<input type="checkbox"/> From the start...	SFD8002	0	0	INT16U	Power back on	Slave function mapping number corresponds	
<input type="checkbox"/> unit	SFD8003	pulse	pulse	ENUM	Power back on		
<input type="checkbox"/> Number of pul...	SFD8004	131072	131072	INT32U	Power back on	The number of feedback pulses in one rotation f	
<input type="checkbox"/> Encoder input...	SFD8006	0	0	INT16U	Power back on	High speed counting terminal	
<input type="checkbox"/> Gantry mode	SFD8007	Is not enabled	Is not enabled	ENUM	Power back on	If it is a slave shaft of gantry structure, when th	
<input type="checkbox"/> The amount o...	SFD8008	131072	131072	FP64	Power back on		
<input type="checkbox"/> Start reduction...	SFD8012	Is not enabled	Is not enabled	ENUM	Power back on		
<input type="checkbox"/> Side coefficie...	SFD8014	0	0	INT32U	Power back on		
<input type="checkbox"/> Side coefficie...	SFD8016	0	0	INT32U	Power back on		
<input type="checkbox"/> Direction of m...	SFD8018	Do not reverse	Do not reverse	ENUM	Power back on	0: Forward rotation of the motor in the direction	
<input type="checkbox"/> Position instr...	SFD8019	0	0	INT16U	Power back on	Unit: ms	
<input type="checkbox"/> Count type	SFD8020	A straight line	A straight line	ENUM	Power back on	Straight line: linear axis. If the soft limit is enable	
<input type="checkbox"/> Upper limit of ...	SFD8024	0	0	FP64	Power back on	Axis effective	
<input type="checkbox"/> Lower limit of ...	SFD8028	0	0	FP64	Power back on	Axis effective	
<input type="checkbox"/> Back gap com...	SFD8032	0	0	FP64	Power back on		
<input type="checkbox"/> Stop mode	SFD8036	Given to stop	Given to stop	ENUM	Power back on	0: Given stop, the given position is unchanged w	

(2) Set the pulse port and pulse direction port in axis configuration-probe configuration. Pulse port range is [0,3], direction port range is [0,7],[10,17],[20,27].

Basic configuration		Probe configuration	Limit the configuration	Performance configuration	Detection and alarm configuration	Return to origin configuration	Pulse configuration	A closed-loop configuration
Parameter names	address	Offline values	Online value	type	Parameter effec...	instructions		
<input type="checkbox"/> Pulse port	SFD8200	0	0	INT16U	Power back on	Y端子 (八进制)		
<input type="checkbox"/> Pulse directio...	SFD8201	4	4	INT16U	Power back on	Y端子 (八进制)		
<input type="checkbox"/> Pulse terminal...	SFD8202	Polarity nonreve...	Polarity nonreve...	ENUM	Power back on	0: High level trigger 1: Low level trigger		
<input type="checkbox"/> Pulse directio...	SFD8203	Polarity nonreve...	Polarity nonreve...	ENUM	Power back on	0: High level trigger 1: Low level trigger		

(3) modify the servo parameter to normal pulse control type, please refer to servo manual.

(4) enable the servo by manual.

(5) execute other motion commands after enabled.

Note:

- (1) Pulse port range is [0,3], direction port range is [0,7], [10,17], [20,27].
- (2) When there are multiple pulse axes, the pulse and direction port configurations cannot conflict.
- (3) The command A_MODE, A_HOME, A_PROBE, A_CYCVEL, A_CYCTRQ cannot support pulse channel.
- (4) In the pulse channel, it needs to enable the servo by manual. A_PWR cannot enable the servo, but all the motion commands can be executed after A_PWR is executed.
- (5) Since the pulse channel cannot directly control the servo, A_RST command can only clear the error report of the master station, but cannot clear the servo alarm.
- (6) For the axis group function, the constituent axis of the shaft group must be the same channel, that is, all are pulse channels or bus channels, otherwise the axis group enable command will report an error.
- (7) The use of other commands is the same as that of EtherCAT axis.
- (8) PLC firmware version should be v3.7.1 and above.

6-5. Full closed-loop function application

In some applications, it is necessary to carry out high-precision position control according to the actual position of the equipment. The full closed-loop function is to form a position loop through servo feedback position or high-speed counting position to achieve the purpose of control.

Set the parameters (take effective after power on again)

Address	Definition	Data type	Unit	Initial value	Note
SFD8204+300*N	closed loop switch	ENUM		0	Closed loop switch 0: OFF 1: ON
SFD8205+300*N	Closed loop feedback data source type	ENUM		0	Closed loop position feedback source: 0: bus position feedback 1: high speed counting terminal. Set through SFD8006+300*N
SFD8206+300*N	Encoder equivalent	FP64	Equivalent unit	0	It only takes effect when the closed-loop position feedback source is high-speed counting. The encoder inputs the movement of each pulse. That is movement per turn (SFD8008 + 300*N)/encoder pulse number per turn. Eg. PLC sets the movement per turn is 10000, the closed-loop position feedback source is a grating ruler or encoder for counting, and the high-speed counting value of each turn of the motor is 2500. Then the encoder equivalent value is set to 4.
SFD8210+300*N	Proportional gain	FP64		0	Proportional gain of PID in full closed loop control
SFD8214+300*N	Integral gain	FP64	ms	0	Integral gain of PID in full closed loop control
SFD8218+300*N	Differential gain	FP64		0	Differential gain of PID in full closed loop control
SFD8222+300*N	Speed feedforward gain	FP64	0.1%	0	Full closed loop speed feedforward gain
SFD8226+300*N	Feedback speed feedforward gain	FP64	0.1%	0	Full closed loop speed feedback gain
SFD8230+300*N	Closed loop maximum position gain	FP64	Command unit	0	Error code 2018 is returned when the closed-loop position deviation exceeds this limit value. When set to 0, it does not take effect.
SFD8234+300*N	Speed forward looking filtering time	INT16U	ms	0	Full closed loop speed feedforward filtering time
SFD8235+300*N	Feedback velocity filtering time	INT16U	ms	0	Full closed loop speed feedback filtering time
SFD8236+300*N	2 degree free alpha	FP64		0	Full closed loop 2 free degree alpha. Range 0~1, When the setting value is 0, no instruction

Address	Definition	Data type	Unit	Initial value	Note
					filtering is performed, and when the setting value is greater than 1, it is processed as 1.
SFD8240+300*N	2 degrees of freedom integration time	FP64	ms	0	Full closed loop 2 free degree integration time.

Dynamic parameters (take effective at once after modification. When the PLC runs again, it will write the SFD value of the corresponding parameter in the [set parameter])

Address	Definition	Data type	Unit	Initial value	Note
D20060+200*N	Proportional gain	FP64		0	Corresponding parameter SFD8210+300*N. The modification takes effect in real time.
D20064+200*N	Integral gain	FP64	ms	0	Corresponding parameter SFD8214+300*N. The modification takes effect in real time.
D20068+200*N	Differential gain	FP64		0	Corresponding parameter SFD8218+300*N. The modification takes effect in real time.
D20072+200*N	Speed feedforward gain	FP64	0.1%	0	Corresponding parameter SFD8222+300*N. The modification takes effect in real time.
D20076+200*N	Speed feedback gain	FP64	0.1%	0	Corresponding parameter SFD8226+300*N. The modification takes effect in real time.
D20080+200*N	External speed feedforward value	FP64	Command unit	0	Full closed loop external speed feedforward value.
D20084+200*N	2 free degree alpha	FP64		0	Corresponding parameter SFD8236+300*N. The modification takes effect in real time. The range is 0 ~ 1. When the setting value is 0, instruction filtering is not performed. When the setting value is greater than 1, it is processed as 1.
D20088+200*N	2 degree of freedom integration time	FP64	ms	0	Corresponding parameter SFD8240+300*N. The modification takes effect in real time.

Full closed loop control model

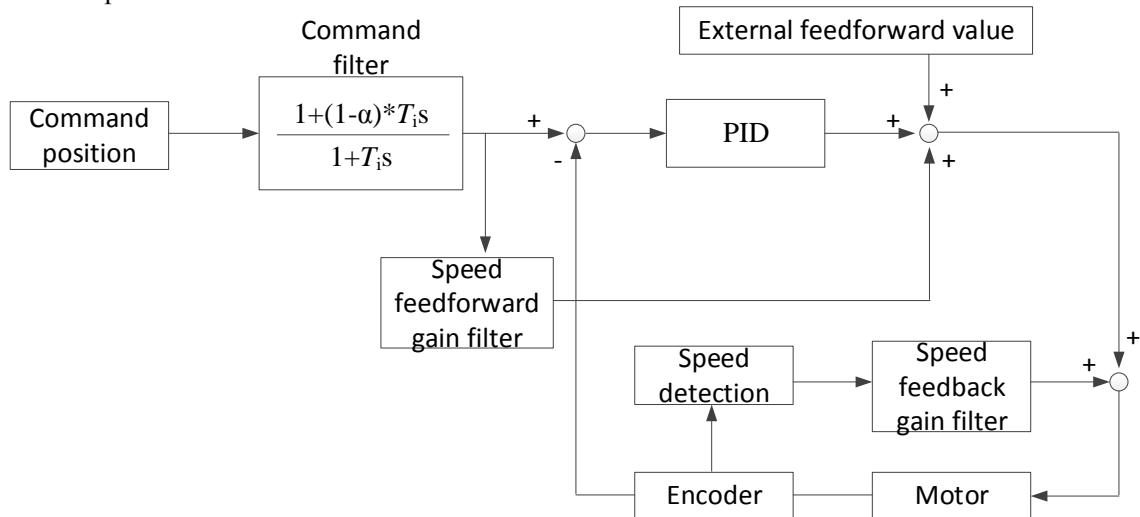

Usage and precautions:

- The full closed loop mode needs to operate in CSV mode. After the full closed loop mode is ON, it needs to switch to CSV mode through A_MODE command. After the full closed loop is ON, the command of the original CSP mode can be used in CSV mode. (instructions other than A_HOME, A_CYCVEL, A_CYCTRQ)
- When the closed-loop position feedback source SFD8205 + 300*N is set to 0, the full closed-loop takes the servo feedback position and feedback speed as the closed-loop input, and the full closed-loop position value is obtained through operation. See [full closed-loop control model] for the operation process.
- When the closed loop position feedback source SFD8205+300*N is set to 1, it needs to set the encoder input terminal SFD8006+300*N, encoder equivalent value SFD8206+300*N, closed loop takes high speed counting as closed loop input, and gets the closed loop position value through operation, the operation process refers to [full closed loop control model].
- After the full closed loop is on, the gain of the full closed loop can be adjusted in real time through [dynamic parameters]. When PLC is powered on again, the value in [set parameters] will be written into the register corresponding to [dynamic parameters].
- The higher the gain, the smaller the difference between the given position and the feedback. However, excessive gain will cause motor vibration. At this time, the gain value should be appropriately reduced.
- When using high-speed counting as the closed-loop position feedback source, please ensure that the mechanical principle meets the conditions of full closed-loop (whether the grating ruler or encoder synchronizes the current axis correctly, and whether the encoder equivalent value is set correctly).
- PLC firmware version is v3.7.1 and above.

7. Bus motion control function choice

7-1. H motion/C motion

C motion (simple motion control function) / H motion (practical motion control function).

All parameters and instructions in this manual need to be used under H motion. Please refer to <EtherCAT motion control user manual> for relevant instructions of C motion. The motion control function can be selected by modifying the parameter SFD811 (see section 5-1-3 for the modification method) or by software configuration. After the software configuration is modified, SFD811 will be automatically modified to the corresponding motion control function when downloading the program.

7-2. Software configuration

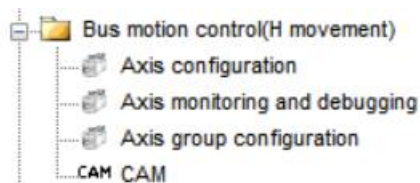

Right click [bus motion control] can select [enable C motion].

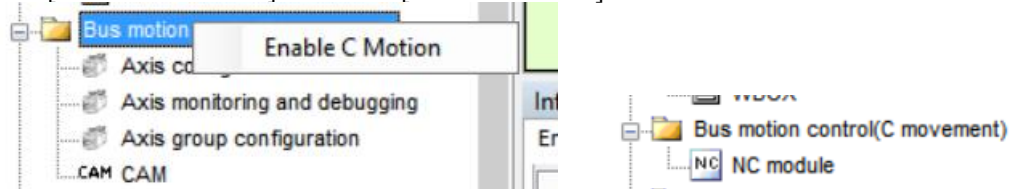

When selecting H motion, the project bar shows [axis configuration], [axis monitoring and debugging], [axis group configuration]. When selecting C motion, it shows [NC module].

Note:

When H motion or C motion is enabled, the download program will automatically modify the parameter SFD811 to the value of the corresponding motion control function. If SFD811 is manually changed to 0, a prompt will appear when opening the H motion configuration interface, as shown in the following information: current C motion, axis configuration is invalid. At this time, set SFD811 to 1, or enable the H motion, download program to use the axis configuration function.

8. Motion control configuration interface

8-1. Axis configuration

Enable the H motion to use the axis configuration.

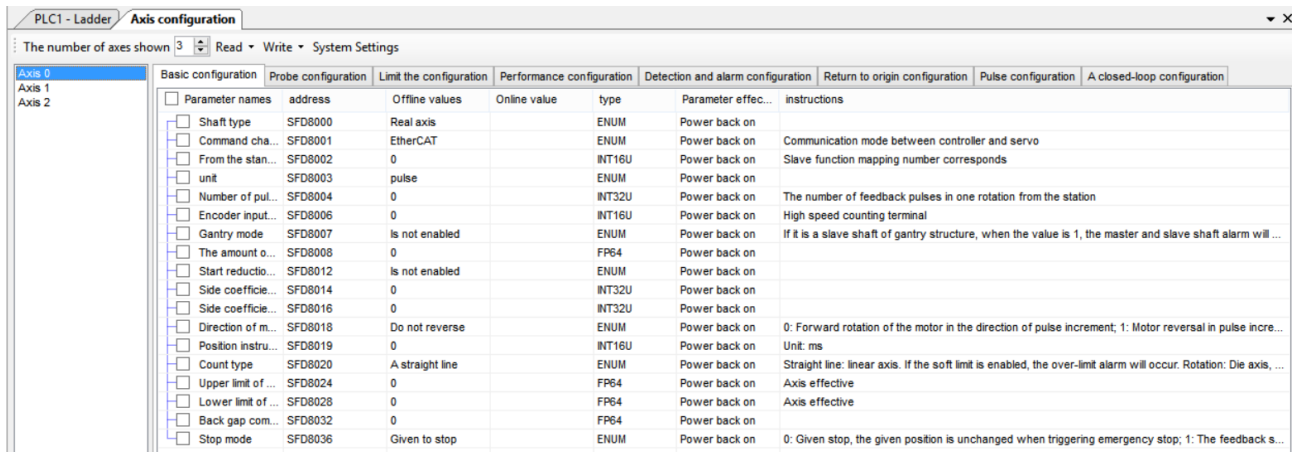
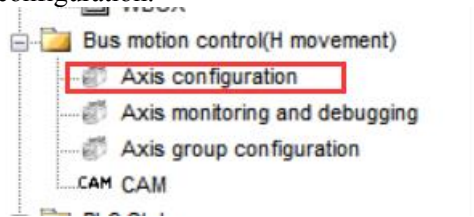

The main interface:

① [the number of axes shown]

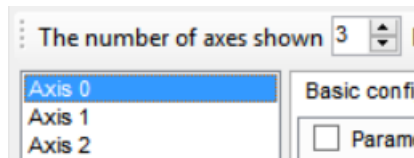

The setting of [the number of axes shown] determines the number of axes in the configuration bar. It has nothing to do with the actual number of connected axes and is only for display. Select the corresponding axis number to configure the axis related parameters.

② [read]

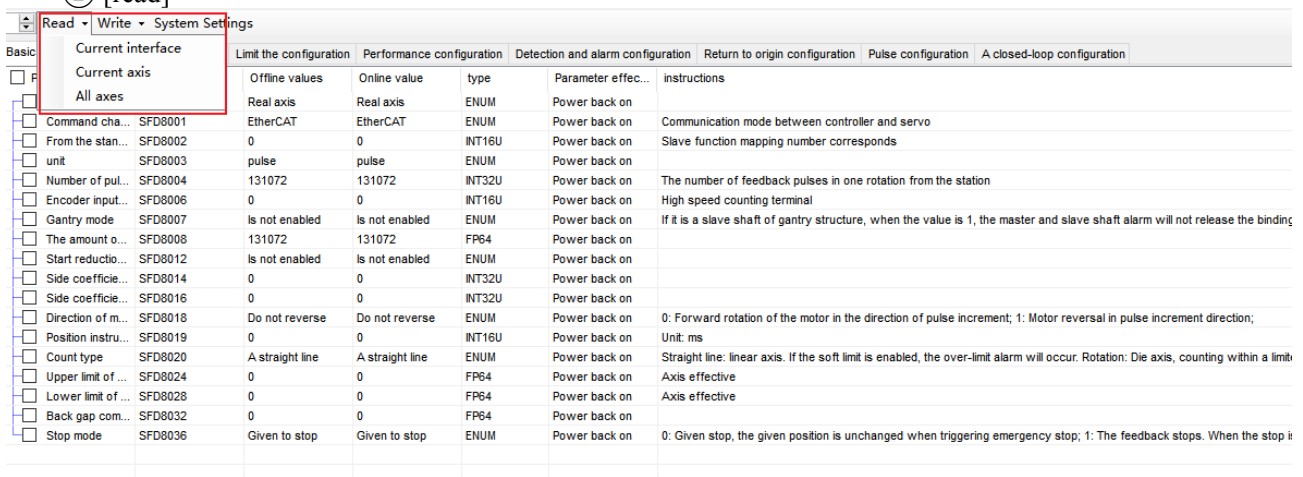

Click [read] to read the parameters.

[read]-[current interface]: read the parameters in the current interface

[read]-[current axis]: read the parameters of the current selected axis

[read]-[all axes]: read the parameters of all the axes

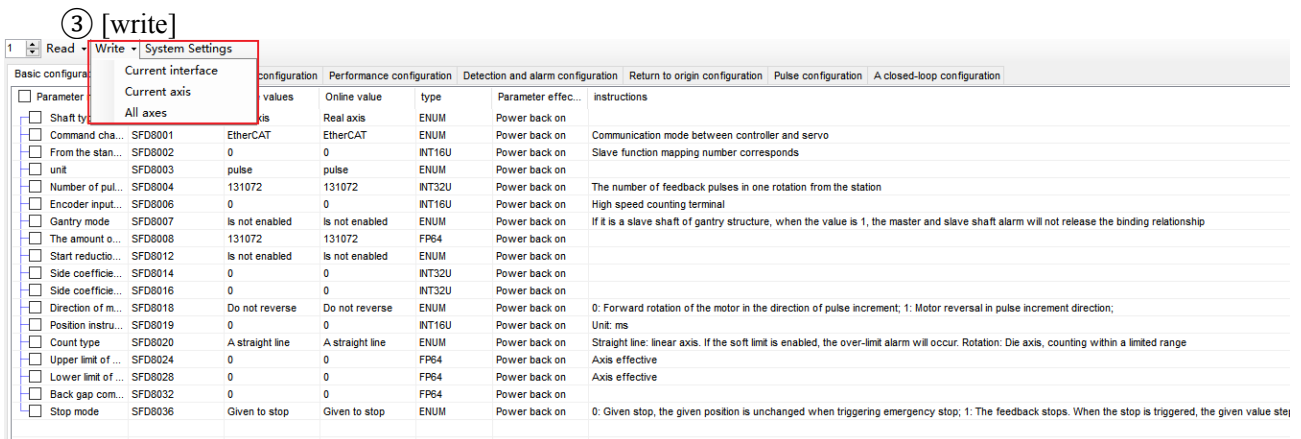

Click [write] to write in the parameters.

[write]-[current interface]: write the selected parameters in the current interface, it will automatically select the parameter when modify the offline value of the parameter.

[write]-[current axis]: write all the parameters of the current axis, only write in the selected parameters. It will automatically select the parameter when modify the offline value of the parameter.

[write]-[all axes]: write in the parameters of all the axes whatever selected or not.

④ [system settings]

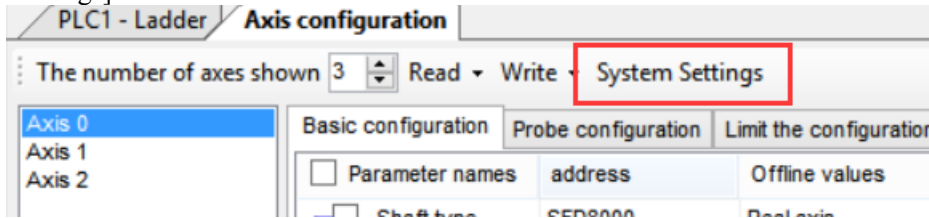

Click the [system settings] to show below interface:



[number of control shaft]: it is SFD810, refer to chapter 5-1-3 (the offline value is the setting value in [the number of axes shown], the online value is the actual value in current register).

[axis bit status start address]: it is SFD814, refer to chapter 5-1-3 (offline default value is 0, the online value is the actual value in current register).

[axis word status start address]: it is SFD816, refer to chapter 5-1-3 (offline default value is 0, the online value is the actual value in current register).

[axis word status preserves address]: not support at the moment.

⑤ Parameter interface

Parameter names	address	Offline values	Online value	type	Parameter effec...	instructions
<input type="checkbox"/> Shaft type	SFD8000	Real axis		ENUM	Power back on	
<input type="checkbox"/> Command cha...	SFD8001	EtherCAT		ENUM	Power back on	Communication mode between controller and servo
<input type="checkbox"/> From the stan...	SFD8002	0		INT16U	Power back on	Slave function mapping number corresponds
<input type="checkbox"/> unit	SFD8003	pulse		ENUM	Power back on	
<input type="checkbox"/> Number of pul...	SFD8004	0		INT32U	Power back on	The number of feedback pulses in one rotation from the station
<input type="checkbox"/> Encoder input...	SFD8006	0		INT16U	Power back on	High speed counting terminal
<input type="checkbox"/> Gantry mode	SFD8007	Is not enabled		ENUM	Power back on	If it is a slave shaft of gantry structure, when the value is 1, the master and slave shaft alarm will ...
<input type="checkbox"/> The amount o...	SFD8008	0		FP64	Power back on	
<input type="checkbox"/> Start reductio...	SFD8012	Is not enabled		ENUM	Power back on	
<input type="checkbox"/> Side coeffic...	SFD8014	0		INT32U	Power back on	
<input type="checkbox"/> Side coeffic...	SFD8016	0		INT32U	Power back on	
<input type="checkbox"/> Direction of m...	SFD8018	Do not reverse		ENUM	Power back on	0: Forward rotation of the motor in the direction of pulse increment; 1: Motor reversal in pulse incre...
<input type="checkbox"/> Position instru...	SFD8019	0		INT16U	Power back on	Unit: ms
<input type="checkbox"/> Count type	SFD8020	A straight line		ENUM	Power back on	Straight line: linear axis. If the soft limit is enabled, the over-limit alarm will occur. Rotation: Die axis, ...
<input type="checkbox"/> Upper limit of ...	SFD8024	0		FP64	Power back on	Axis effective
<input type="checkbox"/> Lower limit of ...	SFD8028	0		FP64	Power back on	Axis effective
<input type="checkbox"/> Back gap com...	SFD8032	0		FP64	Power back on	
<input type="checkbox"/> Stop mode	SFD8036	Given to stop		ENUM	Power back on	0: Given stop, the given position is unchanged when triggering emergency stop; 1: The feedback s...

[Basic configuration]: corresponds to the register SFD8000+300*N~SFD8036+300*N, refer to chapter 5-1-3.

[Limit configuration]: corresponds to the register SFD8040+300*N~SFD8076+300*N, refer to chapter 5-1-3.

[Performance configuration]: corresponds to the register SFD8080+300*N~SFD8099+300*N, refer to chapter 5-1-3.

[Detection and alarm configuration]: corresponds to the register SFD8120+300*N~SFD8139+300*N, refer to chapter 5-1-3.

[Return to origin configuration]: not support at the moment.

[Pulse configuration]: not support at the moment.

[A closed-loop configuration]: not support at the moment.

(The parameters are modified in [offline value], click [write] to take effective, [online value] is the display value of corresponding registers which cannot be changed).

8-2. Axis monitor and debug

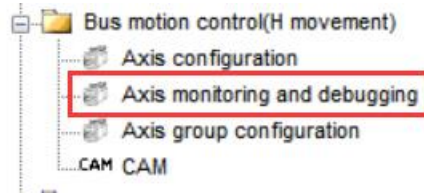

The interface is shown as below:

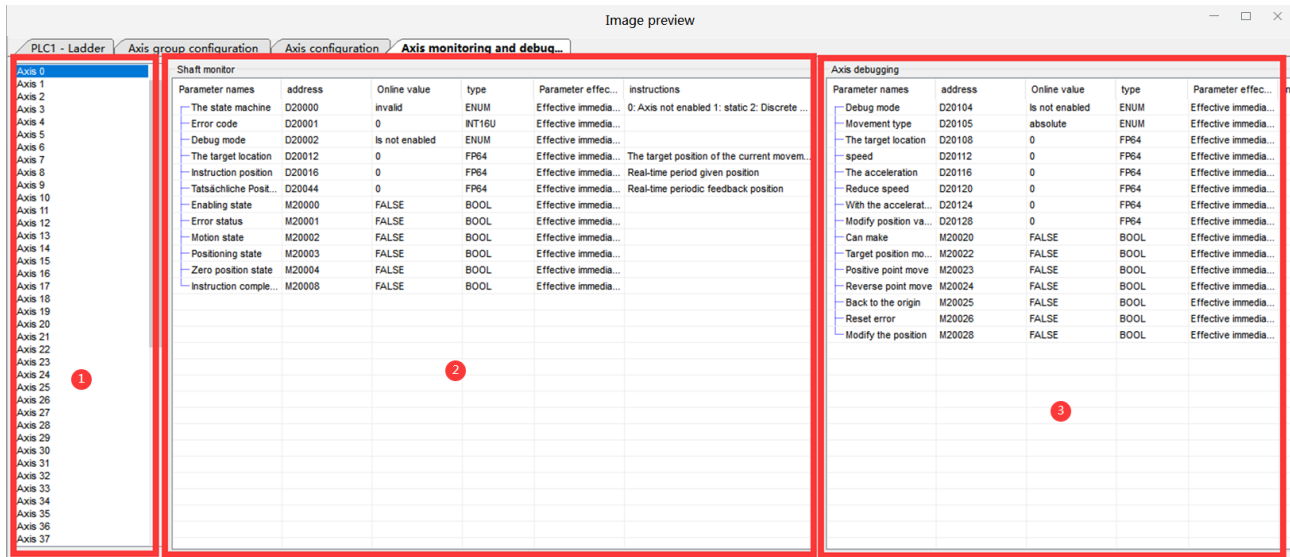

- ① Axis selection interface: click the axis number to monitor / debug the axis.
- ② Axis monitoring interface: monitors the status of the current axis, including state machine, error code, target position, command position, etc. The register / coil in this interface is only used for monitoring and cannot be modified.
- ③ Axis debugging interface: debugging the current axis is valid only when the debugging mode is enabled (directly enable on the interface or modify the corresponding register $D20104 + 200*N$). After the debugging mode is enabled, you can do the operation of enable, move to the target position, return to the origin and other actions through the registers and coils on the interface. (the homing is the same as the A_HOME command, and the Ethernet parameters 6098h, 6099h and 609Ah need to be set. See section 5-1-2-12 for details).

The differences of D20040, D20016, D20044:

D20040: encoder feedback value

D20016: The position that the axis should reach in each scan cycle after the command is executed.

D20044: The position feedback is obtained by conversion according to the set electronic gear ratio, movement per cycle, number of pulses per cycle and other parameters.

8-3. Axis group configuration

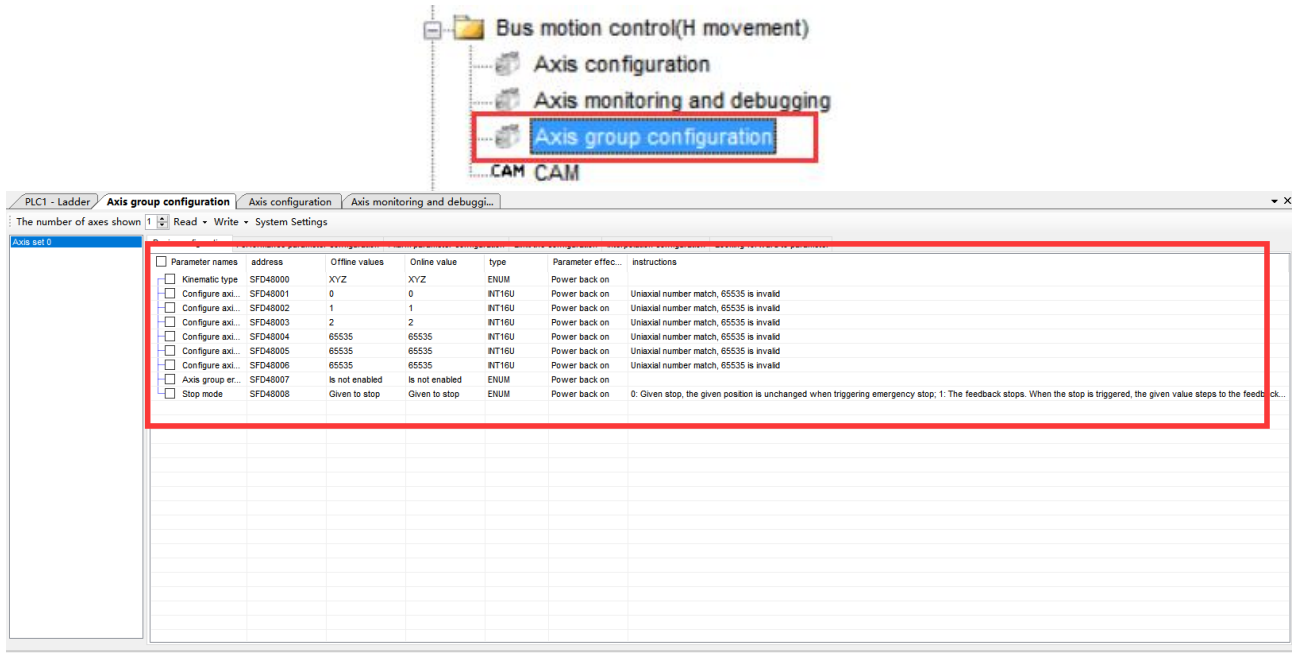

The main interface:

① [the number of axes shown]

The setting of the number of displayed axes determines the number of axis groups in the configuration bar. It has nothing to do with the number of actually configured axis groups. It is only for display. The number of actually configured axis groups is modified by SFD820. Select the corresponding axis group number to configure the relevant parameters of the axis group.

② [read]

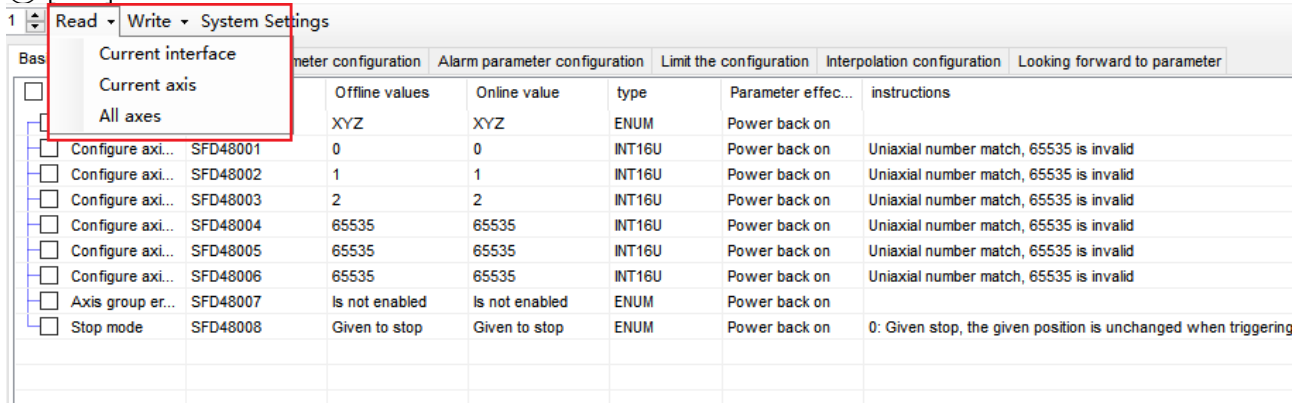

Click [read] to read the parameters.

[Read] – [current interface]: only the parameters of the current interface are read (the current interface refers to the main interface category currently displayed, as shown in the figure is the basic configuration interface).

[Read] – [current axis]: read all parameters of the currently selected axis group.

[Read] – [all axes]: read all parameters of all axis groups in the interface.

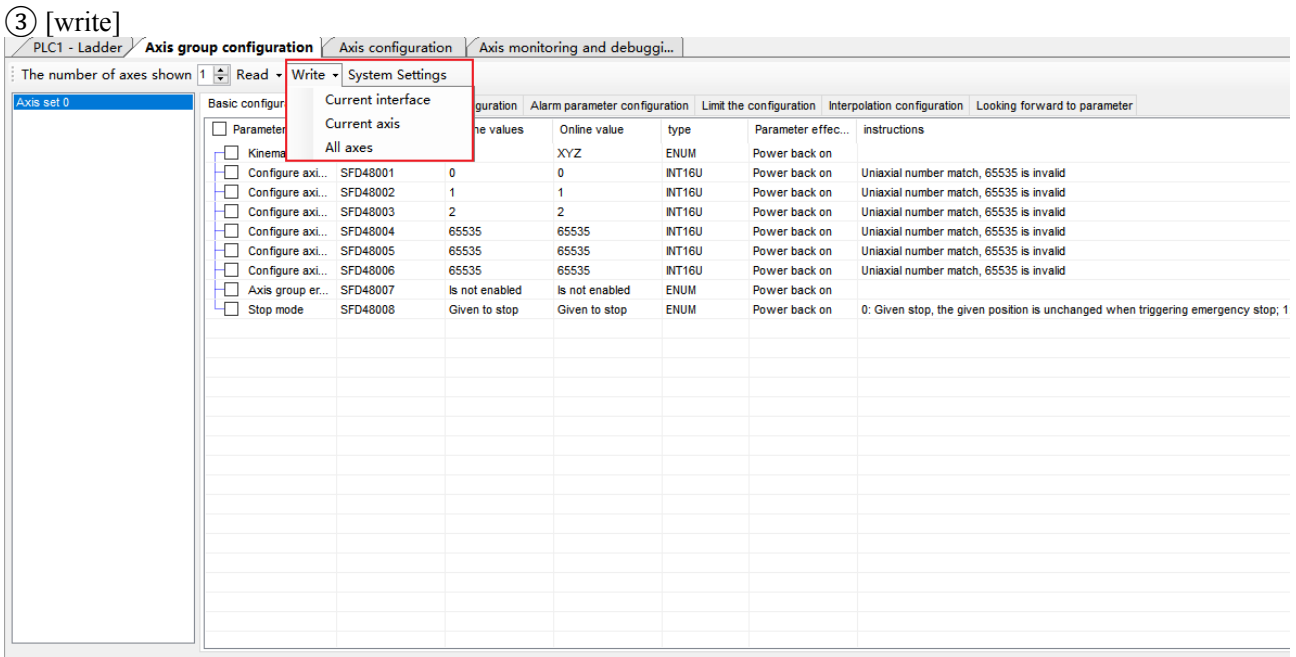

Click [write] to write parameters

[Write] – [current interface]: write only the parameters in the current interface and only the selected parameters. It will be selected automatically after modifying the offline value of the parameter. (the current interface only displays the main interface category, as shown in the figure is the basic configuration interface)

[Write] – [current axis]: write all the parameters of the current axis group. Only the selected parameters are written. After modifying the offline value of the parameter, it will be selected automatically.

[Write] – [all axes]: write all parameters of all axis groups in the interface, whether selected or not.

④ [system settings]

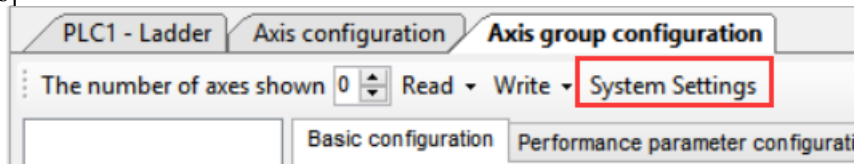

Click [system settings] to show below interface:

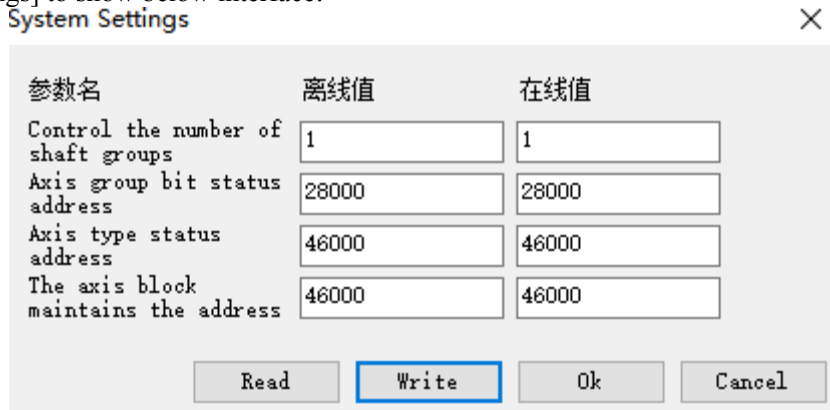

[Control the number of shaft groups]: it is SFD820, refer to chapter 5-2-3 (offline value is the set value in [the number of axes shown], the online value is the actual value of the current register).

[Axis group bit status address]: it is SFD824, refer to chapter 5-2-3 (the default offline value is 28000, the online value is the actual value of the current register).

[Axis type status address]: it is SFD826, refer to chapter 5-2-3 (the default offline value is 46000, the online value is the actual value of the current register).

[The axis block maintains the address]: not support at the moment.

⑤ Parameters interface

Basic configuration		Performance parameter configuration		Alarm parameter configuration		Limit the configuration		Interpolation configuration		Looking forward to parameter	
Parameter names	address	Offline values	Online value	type	Parameter effec...	instructions					
<input type="checkbox"/> Kinematic type	SFD48000			ENUM	Power back on						
<input type="checkbox"/> Configure axi...	SFD48001			INT16U	Power back on	Uniaxial number match, 65535 is invalid					
<input type="checkbox"/> Configure axi...	SFD48002			INT16U	Power back on	Uniaxial number match, 65535 is invalid					
<input type="checkbox"/> Configure axi...	SFD48003			INT16U	Power back on	Uniaxial number match, 65535 is invalid					
<input type="checkbox"/> Configure axi...	SFD48004			INT16U	Power back on	Uniaxial number match, 65535 is invalid					
<input type="checkbox"/> Configure axi...	SFD48005			INT16U	Power back on	Uniaxial number match, 65535 is invalid					
<input type="checkbox"/> Configure axi...	SFD48006			INT16U	Power back on	Uniaxial number match, 65535 is invalid					
<input type="checkbox"/> Axis group er...	SFD48007			ENUM	Power back on						
<input type="checkbox"/> Stop mode	SFD48008			ENUM	Power back on	0: Given stop, the given position is unchanged when triggering emergency stop; 1: The feedback s...					

[Basic configuration]: corresponds to the register SFD48000+300*N~SFD48008+300*N, refer to chapter 5-2-3.

[Performance parameter configuration]: corresponds to the register SFD48020+300*N~SFD48059+300*N, refer to chapter 5-2-3.

[Alarm parameter configuration]: corresponds to the register SFD48100+300*N~SFD48105+300*N, refer to chapter 5-2-3.

[Limit configuration]: corresponds to the register SFD48120+300*N~SFD48145+300*N, refer to chapter 5-2-3.

[Interpolation configuration]: not support at the moment.

[Looking forward parameters]: corresponds to the register SFD48232+300*N~SFD48280+300*N, refer to chapter 5-2-3.

(The parameters are modified in [offline value], click [write] to take effective, [online value] is the display value of corresponding registers which cannot be changed).

9. Oscilloscope function

9-1. Operating conditions of oscilloscope

The oscilloscope function can only be used when the EtherCAT slave is connected and the programming software is in the X-NET monitoring mode.

9-2. Open the oscilloscope

Click the oscilloscope icon as shown in the figure to open the oscilloscope interface.

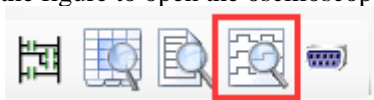

The interface is shown as below:

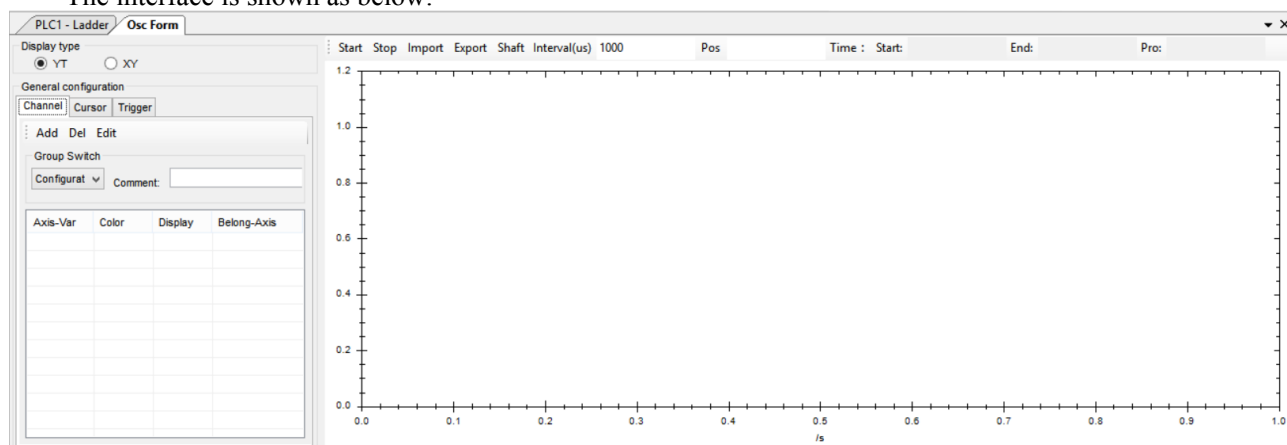

9-3. Oscilloscope main interface

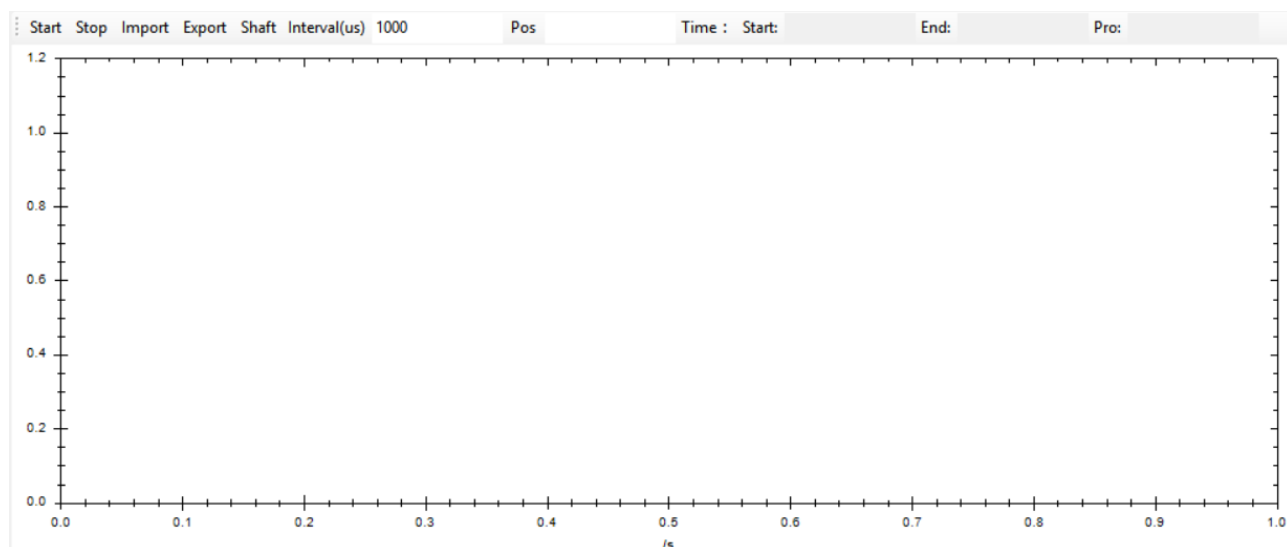

Parameter	Explanation
Start	The oscilloscope starts to work
Stop	Oscilloscope stops working
Import	Open saved oscilloscope data
Export	Save all the oscilloscope data (curve configuration, cursor, trigger, image data, oscilloscope working time, etc.) under the current situation

Shaft	Display different Y-axes of the same display area into different regions. Note: this function is valid only when the curve is configured with different axes; when there is only one axis, axis splitting cannot be realized. When the user configures different axes, multiple Y-axes are displayed. Only when there are more than one y-axis, the function of axis splitting can be realized.
Interval (us)	The time interval between the two sampling points, the unit is us (default is the value of the synchronization unit cycle in EtherCAT)
Pos	Locate a curve starting from one time or value
Time	Display start, end and oscilloscope working time

Interface operation instructions

Parameter	Explanation
Zoom in	Hold the left mouse button and drag to select the area to be enlarged. The default zooming method is to zoom in both horizontally and vertically (region magnification). Right click the menu displayed in the display area to modify the zoom mode (horizontal zoom in and vertical zoom in).
Zoom out	Right click the display area and click restore to original/restore to previous zoom in the display menu to zoom out
Drag	There are three ways to drag: ① hold the Ctrl + left button, the cursor changes to hand type and drag the image; ② press and hold the middle button (wheel) of the mouse to drag the image; ③ when the horizontal zoom and vertical zoom in the right-click menu are not selected (there is no zoom function at this time), press and hold the left mouse button to drag the image.

Right mouse button function:

Parameter	Explanation
Save chart	Save the image of the current interface in picture format
Export data	Save the image data in Excel format
Restore to original scale	Display the entire curve
Display node value	When the mouse moves to a node on the curve, the coordinate axis value of the node is displayed
Restore to previous scale	The image zoom out to the previous display scale and area
Scale horizontally	Zoom in / out X axis only
Zoom vertically	Zoom in / out Y axis only (region can be zoomed only if both horizontal and vertical scaling are selected)

Note: when the interface displays data for more than one minute, the data curve before one minute will be cleared, but the data still exists. Users need to click export data in the right-click menu to view all data.

9-4. Oscilloscope configuration interface

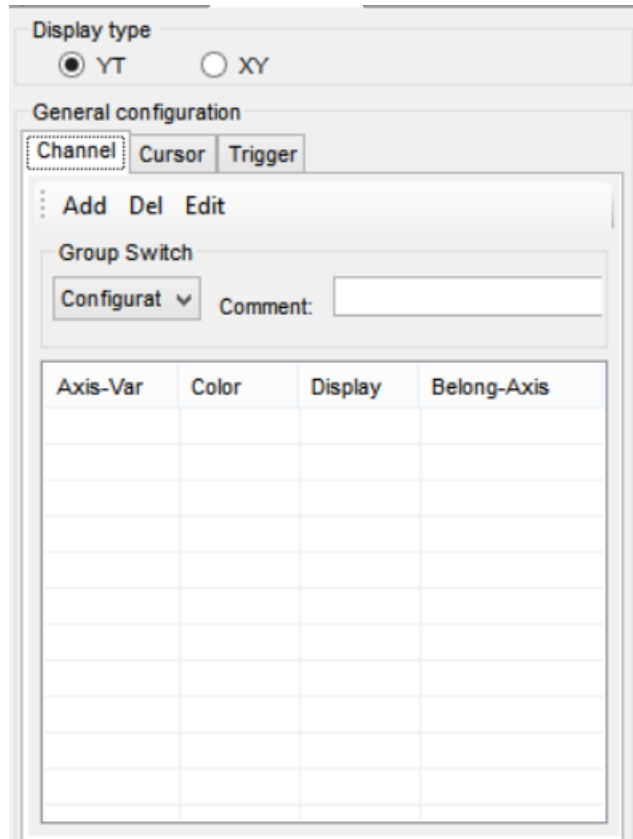

9-4-1. Oscilloscope type configuration

Parameter	Explanation
YT	Abscissa is time variable, ordinate is single register variable, only single register variable is needed to configure curve
XY	Abscissa and ordinate are both register variables. When configuring the curve, two register variables need to be configured

9-4-2. Axis variable configuration

Axis-Var	Color	Display	Belong-Axis

Parameter	Explanation
Add	Add the curve
Delete	Delete the curve
Edit	Edit curve properties

Note: when the oscilloscope starts to work, can not add or delete curves, only can edit curve attributes.

9-4-3. Register configuration

Click add to show the register configuration interface:

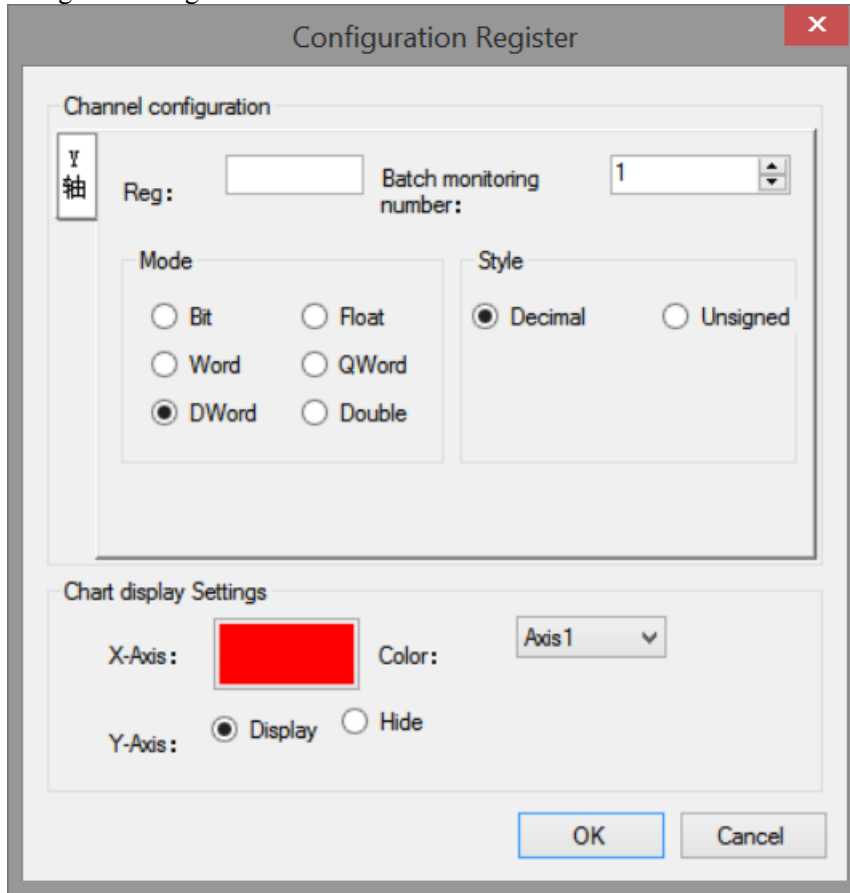

Parameter	Explanation
X axis	Register type (HD, D, SD) + register offset (number)+ register data type
Y axis	Register type (HD, D, SD) + register offset (number)+ register data type
Color	Curve display color (click the color block to modify the curve color)
Display	The curve displays on the oscilloscope display interface or not
Axis1	Which axis is the curve displayed on the oscilloscope display interface (for the realization of the axis splitting function)

Note:

- (1) When the oscilloscope type is YT, the [X-axis] cannot be configured, and the abscissa displays the time.
- (2) When the oscilloscope starts to work, it can only adjust the color, display and axis attribute of the curve, and the register of XY axis cannot be modified.

9-4-4. Cursor configuration

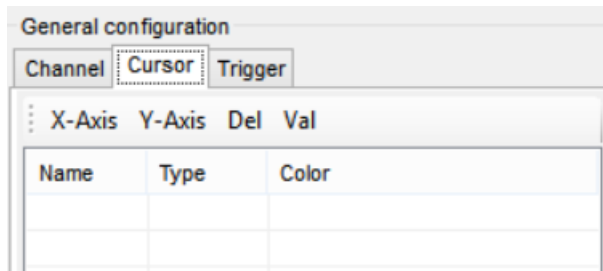

Parameter	Explanation
X axis	Add X-axis cursor (vertical cursor, perpendicular to X-axis)
Y axis	Add Y-axis cursor (horizontal cursor, perpendicular to Y-axis)
Delete	Delete the cursor
Value	Display cursor difference data

9-4-5. Difference interface

Click [value] to show below window:

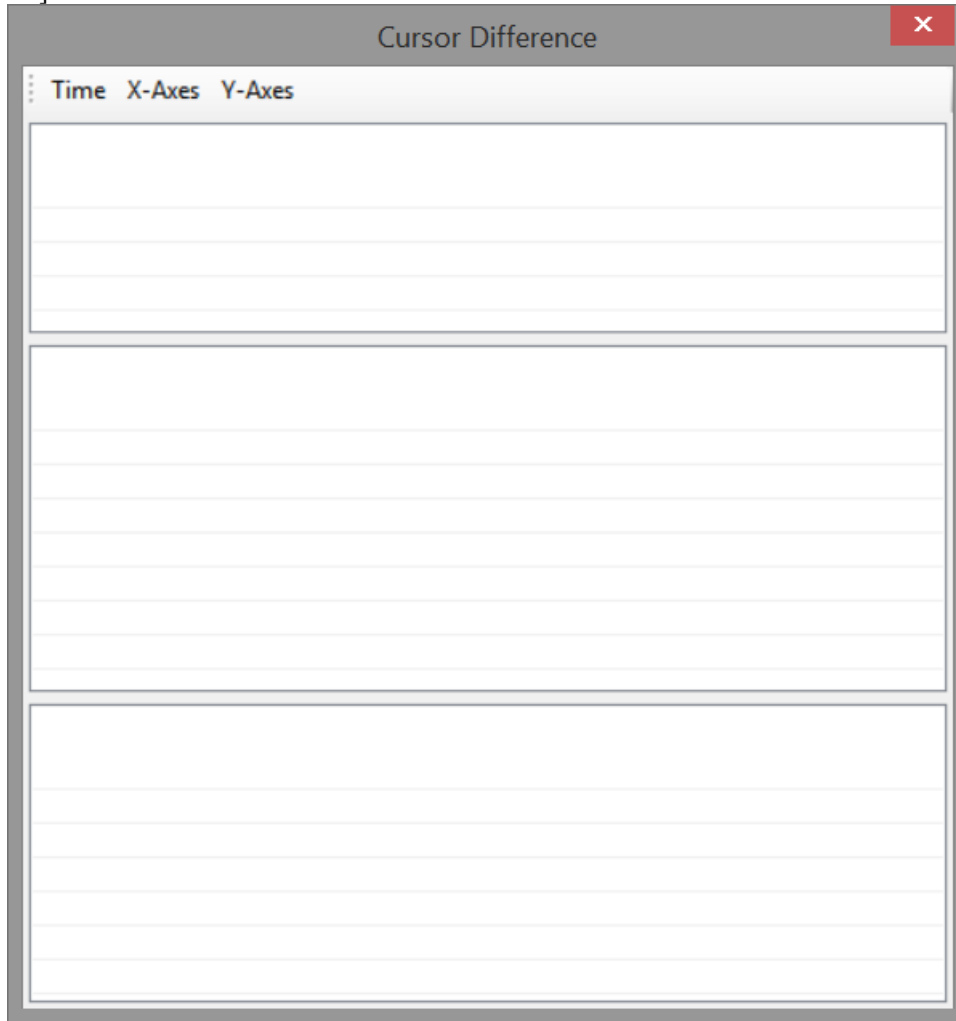

Parameter	Note
Time	Show / hide the status time area (this area is only available when the oscilloscope type is YT).
X-axes	Show / hide Channel/ X-Axes area
Y-axes	Show/ hide Y-Axes area

Note:

- (1) Display rules of status time area:
 - A. Display two time: computer time (PC time); oscilloscope working display time
 - B. Time data source: the value of the x-axis cursor on the x-axis (time axis).
- (2) Channel area display rules:
 - A. Data source: Y-axis register data corresponding to X-axis cursor (data on Y-axis corresponding to X-axis in coordinate system). For example, the time of x-axis cursor on x-axis is 1s, and the data at 1s of y-axis register variable is used as display data source.
 - B. Channel column: displays all the register variables monitored on the oscilloscope.
- (3) Display rules of Y-axes area:
 - A. Data source: data of y-axis cursor on vertical axis.
 - B. For each additional y-axis, a piece of data is added and displayed in the table.

9-4-6. Trigger configuration

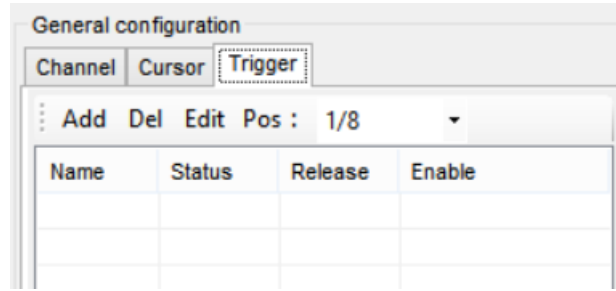

Parameter	Note
Add	Add the trigger
Del	Delete the trigger
Edit	Edit the trigger
Pos	The location on the screen after the trigger is triggered

Note:

(1) Trigger position description: for example, if the trigger position is 1/8, the trigger will stop and will not stop immediately. When the data obtained after trigger can occupy 7/8 of the current interface, the display will stop.

(2) After the trigger is triggered, the state changes to red. At the same time, a dotted line is displayed on the trigger position on the interface to indicate the trigger position.

(3) When the trigger version is XY, it stops immediately after the trigger is triggered.

After click [add], it will show below window:



Parameter	Note
Object	Configured register variables
Condition	Logical relationship between triggers of the same register object
Mode	Trigger edge (Risingedge, fallingedge)
Threshold	Trigger threshold
Action	The action after triggering (StopDisplay, ReStartDisplay)
Enable	Enable the trigger

9-4-7. Oscilloscope application

For example: Xinje XG2 series PLC controls two DS5C servo drivers, the CSP mode is used to make the motor forward and reverse, and the actual position waveform is monitored.

The oscilloscope interface configuration is as follows:



Among them, HD1012 is the mapping of axis 1-6064h, and HD1032 is the mapping of axis 2-6064h.

Click [start] to run the oscilloscope. At this time, the oscilloscope displays the current positions of the two axes. When the axis is not running, it will be two straight lines (the waveform will have a small jitter, and the proportion of ordinates will be obvious when the two axes are running). After the two axes are running, the waveform will change, and the coordinate proportion will be automatically adjusted during the operation of the oscilloscope. If you want to view the waveform, click [stop] and right click [restore to the original zoom ratio], you can view the complete waveform (the waveform will only be displayed within 60s, but all data will be saved. Right click menu [export data] can display data in Excel form).

The waveform is shown as below:

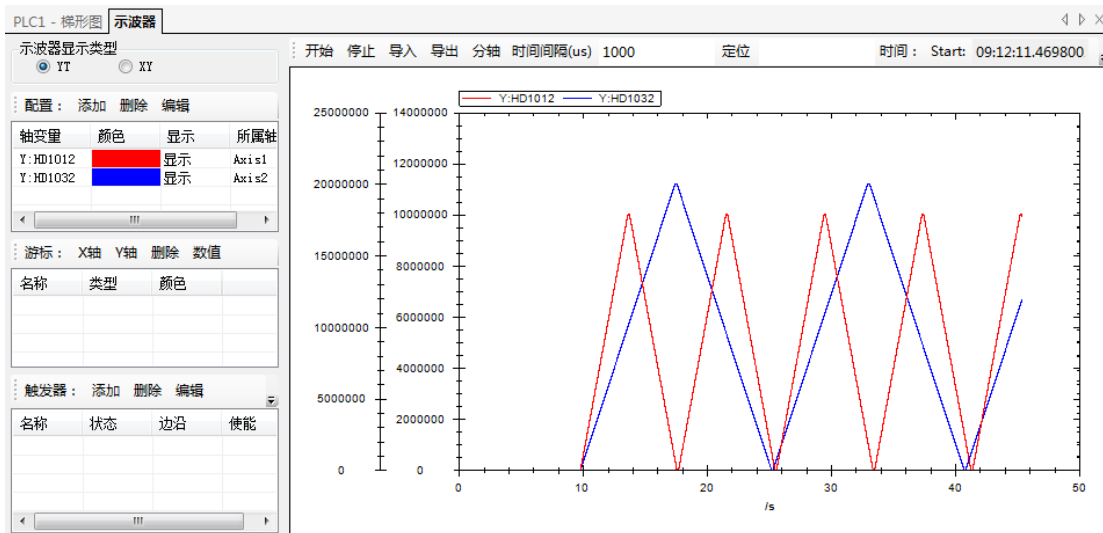

There are two coordinate axes on the left, axis 2 ordinate on the left and axis 1 ordinate on the right.

If it needs to be divided into two coordinate axes, click [sub axis] (the axis variable needs to be set to two different axes).

After [sub axis], the figure is as follows:

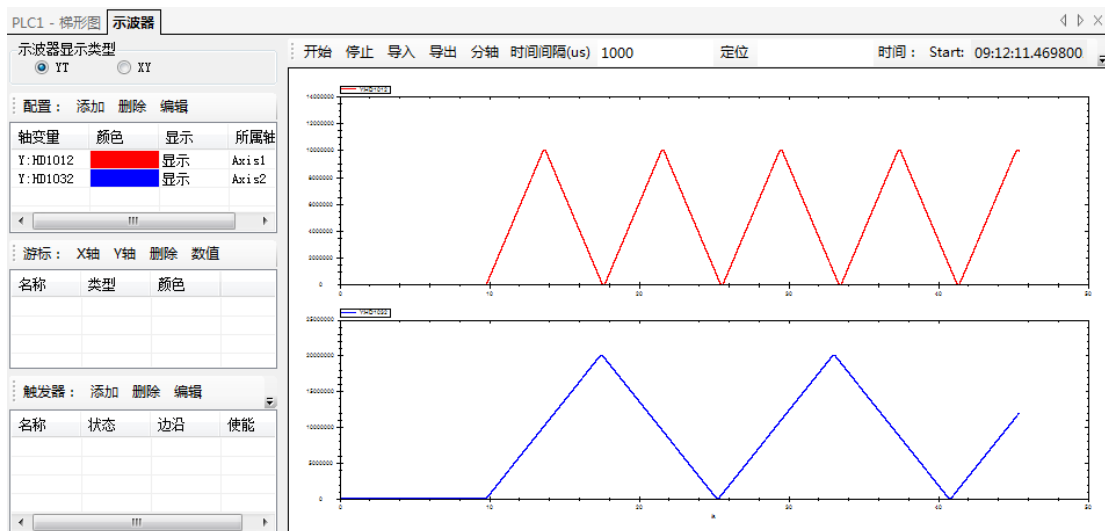

Click the cursor configuration [X axis] [Y axis] to generate a cursor (two cursors are configured for X axis and Y axis in the figure), and the cursor position can be dragged by the mouse.

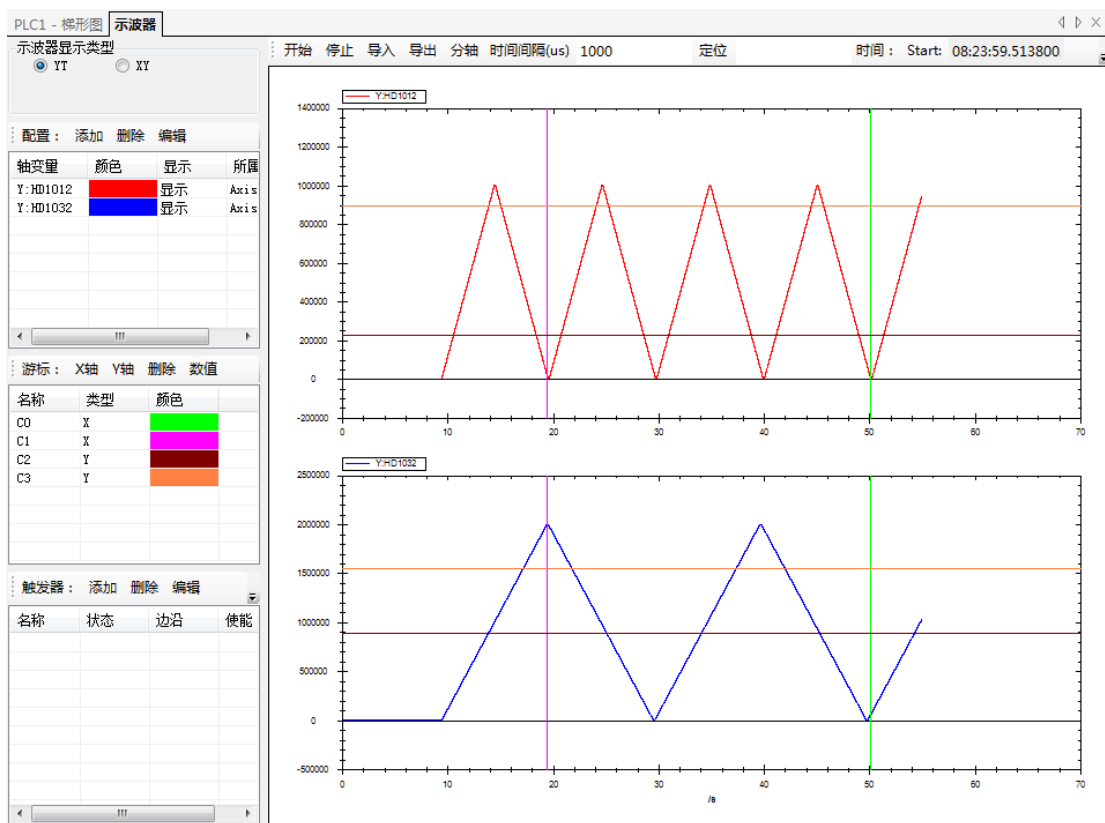

Click the cursor configuration [value] to enter the cursor difference interface, which can monitor the specific value of the register with the cursor.

光标差值			
时间	X轴	Y轴	
StatusTime	C0	C1	C1-C0
Absolute P...	08:24:49:580	08:24:18:902	-30.678s
Chart Posi...	00:50:067	00:19:389	-30.678s
Channel	C0	C1	C1-C0
HD1012	14135	29738	15603
HD1032	45858	1990265	1944407
Y-Axis	C2	C3	C3-C2
Axis	228583.194	897091.24	668508.046
Axis (1)	895594.051	1552946.514	657352.463

StatusTime area:

Absolute Position represents the current actual time (that is, computer time) indicated by the cursor.
Chart Position indicates the working time of oscilloscope (i.e. abscissa of cursor position).

Channel area:

The data in the region represents the value of the register corresponding to the cursor position. Combined with the [status time] area, the real-time value of the register can be monitored. As shown in the figure, the value of register HD1012 in 50.067s is 14135 and that in register HD1032 is 45858. In 19.389s, the value of register HD1012 is 29738 and the value of register HD1032 is 1990265; [C1-C0] represents the difference between the positions of two cursors (Note: when the number of cursors set on one axis is greater than or equal to 2, the cursor difference interface will automatically generate cursor difference data)

Axis area:

The data in the area represents the value corresponding to the cursor of [Y axis], as shown in the figure, the value of [C2] in Axis1 is 228583.194, the value in Axis2 is 895594.051; the value of [C3] in Axis1 is 897091.24, and the value in Axis2 is 1552946.514; and [C3-C2] represents the difference between the corresponding values of the two cursors.

The trigger configuration is show as below:

触发器配置	
对象:	HD1012
条件:	AND
方式:	Risingedge
阈值:	50000
行为:	StopDisplay
使能:	<input checked="" type="radio"/> True <input type="radio"/> False
<input type="button" value="确定"/> <input type="button" value="取消"/>	

Configure two triggers, the object of which are all HD1012, the condition is AND, the mode is rising edge, the threshold value is 50000 and the other is 100000, the action is StopDisplay, enable is True.



Trigger position is set to 4/8, the results of oscilloscope operation are as follows:

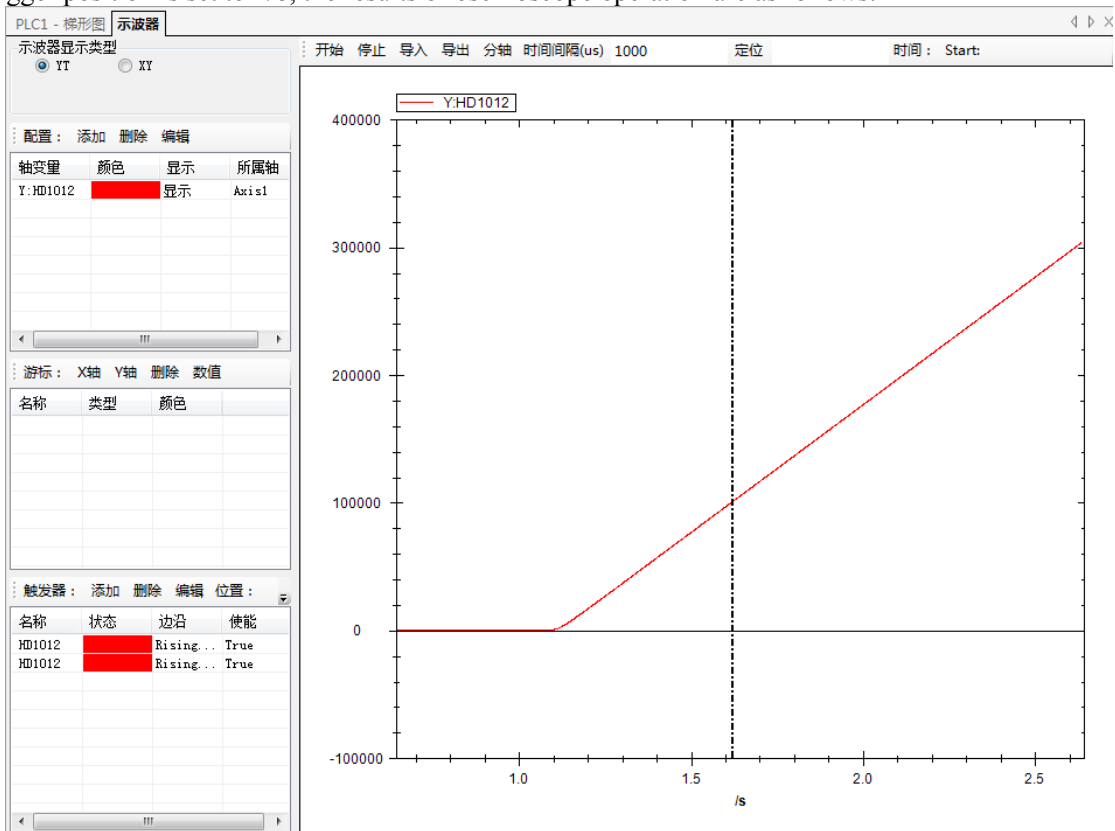

The dotted line in the figure is the trigger position of the trigger. When the trigger is triggered, the trigger position accounts for 4/8 of the current waveform diagram, and the oscilloscope will stop (that is, the dotted line position accounts for half of the current waveform diagram). You can see that the trigger status has turned red, indicating that both triggers have been triggered. If the trigger condition is selected AND, it means that the trigger will stop only when both triggers are triggered, so the trigger position register value is 100000 (if the trigger condition is OR, any one of the triggers will stop if it is triggered; if one of the two trigger conditions is AND the other is OR, the trigger condition will be judged as OR).

10. EtherCAT instruction

10-1. SDO read [EC_SDORD]

(1) Instruction overview

The SDO value is read from the target station and stored in the local register.

SDO read [EC_SDORD]			
Execution condition	Edge triggering	Suitable model	XG2, XDH, XLH
Hardware	V3.6 and above, V3.6.1b and above	Software	V3.6 and above, V3.7.4 and above

(2) Operand

Operand	Function	Range	Type
S0	EtherCAT slave station no.: Station ID	0~63	16-bit constant or single word register
S1	Object index	0x1000~0xffff	16-bit constant or single word register
S2	Object subIndex	0~255	16-bit constant or single word register
S3	Value register		Single word register
S4	Status register		Single word register
S5	Completion flag bit		Bit

(3) Suitable software component

Operand	Word											Bit							
	System								Constant	Module			System						
	D	FD	TD	CD	DX	DY	DM	DS	K/H	ID	QD	X	Y	M	S	T	C	Dnm	
S0	●								●										
S1	●								●										
S2	●								●										
S3	●																		
S4	●																		
S5												●	●	●	●	●	●		

Note: D is D and HD; TD is TD and HTD; CD is CD, HCD, HSCD and HSD; DM is DM and DHM; DS is DS and DHS.
M is M, HM and SM; S is S and HS; T is T and HT; C is C and HC.

(4) Function and action

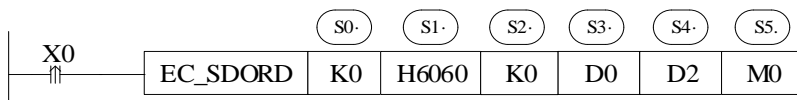

- Instruction meaning: Read the value in slave object dictionary 0x6060: 00 of StationID0 to D0.
- Instruction description: EC_SDORD is used to read the value in slave object dictionary.

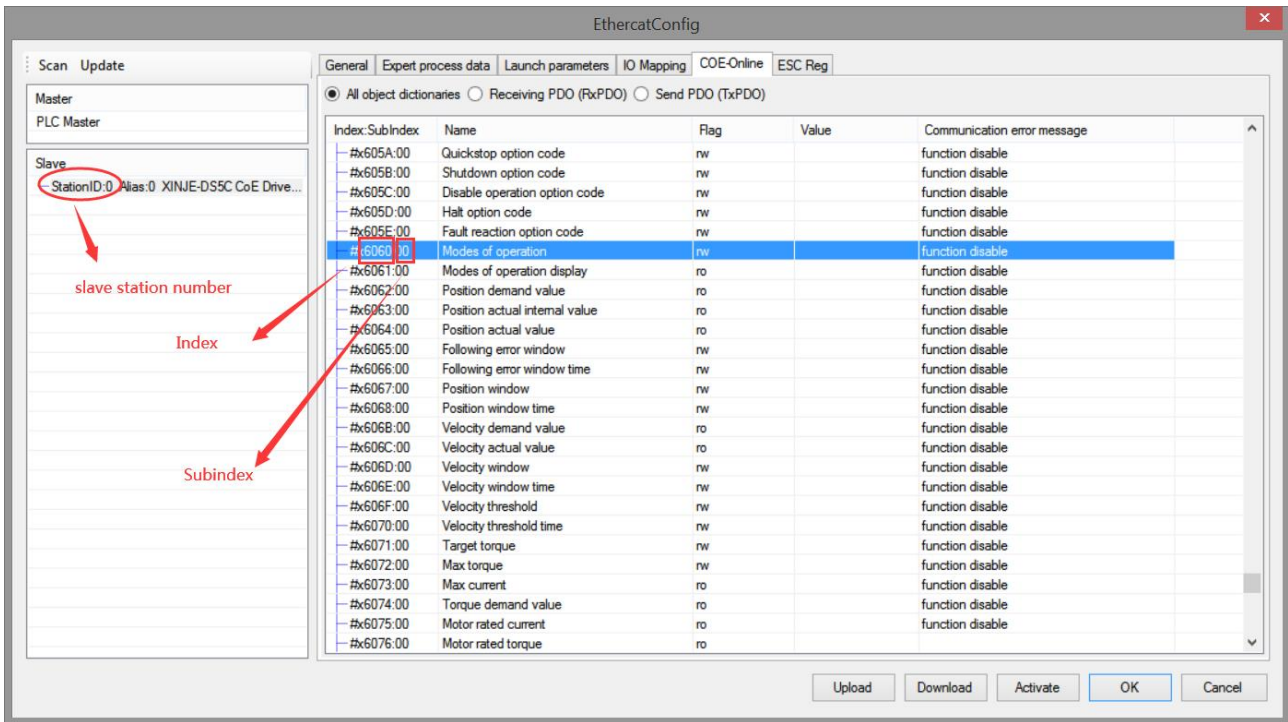

The figure shows the slave and the corresponding object dictionary index, read the value in slave object dictionary 0x6060: 00 of StationID0 to D0.

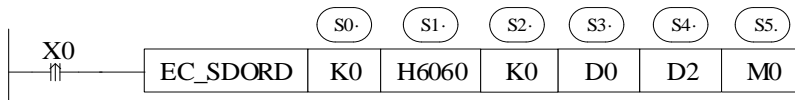

S0: K0 or write 0 in the corresponding register. Note: the first slave station ID is 0, not 1.

S1: H6060 or write K24672 in the corresponding register (H6060).

S2: It is 00 at present, write K0 or 0 in the corresponding register.

S3: The read value is saved in local register D0.

S4: The processing status of instruction.

S5: Instruction processing completion flag. **Whether the value is read successfully or not, it only indicates that the instruction processing is finished and will not reset actively.**

The status code of operand S4 is shown in below table:

Operand	Status code	Meaning	Note
S4	0	Wait for processing	Set to 0 once the instruction is triggered
	1	In processing	
	2	Instruction processing successful	
	3	No instruction	Confirm the firmware and software version is matched
	4	No slave station	Confirm the S0 parameter is correct, check the slave station connection
	5	Slave station busy	
	6	Instruction processing overtime	
	7	Parameter error	Check S1, S2 parameters
	8	Unknown error	Check the program
	20	Write value too large	Check S1, S2 parameters
	21	Slave station in unread status	
	22	the object is write only	
	23	the object is read only	
24	No SDO		

	25	No subindex of SDO	
--	----	--------------------	--

When using EC_SDORD, it should be standardized according to the meaning of instruction operands. The S5 instruction completion flag in the instruction indicates that the instruction processing has been completed when it is set. At this time, other EtherCAT communication instructions can be read and written. No matter the current reading and writing is successful or not, S5 will be set. Therefore, during programming, other EtherCAT communication instructions need to wait for it to be set ON before executing, as shown in the following figure:

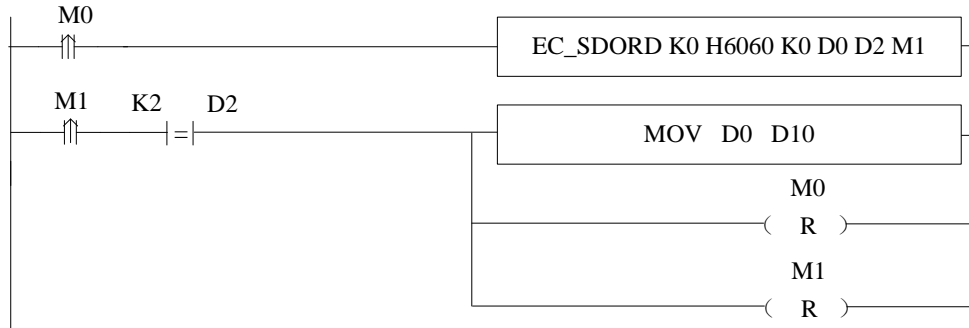

After operand S5 (M1) is set ON, check the status of S4 (D2). According to the status code, if the instruction is processed successfully, the read register can be set value. Since the completion mark M1 will not reset actively, it needs to be reset manually, so RST M1.

10-2. SDO write [EC_SDOWR]

(1) Instruction overview

Write the local register value in target slave station object SDO.

SDO object write [EC_SDOWR]			
Execution condition	Edge triggering	Suitable model	XG2, XDH, XLH
Hardware	V3.6 and above, V3.6.1b and above	Software	V3.6 and above, V3.7.4 and above

(2) Operand

Operand	Function	Range	Type
S0	EtherCAT slave station no.: Station ID	0~63	16-bit constant or single word register
S1	Object index	0x1000~0xffff	16-bit constant or single word register
S2	Object subIndex	0~255	16-bit constant or single word register
S3	Write value register		single word register
S4	write value byte length		16-bit constant or single word register
S5	Status register		single word register
S6	Completion flag bit		Bit

(3) Suitable software component

Operand	Word											Bit							
	System								Constant	Module			System						
	D	FD	TD	CD	DX	DY	DM	DS	K/H	ID	QD	X	Y	M	S	T	C	Dnm	
S0	●								●										
S1	●								●										
S2	●								●										
S3	●																		
S4	●								●										
S5	●																		
S6												●	●	●	●	●	●		

Note: D is D and HD; TD is TD and HTD; CD is CD, HCD, HSCD and HSD; DM is DM and DHM; DS is DS and DHS.
M is M, HM and SM; S is S and HS; T is T and HT; C is C and HC.

(4) Function and action

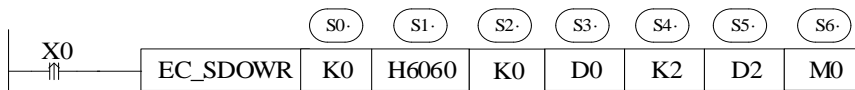

- Instruction meaning: write 2 bytes starting from D0 in slave object dictionary 0x6060:00 of StationID0.
- Instruction description: EC_SDOWR is used to write value in slave object dictionary.

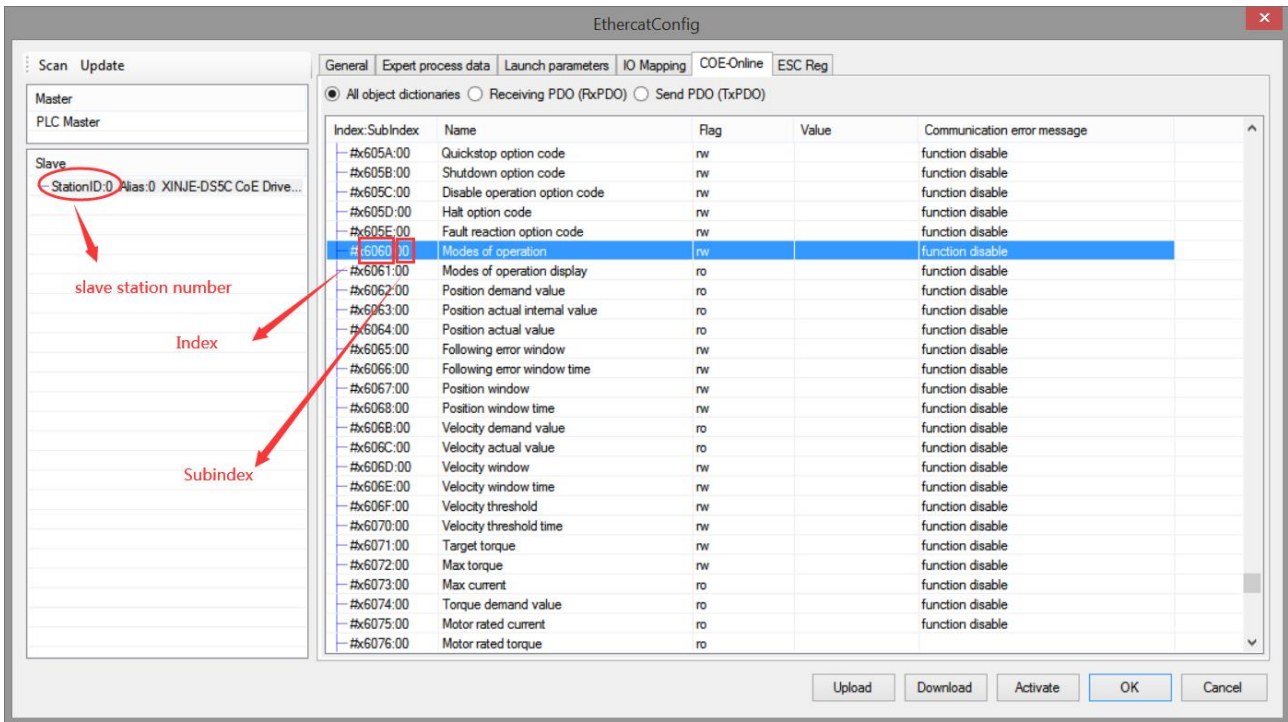

The figure shows the slave and the corresponding object dictionary index.

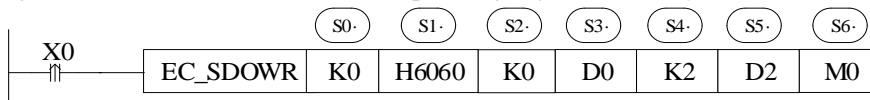

S0: K0 or write 0 in corresponding register. Note: the first station ID is 0 but not 1.

S1: H6060 or write K24672 in corresponding register (H6060).

S2: It is 00 at present, write K0 or 0 in corresponding register.

S3: The value starting from D0 will be written in object SDO.

S4: Write in length, eg. K2 is 2 bytes (one single word register). K4 will occupy two registers eg. D0 D1.

S5: Instruction processing status.

S6: Instruction processing completion flag. **Whether the value is written successfully or not, it only indicates that the instruction processing is finished and will not reset actively.**

The status code of operand S4 is shown in below table:

Operand	Status code	Meaning	Note
S4	0	Wait for processing	Set to 0 once the instruction is triggered
	1	In processing	
	2	Instruction processing successful	
	3	No instruction	Confirm the firmware and software version is matched
	4	No slave station	Confirm the S0 parameter is correct, check the slave station connection
	5	Slave station busy	
	6	Instruction processing overtime	
	7	Parameter error	Check S1, S2 parameters
	8	Unknown error	Check the program
	20	Write value too large	Check S1, S2 parameters
	21	Slave station in unread status	
	22	the object is write only	
	23	the object is read only	
	24	No SDO	
25	No subindex of SDO		

When using EC_SDOWR, it should be standardized according to the meaning of instruction operands. The S6 instruction completion flag in the instruction indicates that the instruction processing has been completed when it is set. At this time, other EtherCAT communication instructions can be read and written. No matter the current reading and writing is successful or not, S6 will be set. Therefore, during programming, other EtherCAT communication instructions need to wait for it to be set ON before executing, as shown in the following figure:

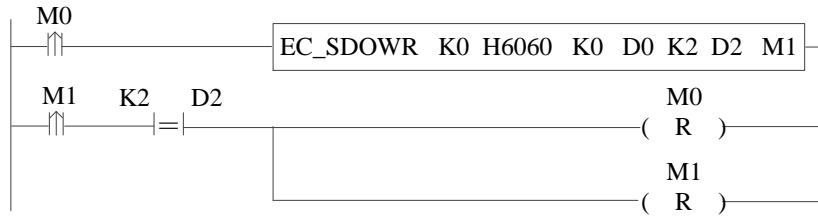

After operand S6 (M1) is set ON, check the status of S5 (D2). According to the status code, if the instruction is processed successfully, the read register can be set value. Since the completion mark M1 will not reset actively, it needs to be reset manually, so RST M1.

10-3. ESC read [EC_REGRD]

(1) Instruction overview

Read ESC register value of target station to local register.

ESC register read [EC_REGRD]			
Execution condition	Edge triggering	Suitable model	XG2, XDH, XLH
Hardware	V3.6 and above, V3.6.1b and above	Software	V3.6 and above, V3.7.4 and above

(2) Operand

Operand	Function	Range	Type
S0	EtherCAT slave station no.: Station ID	0~63	16-bit constant or single word register
S1	ESC register starting address	0x000~0xfff	16-bit constant or single word register
S2	Read byte length	0~255	single word register
S3	Save value register starting address		single word register
S4	Status register		single word register
S5	Completion flag bit		Bit

(3) Suitable softw component

Operand	Word											Bit						
	System								Constant	Module		System						
	D	FD	TD	CD	DX	DY	DM	DS	K/H	ID	QD	X	Y	M	S	T	C	Dnm
S0	●								●									
S1	●								●									
S2	●																	
S3	●																	
S4	●																	
S5												●	●	●	●	●	●	

Note: D is D and HD; TD is TD and HTD; CD is CD, HCD, HSCD and HSD; DM is DM and DHM; DS is DS and DHS.
M is M, HM and SM; S is S and HS; T is T and HT; C is C and HC.

(4) Function and action

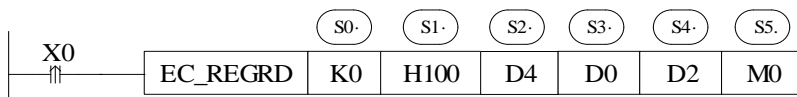

- Instruction meaning: read ESC register value of StationID0 to D0.
- Instruction description: EC_REGRD is used to read ESC value of slave station.

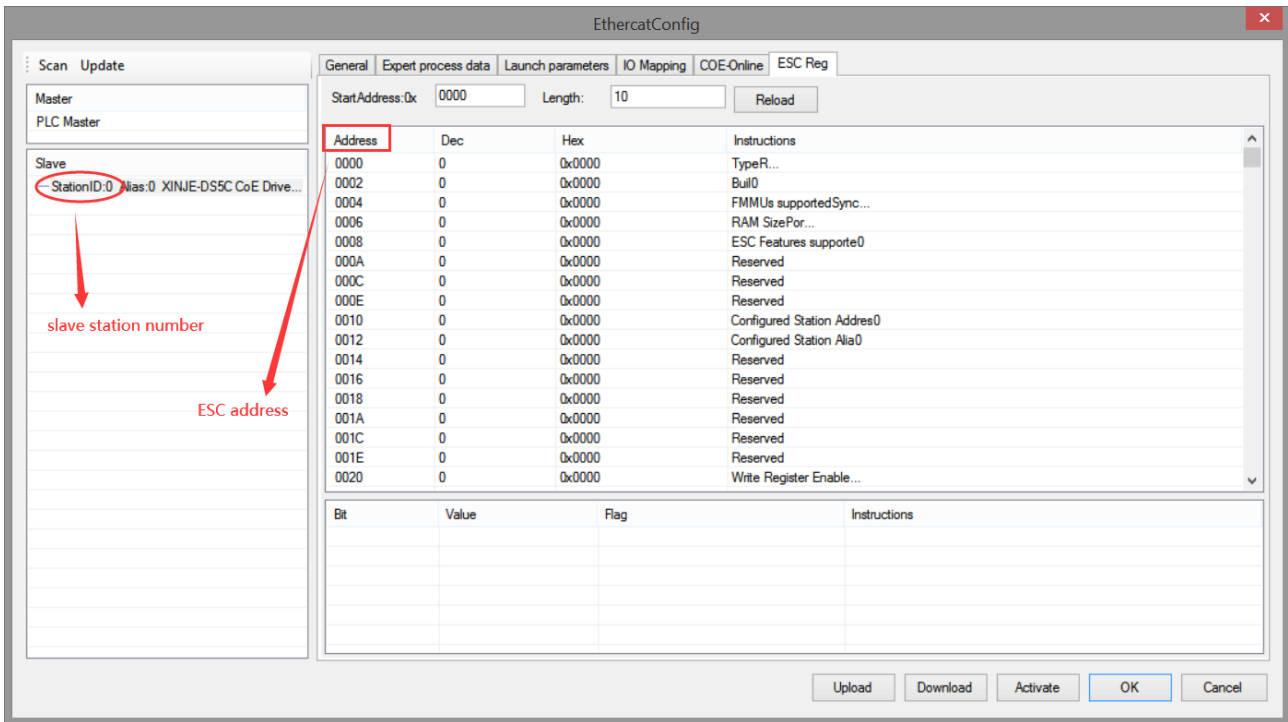

The figure is ESC parameter interface, if it needs to read ESC address H100 of slave station StationID0, please see below example.

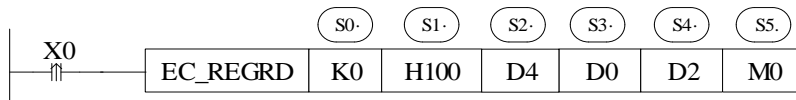

S0: K0 or write 0 in corresponding register. Note: the first station ID is 0 but not 1.

S1: H100 or write K256 (H100) in corresponding register.

S2: ESC address corresponds to one byte. If D4 is written 1, it means read the value of H100 to D0. If it is written 2, it means read H100 H102 to D0 D1.

S3: The read value is saved in local register D0.

S4: The instruction processing status.

S5: Instruction processing completion flag. **Whether the value is written successfully or not, it only indicates that the instruction processing is finished and will not reset actively.**

The status code of operand S4 is shown in below table:

Operand	Status code	Meaning	Note
S4	0	Wait for processing	Set to 0 once the instruction is triggered
	1	In processing	
	2	Instruction processing successful	
	3	No instruction	Confirm the firmware and software version is matched
	4	No slave station	Confirm the S0 parameter is correct, check the slave station connection
	5	Slave station busy	
	6	Instruction processing overtime	
	7	Parameter error	Check S1, S2 parameters
	8	Unknown error	Check the program
	20	Address parameter overlimit	Check S1 parameters
	21	Length invalid	Check S1, S2 parameters
	22	Slave station position error	Check whether there is the slave station
23	Request failure	Retry	

When using EC_REGRD, it should be standardized according to the meaning of instruction operands. The S5 instruction completion flag in the instruction indicates that the instruction processing has been completed when it is set. At this time, other EtherCAT communication instructions can be read and written. No matter the current reading and writing is successful or not, S5 will be set. Therefore, during programming, other EtherCAT communication instructions need to wait for it to be set ON before executing, as shown in the following figure:

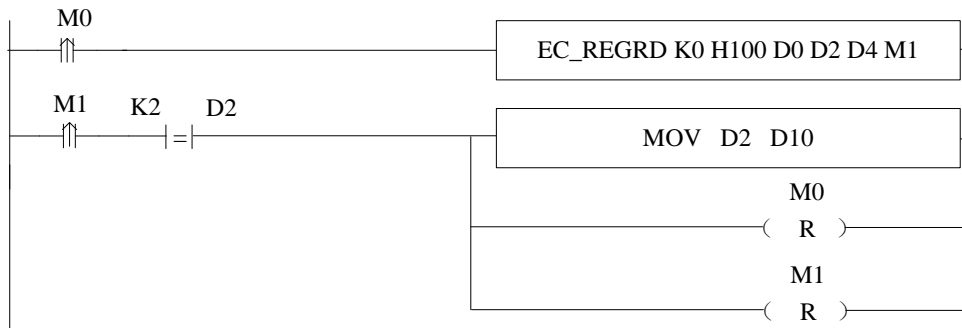

After operand S5 (M1) is set ON, check the status of S4 (D2). According to the status code, if the instruction is processed successfully, the read register can be set value. Since the completion mark M1 will not reset actively, it needs to be reset manually, so RST M1.

10-4. ESC write [EC_ESCWR]

(1) Instruction overview

Write the value in local register to target slave station ESC address.

ESC object write [EC_ESCWR]			
Execution condition	Edge triggering	Suitable model	XG2, XDH, XLH
Hardware	V3.6 and above, V3.6.1b and above	Software	V3.6 and above, V3.7.4 and above

(2) Operand

Operand	Function	Range	Type
S0	EtherCAT slave station no.: Station ID	0~63	16-bit constant or single word register
S1	ESC register starting address	0x000~0xfff	16-bit constant or single word register
S2	Write value starting register		single word register
S3	Write value byte length		16-bit constant or single word register
S4	Status register		single word register
S5	Completion flag bit		Bit

(3) Suitable soft component

Operand	Word											Bit							
	System								Constant	Module			System						
	D	FD	TD	CD	DX	DY	DM	DS	K/H	ID	QD	X	Y	M	S	T	C	Dnm	
S0	●								●										
S1	●								●										
S2	●																		
S3	●								●										
S4	●																		
S5												●	●	●	●	●	●		

Note: D is D and HD; TD is TD and HTD; CD is CD, HCD, HSCD and HSD; DM is DM and DHM; DS is DS and DHS.

M is M, HM and SM; S is S and HS; T is T and HT; C is C and HC.

(4) Function and action

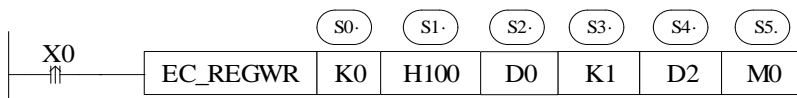

- Instruction meaning: write the value starting from D0 into ESC register of slave station StationID0.
- Instruction description: EC_REGWR is used to write value in slave station ESC address.

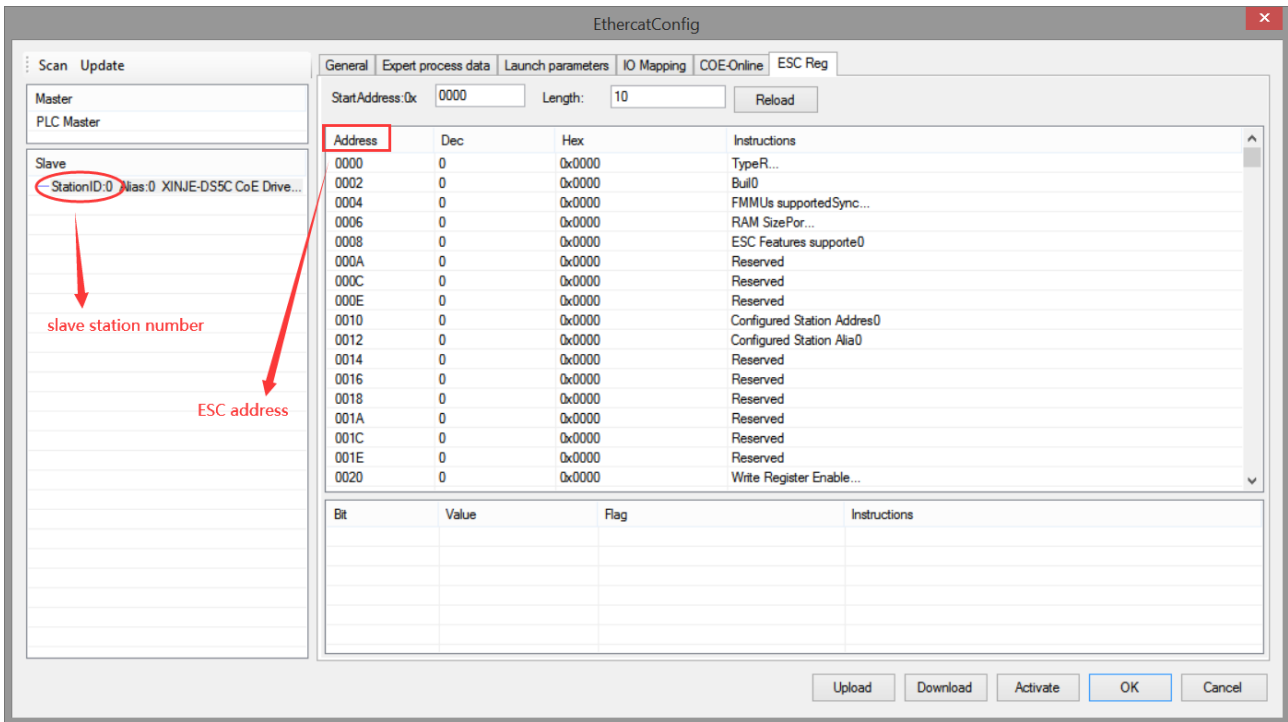

The figure is ESC parameter interface. If it needs to write value in ESC address H100 of slave station ID0, the example is shown as below:

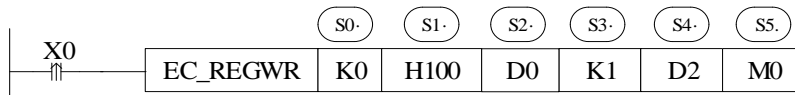

S0: K0 or write 0 in corresponding register. Note: the first station ID is 0 but not 1.

S1: H100 or write K256 (H100) in corresponding register.

S2: write in register starting address.

S3: ESC address corresponds to one byte. K1 means write D0 value to H100. K2 means write D0, D1 value to H100, H102.

S4: instruction processing status.

S5: instruction processing completion flag. **Whether the value is written successfully or not, it only indicates that the instruction processing is finished and will not reset actively.**

The status code of operand S4 is shown in below table:

Operand	Status code	Meaning	Note
S4	0	Wait for processing	Set to 0 once the instruction is triggered
	1	In processing	
	2	Instruction processing successful	
	3	No instruction	Confirm the firmware and software version is matched
	4	No slave station	Confirm the S0 parameter is correct, check the slave station connection
	5	Slave station busy	
	6	Instruction processing overtime	
	7	Parameter error	Check S1, S2 parameters
	8	Unknown error	Check the program
	20	Address parameter overlimit	Check S1 parameters
	21	Length invalid	Check S1, S2 parameters
	22	Slave station position error	Check whether there is the slave station
23	Request failure	Retry	

When using EC_REGWR, it should be standardized according to the meaning of instruction operands. The S5 instruction completion flag in the instruction indicates that the instruction processing has been completed when it is set. At this time, other EtherCAT communication instructions can be read and written. No matter the current reading and writing is successful or not, S5 will be set. Therefore, during programming, other EtherCAT communication instructions need to wait for it to be set ON before executing, as shown in the following figure:

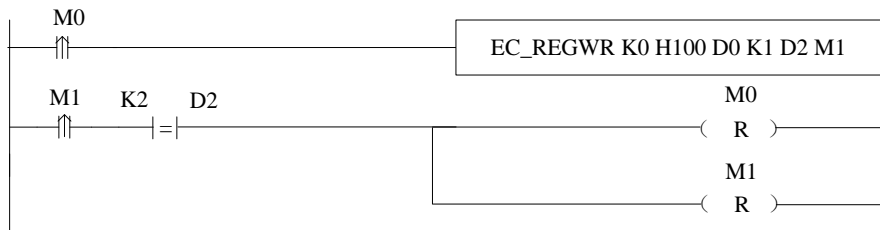

After operand S5 (M1) is set ON, check the status of S4 (D2). According to the status code, if the instruction is processed successfully, the read register can be set value. Since the completion mark M1 will not reset actively, it needs to be reset manually, so RST M1.

10-5. ESM status switch [EC_SETSS]

(1) Instruction overview

Slave station state machine instruction switching.

ESM status switch [EC_ESCWR]			
Execution condition	Edge triggering	Suitable model	XG2, XDH, XLH
Hardware	V3.6 and above, V3.6.1b and above	Software	V3.6 and above, V3.7.4 and above

(2) Operand

Operand	Function	Range	Type
S0	EtherCAT slave station no.: Station ID	0~63, 0xFFFF means switch all the slave stations	16-bit constant or single word register
S1	ESM status	1, 2, 4, 8	16-bit constant or single word register

(3) Suitable soft component

Operand	Word											Bit							
	System								Constant	Module			System						
	D	FD	TD	CD	DX	DY	DM	DS	K/H	ID	QD	X	Y	M	S	T	C	Dnm	
S0	●								●										
S1	●								●										

Note: D is D and HD; TD is TD and HTD; CD is CD, HCD, HSCD and HSD; DM is DM and DHM; DS is DS and DHS.

M is M, HM and SM; S is S and HS; T is T and HT; C is C and HC.

(4) Function and action



- Instruction meaning: switch ESM state machine of slave station ID0 to 8.
- Instruction description: slave station ESM (EtherCAT Status Machine) can be switched through instruction. The state 1: INT, 2: Pre-OP, 4: Safe-OP, 8: OP.
- The instruction must be triggered by the rising edge. After the instruction is executed, the slave station is requested to switch to the specified state. There is no guarantee of immediate switching or successful switching. The switching status can be confirmed by SD [8021 + 20*i]. If it is unable to switch, the status switching error message can be confirmed through SD [8028 + 20 * i].

Appendix

Appendix 1. Command error code

Code	Explanation	Solution
100	Servo cannot be enabled	Confirm the slave status and whether it can be enabled through the bus
101	Duplicate slave station number	Check whether the setting of SFD8002+300*N is repeated
102	Pulse per turn is 0	Check whether the setting of SFD8004+300*N is suitable
103	Movement per turn ≤ 0	Check whether the setting of SFD8008+300*N is suitable
104	Abnormal reducer parameters	Check whether the setting of SFD8014+300*N, SFD8016+300*N is suitable
105	Abnormal port polarity setting	Check whether the setting of SFD8202+300*N, SFD8203+300*N is suitable
106	Port number conflict	Check whether the setting of SFD8200+300*N, SFD8201+300*N is suitable
107	Invalid port number	Check whether the setting of SFD8200+300*N, SFD8201+300*N is suitable
108	Encoder terminal configuration overlimit	Check whether the setting of SFD8006+300*N is suitable
1000	Axis in error stop	A_RST clear the error or close axis enabling reopen
1001	Axis is not enabled	Confirm whether there is A_PWR instruction and whether the instruction was successfully executed
1002	Axis is homing	The axis is in the state of returning to the original point, and will automatically return to the operable state after returning to the original point. If it is not restored to the operational state correctly, please check whether there is an error in the process of returning to the original point
1003	Axis is in stop process	The axis executes A_STOP command and is in the process of stop, you can use the new A_STOP command to interrupt and other motion commands cannot be executed
1004	Specified axis is axis group bound axis	Verify that the specified axis is already a component axis of the axis group and that the axis group is enabled
1005	The axis is in static status	The current command cannot be used when the axis is stationary
1006	The axis is in discrete motion	The current command cannot be used in axis discrete motion
1007	The axis is in continuous motion	The current command cannot be used in continuous axis motion
1008	The axis is in synchronous motion	Verify that the specified axis is in A_GEARIN binding status
1009	The command input parameter error	Check whether the necessary parameters of the instruction are set (some parameters can only be non-negative numbers, and 1009 will be reported when the value is abnormal)
1010	At the soft/hard limit	At the positive limit, it can move to the negative direction; At the negative limit, it can move forward
1011	Abnormal position of modification instruction	Confirm the A_WRITE command position is in the range of soft limit
1012	At the soft/hard limit	At the positive limit, it can move to the negative direction; At the negative limit, it can move forward
1020	The command cannot support buffer	This instruction does not support execution in buffer mode

Code	Explanation	Solution
1021	The command cannot support buffer	The previous instruction does not support the execution of this instruction in buffer mode
1022	The cache is full	One instruction has been cached. No more instructions can be cached
1023	Buffer mode parameter error	Buffer mode error
1030	Axis has no error	Repeat executing A_RST instruction returns this error code
1031	Homing process error	Check whether the parameters related to the homing are set correctly (homing mode is not set, homing speed is not set, etc.)
1032	Not supported control mode	A_MODE specified mode is not supported by the slave station
1033	The denominator is 0	GEARIN command denominator cannot be 0
1034	The current axis is rotation counting	The rotation counting axis only supports A_MOVEA, A_CMOVEA command motion
1035	Axis is in motion	The current command cannot be executed during axis motion
1036	Non CSP mode	The current instruction only supports CSP mode. Confirm whether the 6060h parameter of IO mapping is 8. If not, please switch the mode to CSP through A_MODE command
1037	The current axis is a virtual axis	The current instruction does not support virtual axis execution
1038	The current axis is an encoder axis	The current command does not support encoder axis execution
1039	Same master-slave axis index	Confirm whether the master-slave axis parameters of the command are set correctly
1040	The axis index over limit	Confirm whether the specified axis number of the command exceeds the limit (0 ~ 31) and whether it exceeds the actual real axis, virtual axis and encoder axis numbers
1041	Probe window value error	Confirm whether the window is enabled in the probe instruction A_PROBE. If the window is enabled, whether the window end position is greater than the window start position
1042	Non CSV mode	The current command only supports CSV mode usage
1043	Non CST mode	The current command only supports CST mode usage
1044	GEAROUT invalid	A_GEAROUT cannot be executed in the current state. Example: the specified axis is unbound
1046	Instruction specifies that the register address is an odd number	The specified register address does not support odd numbers
1048	The ZRN command is invalid. It can only return to zero in the opposite direction at the limit	Please set a reasonable homing direction
1049	Error in motion parameter of return to zero configuration	Check whether the parameters in the homing configuration are reasonable
1050	Error in port parameter of return to zero configuration	Check whether the parameters in the homing configuration are reasonable
1051	Z phase numbers configuration error	Check whether the parameters in the homing configuration are reasonable
1052	The zero point signal is too close to the positive and negative limit	Check whether the signal spacing is too short or the equipment fault signal is triggered by mistake
1053	The command is not supported	The current instruction does not support execution in closed-loop mode

Code	Explanation	Solution
	in closed loop mode	
1054	The terminal configurations of the two probes are inconsistent	Check whether the probe parameters are set reasonably
1055	Only when the trigger source is invalid can the Ethernet axis support the slave mode	The pulse axis does not support probe commands, take the slave station as the trigger source
1056	Communication between master station and slave station is not established	Check whether the value of 4041h is correct or whether the master-slave configuration is reasonable
1058	The command is not supported by the pulse axis	The current command only supports EtherCAT axis
1059	Illegal target location	Check whether the parameter SFD8188+300*N setting is reasonable
1060	Invalid homing direction	Check whether the parameter SFD8192+300*N setting is reasonable
2000	Max hard limit	The current axis is at the maximum hard limit. It can run in the negative direction to leave the hard limit
2001	Min hard limit	The current axis is at the min hard limit. It can run in the positive direction to leave the hard limit
2002	Max soft limit	The current axis position is greater than or equal to the maximum soft limit. It can run in the negative direction and go inside the soft limit
2003	Min soft limit	The current axis position is less than or equal to the minimum soft limit. It can move forward to go inside the soft limit
2004	Illegal soft limit value	Confirm whether the maximum soft limit is greater than the minimum soft limit
2005	Servo error	After confirming that the servo error has been removed, execute A_RST to clear error code
2006	Excessive position deviation	The deviation between the given position and the feedback position is too large. Please check whether the position and speed values are set reasonably
2007	Illegal rotation count setting	Confirm whether the rotation counting max value SFD8024+300*N is larger than min value SFD8028+300*N
2008	The rotation count setting exceeds the soft limit	Confirm that the upper / lower limit of rotation count does not exceed the soft limit maximum / minimum value
2009	Unsupported control mode	A_MODE specified mode is not supported by the slave station
2010	Position increment value exceeds the limit	If the axis position changes suddenly, please confirm whether the parameters are reasonable (for example, the position change caused by the absolute mode of the master-slave axis of the CAMIN command)
2011	Servo disconnection	Check the servo connection status and whether the slave station ESM status is OP
2012	Illegal hard limit stop mode	SFD8040+300*N setting value is not supported
2013	Illegal soft limit stop mode	SFD8061+300*N setting value is not supported
2014	When the master and slave is moving, the servo is disconnected	Check the servo connection status and whether the slave station ESM status is OP
2015	Mode modification timeout	Check whether the command parameters are set correctly, and check the state of the axis and the value of 6041
2016	CST\CSV switch to CSP mode timeout	Check whether the command parameters are set correctly, and check the state of the axis and the value of 6041
2017	Instruction buffer full	Instruction buffer full

Code	Explanation	Solution
2018	In closed-loop mode, the following error is greater than the set value	Check whether the relevant parameters are set reasonably
3000	There is not enough space to create a cam table instance	The number of cam table instances cannot exceed 32. Space can be released through CAMTBLDEL command
3001	There is not enough space to create a cam table point	The number of cam table points cannot exceed 65536, and the space can be released through CAMTBLDEL command
3002	There are no points in the cam table	Confirm whether the cam table is downloaded (click download in the cam editing interface of the programming software)
3003	Cam table is in use	Confirm whether the cam table is in motion
3004	Cam function not initialized	Cam table not initialized
3005	Cam table instance does not exist	The cam table instance parameter set in the command does not exist. Please confirm whether the parameter is consistent with the cam table instance parameter obtained by the execution of CAMTBLSEL command
3007	The slave axis is not synchronized	Determines whether the slave axis is in CAMIN motion
3008	Cam table key point does not exist	Confirm whether the key point parameters set in the command are less than the number of points in the corresponding cam table
3009	CAMOUT is invalid	The CAMOUT instruction cannot be executed in the current state. Example: the command axis is in unbound state
3012	Cam table key point write invalid	The specified key point does not support writing
3013	Cam time acquisition failed	Cam time acquisition failed
3014	Key point search failed	The specified key point does not exist
3015	The starting point and ending point of the cubic or quintic curve are the same	Check whether the command parameter setting is reasonable
3016	The current moves to the last point, and the last point cannot be deleted	Check whether the command parameter setting is reasonable
3017	Main axis position setting error	Check whether the command parameter setting is reasonable
3018	Add delete key point trigger mode error	Check whether the instruction trigger mode is correct
3019	Cam curve type error	Check whether the command parameter setting is reasonable
3020	CAMIN direction input error	Check whether the command parameter setting is reasonable
3031	Key point no.0 must be (0,0)	Check whether the command parameter setting is reasonable
5000	Axis group is not enabled	Confirm whether G_PWR command execution is successful
5001	Axis group error stop	After the axis group stops, disable the axis group then enable again
5002	Axis group stop	The axis group is in the process of deceleration stop, and a new movement can be performed after stop
5003	Axis group is in motion	The current command does not support execution in axis group motion
5004	Axis is not enabled	Confirm whether the constituent axes in the axis group have been enabled
5005	Axis has error	Confirm whether there is an error in the constituent axis in the axis group, and perform A_RST command for the specified axis after the error is removed, then enable the axis group again

Code	Explanation	Solution
5006	Axis is in motion	Confirm whether the constituent axes in the axis group are in motion. If they are in motion, wait for the end of the current motion or stop the axis and then enable the axis group through A_STOP/A_HALT command
5007	Axis is not in standstill status	Confirm whether the constituent axes in the axis group are in standstill state. Example: after the axis triggers the hard limit, go out of the hard limit in the opposite direction. At this time, the axis is still in the error state and needs to clear the error through A_RST command, then enable the axis group again
5008	Command input parameter error	Confirm whether the necessary parameters in the instruction have been set (some parameters only support non-negative numbers, and an error will be reported when the parameters are abnormal)
5009	Execution does not support buffer	The current instruction does not support execution in buffer mode
5010	The previous instruction does not support this instruction buffer	The previous instruction does not support the execution of this instruction in buffer mode
5011	The buffer is full	An instruction has been cached. Caching again is not supported
5012	Buffer mode parameter error	Buffer mode parameter error
5013	The buffer is full	An instruction has been cached. Caching again is not supported
5015	Axis group index over limit	The axis group parameter specified by the command is greater than the number of axis groups SFD820. Check the online value in axis group configuration - system setting
5016	Axis group is in motion	Confirm whether the constituent axes in the axis group are in motion. If they are in motion, wait for the end of the current motion or stop the axis and then enable the axis group through A_STOP/A_HALT command
5017	Axis status abnormal	The axis group is enabled, and the single axis in the configured axis is not enabled and stationary
5018	Command input register address error	The specified register address does not support odd numbers
5019	The component axis is in the limit position	Check whether the constituent axes in the axis group are at the limit position
5020	Pathsel buffer operation invalid	PATHSEL parameter abnormal
5021	Pathsel cannot support reset action	PATHMOV is in motion
5022	The distributed data is larger than the buffer size	Check D46226 (Buffer remaining space), ensure that the data in the instruction does not exceed the buffer size
5023	Invalid curve type	Check whether the curve type parameter in the command is legal
5024	G_PATHSEL command parameter abnormal	The command sets the user-defined curve type, and the parameter value must be greater than 100
5025	G_PATHSEL input speed abnormal	Check the target speed in the command
5026	The row number is not monotonic increasing	Ensure the row number of G_PATHSEL command is monotonic increasing
5027	Invalid arc mode	The current arc only supports three-point mode
5030	There are currently other instructions running	There are currently instructions in motion
5031	The buffer has no data	Confirm whether the G_PATHSEL execution is successful

Code	Explanation	Solution
5040	Unable to continue with the original track	G_GOON cannot be executed after forward-looking paused
5041	Axis number not support	Confirm that the constituent axes of the axis group are connected and the ESM status of the specified axis is normal
5050	The command is invalid	The constituent axis of the axis group cannot be encoder axis
5051	X axis max soft limit	Check whether the X-axis of the axis group is at the max soft limit
5052	Y axis max soft limit	Check whether the Y-axis of the axis group is at the max soft limit
5053	Z axis max soft limit	Check whether the Z-axis of the axis group is at the max soft limit
5054	X axis min soft limit	Check whether the X-axis of the axis group is at the min soft limit
5055	Y axis min soft limit	Check whether the Y-axis of the axis group is at the min soft limit
5056	Z axis min soft limit	Check whether the Z-axis of the axis group is at the min soft limit
5057	The radius vector is not perpendicular to the selected plane	Check whether the command parameter setting is reasonable
5058	Wheelbase input value is 0, illegal	Check whether the command parameter setting is reasonable
5059	Axial displacement is 0, illegal	Check whether the command parameter setting is reasonable
5060	Function reload	Check whether the command parameter setting is reasonable
5061	The current state does not allow starting in interrupt mode	Check whether the command parameter setting is reasonable
6000	Duplicate index for constituent axes of the axis group	Check whether the SFD48001+300*N~SFD48003+300*N has duplicate axis number
6001	constituent axes index of the axis group exceeds the number of single axis	Check whether the SFD48001+300*N~SFD48003+300*N exceeds the axis number SFD810
6002	Single axis has error	Single axis in the axis group has error
6003	Single axis is not enabled	Single axis in the axis group is not enabled
6004	Linear speed overspeed alarm	Check whether the linear speed is abnormal. If there is no abnormality, increase the linear speed alarm value appropriately
6005	Acceleration over limit	Not support at the moment
6006	Deceleration over limit	Not support at the moment
6007	Abnormal number of constituent axes	The number of single axes configured for the axis group does not match the model
6008	The hardware channels in the axis group are inconsistent	Confirm whether the SFD8001+300*N of constitute axis is consistent
6009	Counting mode abnormal	Only linear counting is supported. Confirm whether SFD8020+300*N is correct
6010	The constitute axis is not CSP mode	Confirm whether the value of IO mapping 6060h is 8. If not, modify it through A_MODE command
6011	Invalid kinematics type	Confirm whether SFD48000+300*N setting is normal
6012	Axis group given position step	Check whether the position parameters of the command are reasonable
6013	The constitute axis is conflict	The constituent axis cannot be the constituent axis of another enabled axis group
6015	Servo disconnected	Check whether the servo connection is normal and whether the slave ESM state machine is in OP state
6016	Soft limit setting is abnormal	Check whether the maximum value of soft limit of axis group is greater

Code	Explanation	Solution
		than the minimum value
6017	Illegal soft limit stop mode	Check whether the SFD48145+300*N setting is correct
6101	Three points of an arc are collinear	The start point, auxiliary point and end point of the G_CIRCLE command cannot be on the same straight line
6102	Matrix irreversibility	Arc input point position abnormality
6103	The calculated radius is inconsistent	The values from start point to center, auxiliary point to center, and end point to center are inconsistent
6104	The distance between two points is too short	The distance between any two points of starting point, auxiliary point and ending point cannot be less than 0.00001
7001	Illegal input	The instruction parameter cannot be less than 0
7002	The given distance is too short to accelerate to the specified speed	Unreasonable input parameters
7003	The given distance is too short to decelerate to the specified speed	Unreasonable input parameters
7004	Illegal input	The instruction parameter cannot be less than 0
7006	Illegal input	The instruction parameter cannot be less than 0
7100	Cannot decelerate to 0. The original acceleration and deceleration model cannot decelerate to zero through the current model	Check whether the configuration is reasonable
7101	Unknown G code type	Check whether the input G code is reasonable
7102	Unknown acceleration/deceleration type	Check whether the acceleration and deceleration settings are reasonable
7103	Illegal input	Check the axis configuration and axis group configuration parameters
7104	The given distance is too short to accelerate to the specified speed	Unreasonable input parameters
7105	The given distance is too short to decelerate to the specified speed	Unreasonable input parameters
7116	Radius close to 0	Unreasonable input parameters
7117	The starting point, center and end point are collinear	The starting point, center and end point are collinear
7118	The start point, center point and end point coincide	The start point, center point and end point coincide
7119	After correcting the center of the circle, the error value is greater than the allowable value	After correcting the center of the circle, the error value is greater than the allowable value
7120	The included angle of starting point, circle center and ending point is 0	Check whether the command end point and circle center parameters are reasonable
7121	Connecting point distance greater than diameter	Start to end greater than diameter
7122	The vector between the start	The vector between the start point and the end point is not perpendicular

Code	Explanation	Solution
	point and the end point is not perpendicular to the normal vector	to the normal vector
9090	The interpolation buffer is empty	PATHSEL untimely data distribution
9114	Timeout waiting for data from upper computer	Check whether the termination line is missing or whether the parameter type is reasonable

Appendix 2. Register and coil distribution

Type	Type	Space	Starting address	End address
Single axis	M	50	20000	23200
	D	200	20000	32800
	SFD	300	8000	27200
Axis group	M	100	28000	29000
	D	300	46000	49000
	SFD	300	48000	51000

Appendix 3. Servo driver group U parameters

U0-XX

Code	Contents		Unit
U0-00	servo motor speed		Rpm
U0-01	Input speed instruction		Rpm
U0-02	Torque instruction		% rated
U0-03	Mechanical angle		1°
U0-04	Electric angle		1°
U0-05	Bus voltage		V
U0-06	IPM temperature		°C
U0-07	Torque feedback		% rated
U0-08	pulse offset	(0000~9999) *1	Instruction pulse
U0-09		(0000~65535) *10000	
U0-10	Encoder feedback	(0000~9999) *1	Encoder pulse
U0-11		(0000~65535) *10000	
U0-12	input instruction pulse numbers	(0000~9999) *1	Instruction pulse
U0-13		(0000~65535) *10000	
U0-14	position feedback	(0000~9999) *1	Instruction pulse
U0-15		(0000~65535) *10000	
U0-16	encoder accumulated position	(0000~9999) *1	Encoder pulse
U0-17		(0000~65535) *10000	
U0-18	Torque current		0.01A
U0-19	Analog input V-REF value		0.01V
U0-20	Analog input T-REF value		0.01V
U0-21	Input signal status 1		
U0-22	Input signal status 2		
U0-23	output signal status 1		
U0-24	ouput signal status 2		
U0-25	Input pulse frequency	(0000~9999) *1	1Hz
U0-26		(0000~9999) *10000	
U0-37	VREF AD Raw value		
U0-38	TREF AD Raw value		
U0-41	Instantaneous output power		1W
U0-42	Average output power		1W
U0-43	Instantaneous thermal power		1W
U0-44	average thermal power		1W
U0-49	position feedforward		1 command unit
U0-50	speed feedforward		rpm
U0-51	torque feedforward		% rated

U0-52	Instantaneous Bus Capacitor Power		1W
U0-53	Average Bus Capacitor Power		1W
U0-55	Discharge power of instantaneous regenerative braking		1W
U0-56	Average regenerative brake discharge power		1W
U0-57	Absolute encoder present position	(0000~65536) *1	Encoder pulse
U0-58	feedback low 32-bit	(0000~65536) *2 ¹⁶	
Code	Contents		Unit
U0-59	Absolute encoder present position	(0000~65536) *2 ³²	Encoder pulse
U0-60	feedback high 32-bit	(0000~65536)	
U0-61	Xnet communication error amounts		
U0-62	Xnet Communication Waiting Synchronization Frame State Interference		
U0-63	Xnet Communication Waiting for Synchronization Frame State Receiving Data Frame		
U0-64	Xnet Communication Waiting Data Frame State Interference		
U0-65	Xnet Communication Waiting for Data Frame Status Receive Synchronized Frame		
U0-66	Xnet communication CRC parity error		
U0-67	Xnet communication UART error		
U0-68	Xnet communication timeout counting		
U0-69	Communication encoder timeout counting		
U0-88	Motor code reading status		
U0-89	Real-time speed feedback (displaying range -99.99~99.99rpm)		0.01rpm
U0-91	Multi-turn absolute motor circles		
U0-94	Encoder feedback position after calibration	(0000~65536) *1	Encoder pulses
U0-95		(0000~65536) *2 ¹⁶	
U0-96		(0000~65536) *2 ³²	
U0-97		(0000~65536)	
U0-98	High power motor temperature		°C

U1-XX

Code	Contents	Unit
U1-00	present alarm code	
U1-01	present warning code	
U1-02	U phase current when alarming	0.01A
U1-03	V phase current when alarming	0.01A
U1-04	bus voltage when alarming	V
U1-05	IGBT temperature when alarming	°C
U1-06	torque current when alarming	0.01A
U1-07	excitation current when alarming	A
U1-08	position offset when alarming	Instruction pulse
U1-09	speed when alarming	rpm
U1-10	Seconds(low 16-bit) when alarming, cumulated seconds from the first	s

	time power-on	
U1-11	Seconds(high 16-bit) when alarming, cumulated seconds from the first time power-on	s
U1-12	this time running error numbers, counting after power on this time	
U1-13	this time operation warning numbers, counting after power on this time	
U1-14	historical alarm amounts	
U1-15	historical warning amounts	
U1-16	Recent 2nd alarm code	
U1-17	Recent 3rd alarm code	
U1-18	Recent 4th alarm code	
U1-19	Recent 5th alarm code	
U1-20	Recent 6th alarm code	
U1-21	Recent 2nd warning code	
U1-22	Recent 3rd warning code	
U1-23	Recent 4th warning code	
U1-24	Recent 5th warning code	
U1-25	Recent 6th warning code	

U2-XX

Code	Contents	Unit
U2-00	Power on times	
U2-01	series	
U2-02	Model (low 16-bit)	
U2-03	Model (high 16-bit)	
U2-04	out of factory date: year	
U2-05	out of factory date: month	
U2-06	out of factory date: day	
U2-07	Firmware version	
U2-08	Hardware version	
U2-09	Total running time (from the first time power on)	hour
U2-10	Total running time (from the first time power on)	minute
U2-11	Total running time (from the first time power on)	second
U2-12	This time running time (from this time power on)	hour
U2-13	This time running time (from this time power on)	minute
U2-14	This time running time (from this time power on)	second
U2-15	Average output power (from the first time enabled, average power in the process of enabling)	1W
U2-16	Average thermal power (from the first time enabled, average power in the process of enabling)	1W
U2-17	Average bus capacitor filter power (from the first time power on, average power in the process of power on)	1W
U2-20	Device serial no.: low 16-bit	
U2-21	Device serial no.: high 16-bit	

U2-22	Firmware generation date: year	
U2-23	Firmware generation date: month/day	
U2-24	Firmware generation date: hour/minute	

U3-XX

Code	Contents	Unit
U3-00	Motor code (including thermal power parameters) read automatically by driver	-
U3-01	Motor version	-
U3-02	Encoder version	-
U3-70	Automatically read the motor code of the encoder in the motor parameters (only related to the motor code)	-

Appendix 4. EtherCAT communication related servo driver alarm

Appendix 4-1. Alarm list

Alarm code	Explanation	Reason	Solution
E-800	Incorrect ESM requires fault protection	Accept the requires cannot transform from the current status: Init→Safeop Init→OP PreOP→OP ESM status after alarm: when the current status is Init, PreOP, it stops in current status, and transforms to SafeOP when OP. ESC register AL Status Code: 0011h	Confirm the state transformation of the upper device. Set ON SM2013+20*(N-1) or set servo parameter F0-00=1 to clear the alarm.
801	Undefined ESM requires fault protection	Accept status transform requires except the followings: 1: Request Init State 2: Request Pre-Operational State 3: Request Bootstrap State 4: Reauest Safe-operational State 8: Request Operational State ESM status after alarm: when the current status is Init, PreOP, SafeOP, it stops in current status, and transforms to SafeOP when OP. ESC register AL Status Code: 0012h	Confirm the state transformation of the upper device. Set ON SM2013+20*(N-1) or set servo parameter F0-00=1 to clear the alarm.
802	Leading status requires fault protection	Accept the following status transforming requires: 3: Request Bootstrap State ESM status after alarm: Init ESC register AL Status Code: 0013h	Confirm the state transformation of the upper device. Set ON SM2013+20*(N-1) or set servo parameter F0-00=1 to clear the alarm.
803	PLL not finish fault protection	After 1s of synchronization, the phase combination (PLL locking) of communication and servo still cannot be completed. ESM status after alarm: PreOP ESC register AL Status Code: 002Dh	Confirm the setting of DC, and whether transmission delay compensation and deviation compensation are correct. Set ON SM2013+20*(N-1) or set servo parameter F0-00=1 to clear the alarm.
804	PDO watchdog fault protection	For PDO communication (SafeOP or OP status), bit 10 that setting time 0220 (AL Event Request) through ESC register address 0400 (Watchdog Divider) and 0420 (Watchdog Time Process Data) is not ON. ESM status after alarm: Safe OP ESC register AL Status Code: 001Bh	Confirm whether the transmission time of PDO from the upper device is fixed (whether it is interrupted); Confirm that the PDO watchdog detection delay value is too large; Confirm whether there is any problem in the wiring of EtherCAT communication cable and whether there is serious noise on the cable. Set ON SM2013+20*(N-1) or set servo parameter F0-00=1 to clear

			the alarm.
806	PLL fault protection	ESM state is the case that the phase (PLL lock) of communication and servo does not match in SafeOP or OP state. ESM status after alarm: SafeOP ESC register AL Status Code: 0032h	Confirm the setting of DC, and confirm whether transmission delay compensation and deviation compensation are correct. The alarm can be cleared through cutting off the control power or set servo parameter F0-00 = 1.
807	Synchronization signal fault protection	After the completion of synchronization, according to SYNC0 or IRQ, interrupt processing occurs above the setting threshold. ESM status after alarm: SafeOP ESC register AL Status Code: 002Ch	Confirm the setting of DC, and confirm whether transmission delay compensation and deviation compensation are correct. The alarm can be cleared through cutting off the control power or set servo parameter F0-00 = 1.
810	Synchronization period setting error protection	Cannot support the setting period: Synchronization period should be 500us, 1ms, 2ms, 4ms. ESM status after alarm: PreOP ESC register AL Status Code: 0035h	Set correct synchronization period. Set ON SM2013+20*(N-1) or set servo parameter F0-00=1 to clear the alarm.
811	Mailbox setting fault protection	Bad SM0 / 1 setting for mailbox: The receiving and sending area of the mailbox overlaps, overlaps with SM2/3, and the address of the receiving and sending area is odd; The mailbox start address is out of the range of SyncManager0: 1000h~10FFh, SyncManager1: 1200h~12FFh. SyncManager0/1 length (ESC register: 0802h, 0803h/080Ah, 080Bh) setting error: SyncManager0: out of the range of 32~256byte SyncManager1: out of the range of 40~256byte SyncManager0/1 Control Register (ESC register: 0804h/080Ch) setting error conditions: Not set 100110b to 0804h: bit5-0 Not set 100110b to 080Ch: bit5-0 ESM status after alarm: Init ESC register AL Status Code: 0016h	Set SyncManager as ESI file. Set ON SM2013+20*(N-1) or set servo parameter F0-00=1 to clear the alarm.
814	PDO watchdog setting fault protection	PDO watchdog setting error. PDO watchdog trigger is valid (syncmanager: bit6 of register 0804h is 1), the setting value of PDO watchdog detection timeout value (register 0400h, 0402h) does not meet the condition of "communication cycle * 2" ESM status after alarm: PreOP ESC register AL Status Code: 001Fh	Set the watchdog detection timeout value correctly. Set ON SM2013+20*(N-1) or set servo parameter F0-00=1 to clear the alarm.
815	DC setting error protection	The setting of DC is wrong. Bit2-0 of ESC register 0981h (activation) is set to a value other than the following. bit2-0=000b; bit2-0=011b	Confirm the DC setting. Set ON SM2013+20*(N-1) or set servo parameter F0-00=1 to clear the alarm.

		ESM status after alarm: PreOP ESC register AL Status Code: 0030h	
816	SM event mode setting error protection	Unsupported SM time mode is set. 1C32 / 1C33-01 sets values other than 00, 01 and 02. Bit2-0 = 000b of ESC register 0981 and only SM2 of 1C32h-01h and 1C33h-01h are set. ESM status after alarm: PreOP ESC register AL Status Code: 0028h	Confirm that the settings of 1C32h-01h and 1C33h-01h are the same and the values are in 00h, 01h and 02h. Set ON SM2013+20*(N-1) or set servo parameter F0-00=1 to clear the alarm.
817	SyncManager 2/3 setting error protection	SM2/3 is set to error value. The physical address of SM2/3 is set incorrectly (ESC register: 0810h / 0818h): the receiving and sending areas overlap, coincide with SM2/3, the starting address is odd, and the completion address of the starting address is outside the range SM2/3 length setting (ESC register: 0812h/081A) is different from RxPDO, TxPDO. The control register (ESC register: 0814h/081ch) of SM2/3 is not set correctly. Not set 100110b to bit5-0. ESM status after alarm: PreOP ESC register AL Status Code: 001Dh/001Eh	Set correct value of SyncManager2/3 as ESI file. Set ON SM2013+20*(N-1) or set servo parameter F0-00=1 to clear the alarm.
850	TxPDO distribution error protection	Data size of TxPDO mapping exceeds 24 bytes. ESM status after alarm: PreOP ESC register AL Status Code: 0024h	Confirm that the data size of TxPDO mapping is set within 24 bytes. Set ON SM2013+20*(N-1) or set servo parameter F0-00=1 to clear the alarm.
851	RxPDO distribution error protection	Data size of RxPDO mapping exceeds 24 bytes. ESM status after alarm: PreOP ESC register AL Status Code: 0025h	Confirm that the data size of RxPDO mapping is set within 24 bytes. Set ON SM2013+20*(N-1) or set servo parameter F0-00=1 to clear the alarm.
881	Control mode setting error protection	When the set value of 6060h is 0 and the set value of 6061h is 0, the PDS status will be converted to "operation enabled". 6060h is set to not corresponding control mode. In full closed-loop control, 6060h is not set to position control mode. ESM status after alarm: stop in the current ESM status ESC register AL Status Code: 0000h	Confirm the setting value of 6060h. Set ON SM2013+20*(N-1) or set servo parameter F0-00=1 to clear the alarm.
882	ESM requires in operation error protection	When PDS status is "Operation enabled" or "Quick stop active", other ESM status conversion commands are received. ESM status after alarm: based on the requirement of state transformation from upper device. ESC register AL Status Code: 0000h	Confirm the state transformation requirements from the upper device. Set ON SM2013+20*(N-1) or set servo parameter F0-00=1 to clear the alarm.
883	abnormal action	When the input signal EXT1 / EXT2 is not allocated, select the external trigger condition	Set ON SM2013+20*(N-1) or set servo parameter F0-00=1 to clear

	protection	through Touch probe function; The calculation result of electronic gear ratio is 1/1000 to 1000 times; The calculation process of electronic gear ratio, when the denominator or numerator is not signed and more than 64-bit; The final calculation result of electronic gear ratio, when the denominator or numerator is not signed and more than 32-bit; ESM status after alarm: stop in current ESM status ESC register AL Status Code: 0000h	the alarm.
--	------------	------------------------------------------------------------------------------------------------------------------------------------------------------------------------------------------------------------------------------------------------------------------------------------------------------------------------------------------------------------------------------------------------------------------------------------------------------------------	------------

Appendix 4-3. Clear the alarm

Reset method of protection function associated with EtherCAT that can be cleared in case of abnormal (alarm)

The following methods ① ② ③ can be used for abnormal (alarm) clearing no matter which method.

In addition, for protection functions other than EtherCAT association, please refer to the basic function specifications of technical manual.

Method ①: bit4 (Error Ind ACK) of AL control is set to "1".

After that, bit7 of 6040h (control word) is cleared by setting 0 → 1 (sending Fault result command).

After the alarm is cleared, the PDS status is converted from Fault to Switch on disabled.

Method ②: carry out abnormal (alarm) clearing by servo driver (panel F0-00, upper computer software).

After the alarm is cleared, the PDS status is transferred from Fault to Switch on disabled.

Method ③: the external alarm clear input (A-CLR) of servo driver changes from OFF state to ON state.

After the alarm is cleared, the PDS status is migrated from Fault to Switch on disabled.

Appendix 5. Phraseology

Abbreviation	Full name
EtherCAT	Ethernet for Control Automation Technology
COE	CANopen Over EtherCAT
FMMU	Fieldbus Memory Management Unit
SM	Sync Manager
pp	Profile position
pv	Profile velocity
tq	Torque profile
csp	Cyclic synchronous position mode
hm	Homing mode
csv	Cyclic synchronous velocity mode
cst	Cyclic synchronous torque mode
DC	Distributed Clock
SDO	Service Data Object
PDO	Process Data Object
TxPDO	-
RxPDO	-
ESM	EtherCAT State Machine
ESC	EtherCAT Slave Controller
PHY	Physical layer device that converts data from the Ethernet controller to electric or optical signals.
PDI	Process Data Interface or Physical Device Interface
EEPROM	Electrically Erasable Programmable Read Only Memory
ESI	EtherCAT Slave Information, stored in ESI EEPROM (formerly known as SII)

Appendix 6. List of object dictionaries

Appendix 6-1. COE communication area (0x1000-0x1FFF)

Index	Subindex	Name	Unit	Data arange	Data type	Flag	PDO
1000h	00h	device type	-	0-429496795	U32	RO	NO
1001h	00h	error register	-	0-65535	U16	RO	NO
1008h	00h	Device name	-	-	-	RO	NO
1009h	00h	Hardware version	-	-	-	RO	NO
100Ah	00h	software version	-	-	-	RO	NO
1018h	00h	Identity	-	-	-	RO	-
	01h	vendor ID	-	0-255	U8	RO	NO
	02h	product code	-	0-429496795	U32	RO	NO
	03h	Revision	-	0-429496795	U32	RO	NO
	04h	Serial number	-	0-429496795	U32	RO	NO
1600h	00h	1st RxPDO mapping	-	0-24	U8	RW	NO
	01h	SubIndex 001	-	0-4294967295	U32	RW	NO
	02h	SubIndex 002	-	0-4294967295	U32	RW	NO
	03h	SubIndex 003	-	0-4294967295	U32	RW	NO
	-	0-4294967295	U32	RW	NO
	18h	SubIndex 024	-	0-4294967295	U32	RW	NO
1601h	00h	2nd RxPDO mapping	-	0-24	U8	RW	NO
	01h	SubIndex 001	-	0-4294967295	U32	RW	NO
	02h	SubIndex 002	-	0-4294967295	U32	RW	NO
	03h	SubIndex 003	-	0-4294967295	U32	RW	NO
	-	0-4294967295	U32	RW	NO
	18h	SubIndex 024	-	0-4294967295	U32	RW	NO
1602h	00h	3rd RxPDO mapping	-	0-24	U8	RW	NO
	01h	SubIndex 001	-	0-4294967295	U32	RW	NO
	02h	SubIndex 002	-	0-4294967295	U32	RW	NO
	03h	SubIndex 003	-	0-4294967295	U32	RW	NO
	-	0-4294967295	U32	RW	NO
	18h	SubIndex 024	-	0-4294967295	U32	RW	NO
1603h	00h	4th RxPDO mapping	-	0-24	U8	RW	NO
	01h	SubIndex 001	-	0-4294967295	U32	RW	NO
	02h	SubIndex 002	-	0-4294967295	U32	RW	NO
	03h	SubIndex 003	-	0-4294967295	U32	RW	NO
	-	0-4294967295	U32	RW	NO
	18h	SubIndex 024	-	0-4294967295	U32	RW	NO
1A00h	00h	1st TxPDO mapping	-	0-24	U8	RW	NO
	01h	SubIndex 001	-	0-4294967295	U32	RW	NO
	02h	SubIndex 002	-	0-4294967295	U32	RW	NO
	03h	SubIndex 003	-	0-4294967295	U32	RW	NO
	-	0-4294967295	U32	RW	NO
	18h	SubIndex 024	-	0-4294967295	U32	RW	NO
1A01h	00h	2nd TxPDO mapping	-	0-24	U8	RW	NO
	01h	SubIndex 001	-	0-4294967295	U32	RW	NO
	02h	SubIndex 002	-	0-4294967295	U32	RW	NO
	03h	SubIndex 003	-	0-4294967295	U32	RW	NO
	-	0-4294967295	U32	RW	NO
	18h	SubIndex 024	-	0-4294967295	U32	RW	NO
1A02h	00h	3rd TxPDO mapping	-	0-24	U8	RW	NO
	01h	SubIndex 001	-	0-4294967295	U32	RW	NO

	02h	SubIndex 002	-	0-4294967295	U32	RW	NO
	03h	SubIndex 003	-	0-4294967295	U32	RW	NO
	-	0-4294967295	U32	RW	NO
	18h	SubIndex 024	-	0-4294967295	U32	RW	NO
1A03h	00h	4th TxPDO mapping	-	0-24	U8	RW	NO
	01h	SubIndex 001	-	0-4294967295	U32	RW	NO
	02h	SubIndex 002	-	0-4294967295	U32	RW	NO
	03h	SubIndex 003	-	0-4294967295	U32	RW	NO
	-	0-4294967295	U32	RW	NO
	18h	SubIndex 024	-	0-4294967295	U32	RW	NO
1C00h	00h	Sync mangager communication type	-	0-255	U8	RO	NO
	01h	SubIndex 001	-	0-4	U8	RO	NO
	02h	SubIndex 002	-	0-4	U8	RO	NO
	03h	SubIndex 003	-	0-4	U8	RO	NO
	04h	SubIndex 004	-	0-4	U8	RO	NO
1C12h	00h	RxPDO assign	-	0-4	U8	RW	NO
	01h	SubIndex 001	-	1600h-1603h	U16	RW	NO
	02h	SubIndex 002	-	1600h-1603h	U16	RW	NO
	03h	SubIndex 003	-	1600h-1603h	U16	RW	NO
	04h	SubIndex 004	-	1600h-1603h	U16	RW	NO
1C13h	00h	TxPDO assign	-	0-4	U8	RW	NO
	01h	SubIndex 001	-	1A00h-1A03h	U16	RW	NO
	02h	SubIndex 002	-	1A00h-1A03h	U16	RW	NO
	03h	SubIndex 003	-	1A00h-1A03h	U16	RW	NO
	04h	SubIndex 004	-	1A00h-1A03h	U16	RW	NO
1C32h	00h	SM output parameter	-	0-20h	U8	RO	NO
	01h	Synchronization Type	-	0-65535	U16	RW	NO
	02h	Cycle Time	ns	0-4294967295	U32	RW	NO
	03h	SubIndex 003	ns	0-4294967295	U32	RW	NO
	04h	Synchronization Type supported	-	0-65535	U16	RO	NO
	05h	Minimum Cycle Time	ns	0-4294967295	U32	RO	NO
	06h	Calc and Cope Time	ns	0-4294967295	U32	RO	NO
	08h	Get Cycle Time	ns	0-65535	U16	RO	NO
	09h	Delay Time	ns	0-4294967295	U32	RO	NO
	0Ah	Sync0 Cycle Time	-	0-4294967295	U32	RO	NO
	0Bh	SM -Event Missed	-	0-65535	U16	RO	NO
	0Ch	Cycle Time Too Small	-	0-65535	U16	RO	NO
	0Dh	Shift Time Too Short	-	0-65535	U16	RO	NO
	0Eh	SubIndex 0014	-	0-65535	U16	RW	NO
20h	Sync Error	-	0-1	BOOL	RO	NO	
1C33h	00h	SM input parameter	-	0-20h	U8	RO	NO
	01h	Synchronization Type	-	0-65535	U16	RW	NO
	02h	Cycle Time	ns	0-4294967295	U32	RW	NO
	03h	SubIndex 003	ns	0-4294967295	U32	RW	NO
	04h	Synchronization Type supported	-	0-65535	U16	RO	NO
	05h	Minimum Cycle Time	ns	0-4294967295	U32	RO	NO
	06h	Calc and Cope Time	ns	0-4294967295	U32	RO	NO
	08h	Get Cycle Time	ns	0-65535	U16	RO	NO
	09h	Delay Time	ns	0-4294967295	U32	RO	NO
	0Ah	Sync0 Cycle Time	-	0-4294967295	U32	RO	NO
	0Bh	SM -Event Missed	-	0-65535	U16	RO	NO
	0Ch	Cycle Time Too Small	-	0-65535	U16	RO	NO
	0Dh	Shift Time Too Short	-	0-65535	U16	RO	NO

	0Eh	SubIndex 0014	-	0-65535	U16	RW	NO
	20h	Sync Error	-	0-1	BOOL	RO	NO

Appendix 6-2. Servo parameter area

Index	Subindex	Name
2000h	00h	P0-00
2001h	00h	P0-01
2002h	00h	P0-02
2003h	00h	P0-03
...
205Fh	00h	P0-95
2100h	00h	P1-00
2101h	00h	P1-01
2102h	00h	P1-02
2103h	00h	P1-03
...
214Ah	00h	P1-74
2200h	00h	P2-00
2201h	00h	P2-01
2202h	00h	P2-02
2203h	00h	P2-03
...
2263h	00h	P2-99
2300h	00h	P3-00
2301h	00h	P3-01
2302h	00h	P3-02
2303h	00h	P3-03
...
232Eh	00h	P3-46

Index	Subindex	Name
2500h	00h	P5-00
2501h	00h	P5-01
2502h	00h	P5-02
2503h	00h	P5-03
...
2547h	00h	P5-71
2700h	00h	P7-00
2701h	00h	P7-01
2702h	00h	P7-02
2703h	00h	P7-03
...
2715h	00h	P7-21
2800h	00h	P8-00
2801h	00h	P8-01
2802h	00h	P8-02
2803h	00h	P8-03
...
281Ah	00h	P8-26

Appendix 6-3. Servo driver Profile area (0x6000~0x6FFF)

Index	Subindex	Name	Unit	Data range	Data type	Flag	PDO
6007h	00h	Abort connection option code		0-3	I16	RW	NO
603Fh	00h	Error Code		0 - 65535	U16	RO	TxPDO
6040h	00h	Controlword		0 - 65535	U16	RW	RxPDO
6041h	00h	Statusword		0 - 65535	U16	RO	TxPDO
605Ah	00h	Quickstop option code	-	0 - 7	I16	RW	NO
605Bh	00h	Shutdown option code	-	0 - 1	I16	RW	NO
605Ch	00h	Disable operation option code	-	0 - 1	I16	RW	NO
605Dh	00h	Halt option code	-	1 - 3	I16	RW	NO
605Eh	00h	Fault reaction option code	-	0 - 2	I16	RW	NO
6060h	00h	Modes of operation		--128-127	I8	RW	RxPDO
6061h	00h	Modes of operation display		--128-127	I8	RO	TxPDO
6062h	00h	Position demand value [PUU]	Command unit	-2147483648 - 2147483647	I32	RO	TxPDO

6063h	00h	Position actual internal value	pulse	-2147483648 – 2147483647	I32	RO	TxPDO
6064h	00h	Position actual value	Command unit	-2147483648 – 2147483647	I32	RO	TxPDO
6065h	00h	Following error window	Command unit	0 – 4294967295	U32	RW	RxPDO
6066h	00h	Following error time out	1ms	0 – 65535	U16	RW	RxPDO
6067h	00h	Position windows	Command unit	0 – 4294967295	U32	RW	RxPDO
6068h	00h	Position window time	1ms	0 – 65535	U16	RW	RxPDO
6069h	00h	Velocity sensor actual value			I32	RO	TxPDO
606Ah	00h	Sensor selection code				RW	
606Bh	00h	Velocity demand value	Command unit /s	-2147483648 – 2147483647	I32	RO	TxPDO
606Ch	00h	Velocity actual value	Command unit /s	-2147483648 – 2147483647	I32	RO	TxPDO
606Dh	00h	Velocity window	Command unit	0 – 4294967295	U32	RW	RxPDO
606Eh	00h	Velocity window time	1ms	0 – 65535	U16	RW	RxPDO
606Fh	00h	Velocity threshold	Command unit	0 – 4294967295	U32	RW	RxPDO
6070h	00h	Velocity threshold time	1ms	0 – 65535	U16	RW	RxPDO
6071h	00h	Target torque	0.10%	-32768 – 32767	I16	RW	RxPDO
6072h	00h	Max torque	0.10%	0 – 65535	U16	RW	RxPDO
6073h	00h	Max current	0.10%	0 - 65535	U16	RO	NO
6074h	00h	Torque demand value	0.10%	-32768 – 32767	I16	RO	TxPDO
6075h	00h	Motor rated current	1mA	0 – 4294967295	U32	RO	TxPDO
6076h	00h	Motor rated torque	Mn·m	0 – 4294967295	U32	RO	TxPDO
6077h	00h	Torque actual value	0.10%	-32768 – 32767	I16	RO	TxPDO
6078h	00h	Current actual value	0.10%	-32768 – 32767	I16	RO	TxPDO
6079h	00h	DC link circuit voltage				RO	
607Ah	00h	Target position	Command unit	-2147483648 – 2147483647 E208	I32	RW	RxPDO
607Bh	-	Position range limit	-	-	-	-	-
	00h	Number of entries	-	2	U8	RO	NO
	01h	SubIndex 001	Command unit	-2147483648 – 2147483647	I32	RW	RxPDO
	02h	SubIndex 002	Command unit	-2147483648 – 2147483647	I32	RW	RxPDO
607Ch		Home Offset	Command unit	-2147483648 – 2147483647	I32	RW	RxPDO
607Dh	-	Software position limit	-	-	-	-	-
	00h	Number of entries	-	2	U8	RO	NO
	01h	SubIndex 001	Command unit	-2147483648 – 2147483647	I32	RW	RxPDO
	02h	SubIndex 002	Command unit	-2147483648 – 2147483647	I32	RW	RxPDO
607Eh	00h	Polarity	-	0 – 255	U8	RW	NO
607Fh	00h	Max profile velocity	Command unit /s	0 – 4294967295	U32	RW	RxPDO
6080h	00h	Max motor speed	r/min	0 – 4294967295	U32	RW	RxPDO

6081h	00h	Profile velocity	Command unit /s	0 – 4294967295	U32	RW	RxPDO
6082h	00h	End velocity	Command unit /s	0 – 4294967295	U32	RW	RxPDO
6083h	00h	Profile acceleration	Command unit /s ²	0 – 4294967295	U32	RW	RxPDO
6084h	00h	Profile deceleration	Command unit / s ²	0 – 4294967295	U32	RW	RxPDO
6085h	00h	Quick stop deceleration	Command unit / s ²	0 – 4294967295	U32	RW	RxPDO
6086h	00h	Motion profile type	-	-32768 – 32767	I16	RW	RxPDO
6087h	00h	Torque slope	0.1%/S	0 – 4294967295	U32	RW	RxPDO
6088h	00h	Torque profile type	-	-65535	I16	RW	RxPDO
608Fh	-	Position encoder resolution	-	-	-	-	-
	00h	Number of entries	-	2	U8	RO	NO
	01h	SubIndex 001	pulse	1 – 4294967295	U32	RO	NO
	02h	SubIndex 002	r (motor)	1 – 4294967295	U32	RO	NO
6091h	-	Gear ratio	-	-	-	-	-
	00h	Number of entries	-	2	U8	RO	NO
	01h	SubIndex 001	r (motor)	1 – 4294967295	U32	RW	NO
	02h	SubIndex 002	r (shaft)	1 – 4294967295	U32	RW	NO
6092h	-	Feed constant	-	-	-	-	-
	00h	Number of entries	-	2	U8	RO	NO
	01h	SubIndex 001	Command unit	1 – 4294967295	U32	RW	NO
	02h	SubIndex 002	r (shaft)	1 – 4294967295	U32	RW	NO
6093h	00h	Position factor	No supported				
6098h	00h	Homing method	-	-128 – 127	I8	RW	RxPDO
6099h	-	Homing speeds	-	-	-	-	-
	00h	Number of entries	-	2	U8	RO	NO
	01h	SubIndex 001	Command unit /s	0 – 4294967295	U32	RW	RxPDO
	02h	SubIndex 002	Command unit/s	0 – 4294967295	U32	RW	RxPDO
609Ah	00h	Homing acceleration	-	0 – 4294967295	U32	RW	RxPDO
60A3h	-	Profile jerk use	The version cannot support these two parameters, for backup				
60A4h	00h	Profile jerk					
	01h	SubIndex 001					
	02h	SubIndex 002					
60B0h	00h	Position offset	These three parameters are used for driving three loop control. Since the servo underlying algorithm does not support feedforward control, these three parameters are not used, and the modification will not affect the effect.				
60B1h	00h	Velocity offset					
60B2h	00h	Torque offset					
60B8h	00h	Touch probe function	-	0 - 65535	U16	RW	RxPDO
60B9h	00h	Touch probe status	-	0 - 65535	U16	RO	TxPDO
60BAh	00h	Touch probe pos1 pos value	Command unit	-2147483648 – 2147483647	I32	RO	TxPDO
60BBh	00h	Touch probe pos1 neg value	Command unit	-2147483648 – 2147483647	I32	RO	TxPDO
60BCh	00h	Touch probe pos2 pos value	Command unit	-2147483648 – 2147483647	I32	RO	TxPDO
60BDh	00h	Touch probe pos2 neg value	Command unit	-2147483648 – 2147483647	I32	RO	TxPDO

60C0h		Interpolation sub mode select					
60C1h	-	Interpolation data record	No supported				
	00h	Number of entries					
	01h	SubIndex 001					
	02h	SubIndex 002					
60C2h	-	Interpolation time period	-	-	-	-	-
	00h	Number of entries	-	2	U8	RO	TxPDO
	01h	SubIndex 001	-	0- 4294967295	U32	RW	TxPDO
	02h	SubIndex 002	-	0- 4294967295	U32	RW	TxPDO
60C5h		Max acceleration	Command unit /s ²	0 - 4294967295	U32	RW	RxPDO
60C6h		Max deceleration	Command unit/s ²	0 - 4294967295	U32	RW	RxPDO
60E0h	00h	Positive torque limited	No supported				
60E1h	00h	Negative torque limited	No supported				
60E3h	-	Supported homing method	-	-	-	-	TxPDO
	00h	Number of entries	-	1 - 254	U8	RO	TxPDO
	01h	1st supported homing method	-	0 - 32767	U16	RO	TxPDO

	20h	32nd supported homing method	-	0 - 32767	U16	RO	TxPDO
60F2h	00h	Positioning option code					
60F4h	00h	Following error actual value	Command unit	-2147483648 - 2147483647	I32	RO	TxPDO
60FA	00h	Following error actual value	Command unit/s	-2147483648 - 2147483647	I32	RO	TxPDO
60FCh	00h	Position demand value	pulse	-2147483648 - 2147483647	I32	RO	TxPDO
60FDh	00h	Digital inputs	No supported				
60FEh	-	Digital outputs	No supported				
	00h	Number of entries					
	01h	Physical outputs					
	02h	Bit mask					
60FFh	00h	Target velocity	Command unit /s	0 - 4294967295	U32	RW	RxPDO
6502h	00h	Supported drive modes		0-4294967295	U32	RO	TxPDO

Note:

- (1) The object dictionary default value of 607Bh (Position range limited) and 607Dh (software position limited): Min range limited: -2147483648; Max range limited: 2147483647.
This parameter modification does not work.
- (2) 6086h (Motion profile type)
0: step type 1: slope type
This parameter is only fit for HM mode. In PP, PV mode, trajectory planning is directly used for slope type.
In CSP and CSV mode, it is unnecessary to use this parameter, and the trajectory planning is completed in the master station.
- (3) 6088h (Torque profile type)
0: step type 1: slope type
In TQ mode, the slope type is used for torque planning directly, this parameter does not work.

Appendix 7. Key points for attention

- (1) Do not activate the parameters when the servo is enabled. If you want to activate the parameters, please activate them in the servo disabled state, otherwise the correct execution of the action cannot be guaranteed;
- (2) If it is necessary to power down and power on the driver or the host, please power off and power on both, otherwise the correct execution of the action cannot be guaranteed.
- (3) In CSP, CSV and CST modes, do not manually modify the value of 6040h (control word) during motor operation.

XINJE



Wechat ID

WUXI XINJE ELECTRIC CO., LTD.

4th Floor Building 7, Originality Industry
park, Liyuan Development Zone, Wuxi City,
Jiangsu Province

214072

Tel: 400-885-0136

Fax: (510) 85111290